

MR. WALKER IN HIS HOMETOWN

Last Tuesday I went to my hometown to spend the day as usual. It's a small quiet seaside town close to the city that I work and live in. I always look forward to Tuesdays because it's my day off so I can rest and have a good time. Last Tuesday I woke up early, drove about 30 km and reached my parents' cottage at about 7 o'clock in the morning. When I opened the gate of the garden, my father was picking some tomatoes and cucumbers for breakfast. Their dog, Princess was jumping up and down and waving her tail as she was overjoyed to see me. I petted her on her head and then hugged my father. Then we went into the house. My mum was cooking my favourite cheese omelette and setting the table when I entered the kitchen. She was happy to see me. We sat at the table and had a family breakfast. Then I went out for a stroll around the town. The sun was shining brightly and it was quite warm.

I decided to visit the town centre first. As I was walking down Rose Street, I saw my old friend, George. He was trying to change one of his car tyres because it blew out. I stopped to help him. Mr. and Mrs. Davies were passing by and approached us to ask what had happened. I think they were coming from the supermarket because they were carrying a few bags in their hands. After we finished replacing the new tyre with the spare one, George thanked me and drove off. So, I went on walking. When I reached the town center, I went directly into the florist's. The only florist in our town, Mrs. Evans was preparing a huge wreath for a funeral and her assistant was spraying some plants with water. I said good day to them and ordered a nice bouquet of lilies for my mum. I sat on a chair and waited. I was drinking a glass of tea which they offered when Mrs. Evans finished my bouquet. I took it and left. Then I went into the souvenir shop next to the post office to buy gifts for my mum and dad. I was thinking and looking at the items when the shop owner came and asked if I needed any help. He showed me a beautiful tea set for mum and a silver pocket watch for dad. They were gorgeous and their prices were reasonable so I bought them and left the shop. I walked to the town park to sit on a bench and rest for a while. The park was very crowded as usual and I started watching people around me. Sue and her sister, Ann were rollerblading while their parents were doing yoga on their mats. Little Edward was holding an empty ice cream cone and crying as he had dropped his ice cream on the ground. Mr. Lee was sitting under a tree and reading his newspaper. Some boys were playing soccer on the grass. Mrs. Taylor was feeding the birds with crumbs of bread and her husband, Larry was taking photographs. Diane was talking to her son, William angrily as he had pulled a cat's tail. Peter and his sister were running around the park to keep healthy and fit. While I was watching people, I realised that I was missing my hometown more and more each day. I thought I could move back one day. After a short time, I went back home. When I arrived my dad was taking a nap on the sofa and my mum was watching a documentary about polar bears on TV.

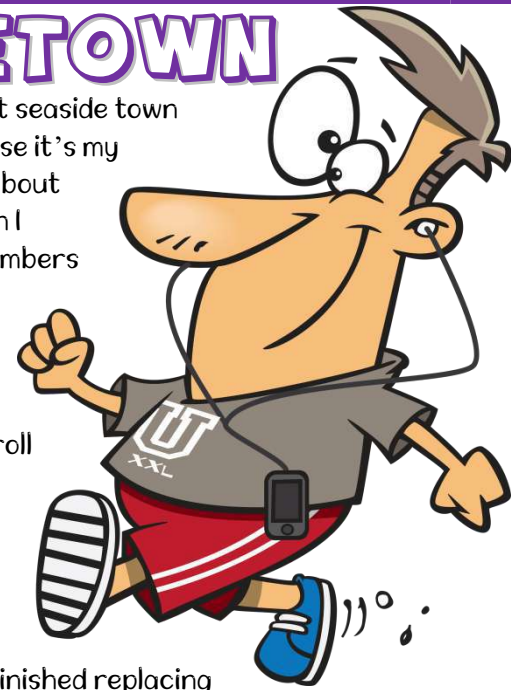

A) Read the text and answer the questions below

1. What was Mr. Walker's father doing when he opened the gate of the garden? _____
2. Who was cooking cheese omelette and setting the table in the kitchen? _____
3. Was Princess sleeping in her bed when Mr. Walker arrived at the cottage? _____
4. Who did Mr. Walker's see while he was walking down Rose Street? _____
5. What was George doing when Mr. Walker stopped to help him? _____
6. Why did Mr. Walker's think Mr. and Mrs. Davies were coming from the supermarket? _____
7. What was Mrs. Evans doing when Mr. Walker went into the shop? _____
8. Who were doing yoga in the park? _____
9. Why was little Edward crying? _____
10. What was Mrs. Taylor doing while her husband was taking photographs? _____
11. Where was Mr. Lee reading his newspaper? _____
12. What was Mr. Walker's mother doing when he came back home from the park? _____

ANSWER KEY

A) Read the text and answer the questions below

1. He was picking some tomatoes and cucumbers for breakfast.
2. Mr. Walker's mother was cooking cheese omelette and setting the table in the kitchen.
3. No, she wasn't.
4. He saw his old friend, George while he was walking down Rose Street.
5. He was trying to change one of his car tyres when Mr. Walker stopped to help him.
6. Because they were carrying a few bags in their hands.
7. She was preparing a huge wreath for a funeral.
8. Sue and Ann's parents were doing yoga in the park.
9. Because he had dropped his ice cream on the ground.
10. She was feeding the birds with crumbs of bread while her husband was taking photographs.
11. He was reading his newspaper under a tree.
12. She was watching a documentary about polar bears on TV.

MR. WALKER IN HIS HOMETOWN

Last Tuesday I went to my hometown to spend the day as usual. It's a small quiet seaside town close to the city that I work and live in. I always look forward to Tuesdays because it's my day off so I can rest and have a good time. Last Tuesday I woke up early, drove about 30 km and reached my parents' cottage at about 7 o'clock in the morning. When I opened the gate of the garden, my father was picking some tomatoes and cucumbers for breakfast. Their dog, Princess was jumping up and down and waving her tail as she was overjoyed to see me. I petted her on her head and then hugged my father. Then we went into the house. My mum was cooking my favourite cheese omelette and setting the table when I entered the kitchen. She was happy to see me. We sat at the table and had a family breakfast. Then I went out for a stroll around the town. The sun was shining brightly and it was quite warm.

I decided to visit the town centre first. As I was walking down Rose Street, I saw my old friend, George. He was trying to change one of his car tyres because it blew out. I stopped to help him. Mr. and Mrs. Davies were passing by and approached us to ask what had happened. I think they were coming from the supermarket because they were carrying a few bags in their hands. After we finished replacing the new tyre with the spare one, George thanked me and drove off. So, I went on walking. When I reached the town center, I went directly into the florist's. The only florist in our town, Mrs. Evans was preparing a huge wreath for a funeral and her assistant was spraying some plants with water. I said good day to them and ordered a nice bouquet of lilies for my mum. I sat on a chair and waited. I was drinking a glass of tea which they offered when Mrs. Evans finished my bouquet. I took it and left. Then I went into the souvenir shop next to the post office to buy gifts for my mum and dad. I was thinking and looking at the items when the shop owner came and asked if I needed any help. He showed me a beautiful tea set for mum and a silver pocket watch for dad. They were gorgeous and their prices were reasonable so I bought them and left the shop. I walked to the town park to sit on a bench and rest for a while. The park was very crowded as usual and I started watching people around me. Sue and her sister, Ann were rollerblading while their parents were doing yoga on their mats. Little Edward was holding an empty ice cream cone and crying as he had dropped his ice cream on the ground. Mr. Lee was sitting under a tree and reading his newspaper. Some boys were playing soccer on the grass. Mrs. Taylor was feeding the birds with crumbs of bread and her husband, Larry was taking photographs. Diane was talking to her son, William angrily as he had pulled a cat's tail. Peter and his sister were running around the park to keep healthy and fit. While I was watching people, I realised that I was missing my hometown more and more each day. I thought I could move back one day. After a short time, I went back home. When I arrived my dad was taking a nap on the sofa and my mum was watching a documentary about polar bears on TV.

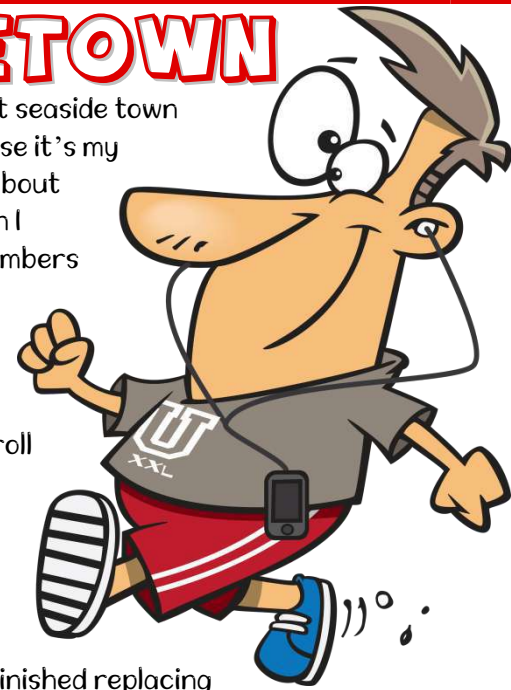

WRITE TRUE OR FALSE

- _____ Mr. Walker lives and works in a city that is about 30 km away from his hometown.
- _____ His mother was cooking a cheese omelette while his father was taking a nap on the sofa.
- _____ His parents' dog, Princess was eating a bone when he went into the garden.
- _____ The sun was shining brightly and it was warm when Mr. Walker left home for a stroll.
- _____ While Mrs. Evans was preparing his order, Mr. Walker was sitting on a chair and drinking tea.
- _____ William's mum was talking to him angrily because he dropped his ice cream on the ground.
- _____ Ann and her sister were rollerblading.
- _____ Larry's wife was feeding the birds with crumbs of bread while he was taking photographs.
- _____ Nobody was doing sports while Mr. Walker was sitting and resting in the park.
- _____ Mr. Walker wants to live in his hometown.

CIRCLE THE CORRECT CHOICE

- Mr. Walker's dad wasn't picking _____ in the garden when he arrived the cottage.
eggplants / tomatoes / cucumbers
- George was trying to _____ one of his car tyres when Mr. Walker saw him and stopped for help.
repair / inflate / change
- Mr. Walker thought that Mr. and Mrs. Davies were coming from the _____.
florist's / supermarket / souvenir shop
- The shop _____ showed Mr. Walker a beautiful tea set and a silver pocket watch.
assistant / owner / attendant
- Mr. Walker was _____ people while he was sitting on a bench and resting.
watching / talking to / greeting
- When Mr. Walker finally turned back home, his dad was _____ on the sofa, but his mum wasn't.
taking a nap / watching TV / waiting for him

ANSWER KEY

Write True or False

1. True
2. False
3. False
4. True
5. True
6. False
7. True
8. True
9. False
10. True

Circle the Correct Choice

1. eggplants
2. change
3. supermarket
4. owner
5. watching
6. taking a nap

WHO BROKE THE WINDOW

Teacher: Oh my god, what happened here? Look at this mess. Who broke this window? Everything was fine just before the break.

Nancy: I don't know Miss Wilson. I was out in the school canteen with Jennifer. We were drinking coffee and eating chocolate muffins.

Teacher: What about you, Donald? Where were you during the break and what were you doing?

Donald: Well, I was in the garden with some boys. We were playing hide and seek together.

Teacher: How about you, girls? Were you all in the classroom during the break time?

Dorothy: No, Miss Wilson. I was in the library during the break. I was looking for a biography book about Thomas Edison, but I couldn't find it.

Amanda: I wasn't in the classroom, either. I was in our maths teacher, Mr. Allen's office. I was talking to him about the maths project. I needed some help with the presentation.

Teacher: Oh, I see. Stephen, Larry and Katherine?

Stephen: I was crying on the bench under the tree in the garden because I fell down while I was playing tag with my friends and hurt my knee.

Larry: I was running back home during the break, Miss Wilson. I forgot to take my science notebook this morning and I went back home and took it.

Katherine: I was in the music room with a few friends. Our music teacher, Mr. Hall was playing the piano and we were listening to him.

Teacher: Were you sitting in the classroom, Kevin?

Kevin: No, I wasn't. I was in the school lab during the break. I was helping my younger brother and his classmates with doing an experiment.

Teacher: How about you, Samantha and Bradley? Where were you and what were you doing?

Samantha: I was drawing a picture of the pine tree and the birdhouse near the playground.

Bradley: I was preparing a poster about nature and endangered animals in the library with a group of friends. We were trying to find some effective slogans.

Teacher: That's so nice, Bradley. I like the idea. I can help you with it if you want. How about you, Frank? Were you out during the break?

Frank: No, I wasn't, Miss Wilson. Well, I know it's not right, but Ryan and I was playing baseball in the classroom during the break and I broke the window. I'm so sorry, Miss Wilson.

Ryan: Yes, teacher. We are very sorry. We can have the window glass replaced if you wish.

Teacher: OK, Frank and Ryan. I think I'll need to talk to you and your parents for it.



A) Read the dialogue and write **TRUE** or **FALSE**

1. Donald was just sitting on a bench in the school garden during the break. (_____)
2. Amanda was talking to Mr. Allen because she needed some help with a project. (_____)
3. Stephen was playing tag with his friends when he fell down and hurt his knee. (_____)
4. Frank was playing baseball, but Ryan wasn't during the break. (_____)
5. Bradley and her friends were working on a poster for endangered animals. (_____)

B) Read the dialogue and **answer the questions**

1. What were Nancy and Jennifer doing during the break? _____
2. Who was drawing a picture of the pine tree and the birdhouse? _____
3. Why was Larry running back home? _____
4. What was Kevin doing in the school lab? _____
5. Why was Stephen crying on the bench under the tree? _____
6. Who was playing the piano in the music room? _____
7. What was Frank doing when he broke the window? _____

ANSWER KEY

A) Read the dialogue and write TRUE or FALSE

1. False
2. True
3. True
4. False
5. True

B) Read the dialogue and answer the questions

1. They were drinking coffee and eating chocolate muffins in the school canteen.
2. Samantha was drawing a picture of the pine tree and the birdhouse.
3. Because he forgot to take his science notebook this morning.
4. He was helping his younger brother and his classmate with doing an experiment.
5. Because he fell down and hurt his knee while he was playing tag with his friends.
6. Mr. Hall was playing the piano in the music room.
7. He was playing baseball with Ryan in the classroom.

PAST CONTINUOUS TENSE

1. Mr. Roberts and his daughter _____ (walk) in the park at 7 a.m. yesterday morning.
2. Janice _____ (not listen) to her English teacher when he asked her a hard question.
3. Who _____ (make) that noise while Billy _____ (read) the paragraph?
4. The Johnsons _____ (watch) a horror film when the doorbell rang.
5. I _____ (drive) to the office when I saw an accident on Palm Street.
6. _____ you _____ (sleep) when I texted you about the party yesterday afternoon?
7. Where _____ you _____ (go) at 10 p.m. last night? I saw while you _____ (leave).
8. My grandfather _____ (plant) an olive tree while we _____ (water) the flowers.
9. Isabella _____ (take) a shower when the electricity went off this morning.
10. What _____ Alan and Beverly _____ (do) when their father came into the room?
11. Why _____ you _____ (shout) at Noah and Randy a few hours ago?
12. I _____ (not do) anything when my best friend, Charlotte offered to go to the cinema.
13. We _____ (eat) fish and chips in the restaurant at about 1 p.m. yesterday.
14. The detective _____ (question) three men for the bank robbery last night.
15. Mr. Cooper _____ (repair) a gold watch when I went into his shop.
16. It _____ (not rain) outside when we left home. So we didn't take our umbrellas.
17. Who _____ you _____ (talk) with when I met you in the shopping mall yesterday?
18. He _____ (look for) a puppy in the animal shelter when he suddenly decided to adopt a cat with three kittens.
19. Judy and Grace _____ (not read) their books in the classroom this morning. They _____ (write) their essays.
20. My parents _____ (prepare) breakfast while my sister and I _____ (set) the table at about 7 a.m. this morning.
21. _____ your grandma _____ (take) a nap on the sofa a few hours ago?
22. She _____ (listen) to music an hour ago.

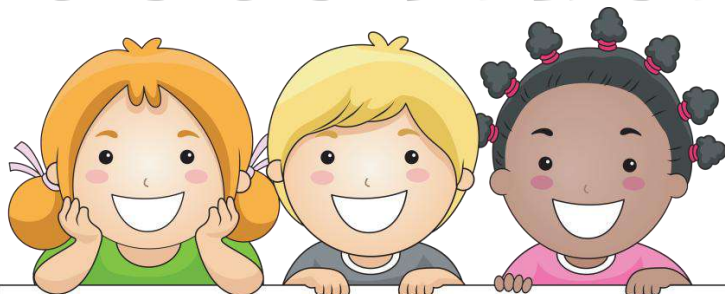

Fill in the blanks with the correct forms of the verbs in brackets to complete the sentences

23. I was very scared tonight because I thought a man _____ (follow) me.
24. Lawrence _____ (walk) down the street when he found a hundred dollar bill.
25. We _____ (have) dinner when aunt Judy knocked the door yesterday evening.
26. The footballers _____ (not play) well so their coach yelled at them in anger.
27. My cousins _____ (not swimming), but they _____ (sunbathe) on the beach when a shark appeared on the shore.
28. Diane _____ (swing) in the playground when it suddenly started snowing.
29. Mrs. Ward _____ (feed) the cats on the pavement when the earthquake happened.
30. His sons _____ (not sleep) in their beds at 11 p.m. last night. They _____ (drink) orange juice and playing tic-tac-toe.
31. Mr. Hughes _____ (sweep) the leaves in the driveway when the postman came.
32. What _____ the students _____ (watch) on the smartboard when the teacher came?
33. The boss _____ (talk) on the phone when the secretary brought the reports.
34. My mother _____ (cook) spaghetti and fried chicken when I last saw her.
35. At 5 o'clock yesterday afternoon, my friends and I _____ (play) hide and seek.
36. The police officer asked "What _____ the man _____ (wear) when he entered the bank?"
37. Nobody _____ (play) on the monkey bars when I went to the park this morning.
38. It _____ (hail) heavily this afternoon so a lot of birds came my balcony.
39. My grandparents _____ (watch) the news when their guests arrived home for dinner.

ANSWER KEY

1. were walking
2. wasn't listening
3. was making / was reading
4. were watching
5. was driving
6. Were / sleeping
7. were / going / were leaving
8. was planting / were watering
9. was taking
10. were / doing
11. were / shouting
12. wasn't doing
13. were eating
14. was questioning
15. was repairing
16. wasn't raining
17. were / talking
18. was looking for
19. weren't reading / were writing
20. were preparing / were setting
21. was / taking
22. was listening
23. was following
24. was walking
25. were having
26. weren't playing
27. weren't swimming / were sunbathing
28. was swinging
29. was feeding
30. weren't sleeping / were drinking
31. was sweeping
32. were / watching
33. was talking
34. was cooking
35. were playing
36. was / wearing
37. was playing
38. was hailing
39. were watching

PAST CONTINUOUS TENSE



A) Fill in the blanks with **was** or **were** to complete the sentences below.

1. William _____ doing his English homework when I arrived home in the afternoon.
2. _____ Sarah and David tidying their bookcases?
3. Where _____ your dad going at 7:45 this morning?
4. We _____ just listening to music when you came.
5. The children _____ making a snowman in front of the school building when their teacher saw them.
6. I didn't hear you, mum. I _____ listening to music in my room with my brother, Lawrence.
7. They _____ playing volleyball when Judy fell and broke her left arm yesterday.
8. My grandma _____ looking at the family album when she suddenly started crying.
9. Mrs. Webb _____ riding her bicycle on the street when she met one of her old friends.
10. I _____ reading a science magazine when I found an interesting article on global warming and seals.

B) Fill in the blanks with **was**, **wasn't**, **were** or **weren't** to complete the sentences below.

1. I _____ having a shower half an hour ago, but the water wasn't warm enough. Is there a problem?
2. Donna _____ listening to the teacher, so she couldn't give the correct answer to this question.
3. Lucy and Ted _____ going to the playground. They were actually going to the amusement park.
4. My mother _____ making a chocolate cake when returned from school yesterday afternoon.
5. We _____ sleeping at 11 p.m. last night. There was an exciting film on TV and we were watching it.
6. Kenneth _____ flying his kite with some friends when I last saw him in the football pitch.
7. The Thompsons _____ celebrating Ronald's tenth birthday when the electricity went off.
8. She _____ talking with her boss when a man with a funny hat and suit came into the office.
9. Jeffrey _____ driving fast, so it was not his fault.
10. Jacop and Cynthia _____ walking to school when they heard the explosion last Wednesday.

C) Answer the questions about yourself.

1. What were you doing at eleven o'clock last night?

2. What was your dad doing at 8 o'clock yesterday evening?

3. What was your mum doing at 7 a.m. this morning?

4. Were you doing homework at 5 o'clock yesterday afternoon?

5. Were you watching TV at nine o'clock yesterday morning?

D) Rewrite the sentences with the subjects in brackets.

1. Sharon was swimming in the river when she saw a small turtle under the water. (The boys) _____
2. The students weren't doing anything when Mrs. Hall came into the classroom. (I) _____
3. Paul and Mark were building a kennel for their dog, Oscar at about 9 a.m. (Jason) _____
4. I was fishing in the lake when a frightening storm started yesterday. (Two friends) _____
5. We were walking past the police station when a car crashed into a lorry. (My mum) _____
6. Our neighbour was walking to work because there was a problem with her car. (Mr. Parker) _____
7. They weren't playing football when I came because it was raining heavily. (George) _____
8. Our physical education teacher was skipping rope when the bell rang. (The girls) _____
9. My parents were having a barbeque when suddenly a fire started in the garden. (Mrs. Cox) _____
10. When the earthquake happened, Mr. Knight was sleeping in his bed. (The kids) _____

E) Read the answers and write questions to the **underlined** words.

1. _____ ?
The teachers were playing table tennis **in the gym**.
2. _____ ?
I was talking to **Mr. Robinson** a few minutes ago.
3. _____ ?
Karen was watching **an exciting action film** when she fell asleep on the sofa last night.
4. _____ ?
Yes, all the kids were laughing while they were watching the new cartoon.
5. _____ ?
No, Charles and Thomas weren't fighting each other in the classroom.
6. _____ ?
Mrs. Collins **was preparing dinner** when the guests arrived at the cottage.
7. _____ ?
Eric was going **to the new shopping centre** when he bumped into his primary school teacher.
8. _____ ?
Helen and Anna were sitting on the bench when the robbers entered the bank.

ANSWER KEY

A) Fill in the blanks with **was** or **were** to complete the sentences below.

- | | | |
|---------|---------|---------|
| 1. was | 5. were | 9. was |
| 2. Were | 6. was | 10. was |
| 3. was | 7. were | |
| 4. were | 8. was | |

B) Fill in the blanks with **was**, **wasn't**, **were** or **weren't** to complete the sentences below.

- | | | |
|------------|------------|-----------|
| 1. was | 5. weren't | 9. wasn't |
| 2. wasn't | 6. was | 10. were |
| 3. weren't | 7. were | |
| 4. was | 8. was | |

C) Answer the questions about yourself.

Your own answers

D) Rewrite the sentences with the subjects in brackets.

1. The boys were swimming in the river when they saw a small turtle under the water.
2. I wasn't doing anything when Mrs. Hall came into the classroom.
3. Jason was building a kennel for his dog, Oscar at about 9 a.m.
4. Two friends were fishing in the lake when a frightening storm started yesterday.
5. My mum was walking past the police station when a car crashed into a lorry.
6. Mr. Parker was walking to work because there was a problem with his car.
7. George wasn't playing football when I came because it was raining heavily.
8. The girls were skipping rope when the bell rang.
9. Mrs. Cox was having a barbeque when suddenly a fire started in the garden.
10. When the earthquake happened, the kids were sleeping in their beds.

E) Read the answers and write questions to the underlined words.

1. Where were the teachers playing table tennis?
2. Who were you talking to a few minutes ago?
3. What was Karen watching when she fell asleep on the sofa last night?
4. Were all the kids laughing while they were watching the new cartoon?
5. Were Charles and Thomas fighting each other in the classroom?
6. What was Mrs. Collins doing when the guests arrived at the cottage.
7. Where was Eric going when he bumped into his primary school teacher.
8. Who were sitting on the bench when the robbers entered the bank.

PAST CONTINUOUS-MULTIPLE CHOICE QUESTIONS

CHOOSE THE CORRECT OPTION

1. Mr. Robinson _____ the guitar when I went into the living room.

- a) were playing
- b) weren't playing
- c) was playing
- d) wasn't playing



2. I stepped on chewing gum while I _____ to work yesterday morning.

- a) was walking
- b) was driving
- c) were walking
- d) were driving



3. Three friends _____ skiing happily this afternoon when they crashed into each other and fell.

- a) wasn't
- b) weren't
- c) was
- d) were



4. Mrs. Martinez was reading a mystery novel at 8 p.m. _____.

- a) at the moment
- b) next weekend
- c) yesterday evening
- d) tomorrow morning



5. My parents _____ talking to each other calmly. They _____ shouting at each other.

- a) weren't / weren't
- b) weren't / were
- c) were / weren't
- d) were / were



6. Bob: _____ were you doing when it started hailing?

Sue: I was playing out.

- e) What
- f) Where
- g) Why
- h) Which



7. Michael _____ a boiled egg, cheese and olives for breakfast this morning.

- a) wasn't eating
- b) weren't eating
- c) was eating
- d) were eating



8. I know that our enemies _____ me when I was lost in the forest yesterday.

- a) was helping
- b) were helping
- c) was watching
- d) were watching

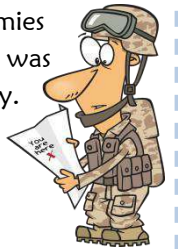

9. I fell down and hurt my arm last Saturday because I _____ ice skating well.

- a) was
- b) wasn't
- c) were
- d) weren't



10. Some of the patients _____ for me when I reached the hospital.

- a) wasn't waiting
- b) weren't waiting
- c) was waiting
- d) were waiting



11. Ann: _____ were dancing in the classroom in the break?

Gary: Pam and I.

- a) What
- b) Where
- c) Which
- d) Who

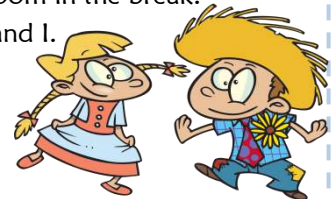

12. Donald _____ sitting quietly in his desk and _____ to his maths teacher carefully.

- a) was / speaking
- b) were / speaking
- c) was / listening
- d) were / listening



13. People _____ at the young couple when they entered the ballroom.

- a) were looking
- b) was looking
- c) were watching
- d) was watching



14. Matthew lost the race because the others _____ faster than him.

- a) was running
- b) wasn't running
- c) were running
- d) weren't running



15. My sister _____ with her friends when I came. She was planting a flower.

- a) was playing
- b) wasn't playing
- c) were playing
- d) weren't playing



16. Mr. Collins _____ when he saw a huge brown bear behind the bushes.

- a) were hike
- b) were hiking
- c) was hike
- d) was hiking



17. People _____ waiting for the manager for the meeting when he called to cancel it.

- a) was
- b) wasn't
- c) were
- d) weren't



18. Joe: _____ were you doing when I telephoned you?

Sara: I was reading a novel.

- a) Where
- b) What
- c) Who
- d) Which



19. Mr. Lewis _____ only salad at dinner yesterday evening because he went on a strict diet.

- a) was eating
- b) wasn't eating
- c) were eating
- d) weren't eating



20. Amy: _____ Rose _____ rope with her friends an hour ago?

Bill: Yes, she was.

- a) Was / skip
- b) Was / skipping
- c) Were / skip
- d) Were / skipping



ANSWER KEY

- 1) c
- 2) a
- 3) d
- 4) c
- 5) b
- 6) a
- 7) a
- 8) d
- 9) b
- 10) d
- 11) d
- 12) c
- 13) a
- 14) c
- 15) b
- 16) d
- 17) c
- 18) b
- 19) a
- 20) b

PAST CONTINUOUS - SPEAKING



Susan



James



Robert and Linda



Thomas



Patricia and David



Mr. Green



Mrs. Evans



Mary



Mr. and Mrs. Hill



Judy



The musicians



Freddie



Sam



Betty



Joe and his mum



Sara and Billy



Mr. Carter



Albert



Logan



Marilyn



Mr. and Mrs. Lee



a robber



Uncle Sam



Mr. and Mrs. Smith



The candidate

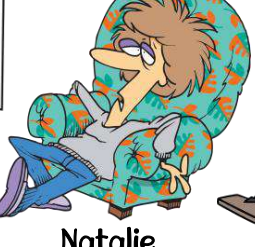

Natalie



Theresa

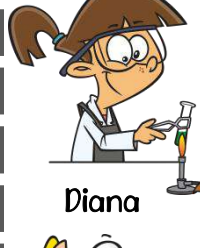

Diana

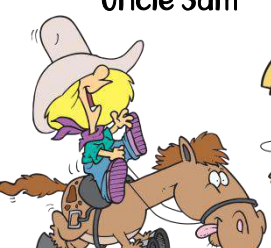

Doris



Kayla

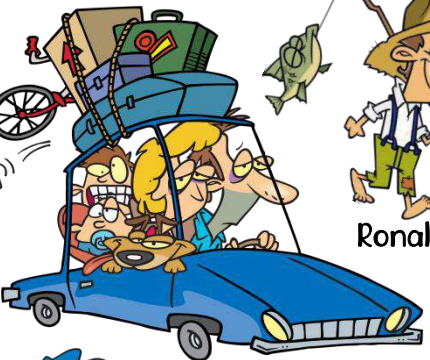

The Harrisons



Ronaldo



Brittany and Louis



Gabriel



Carol



Lawrence

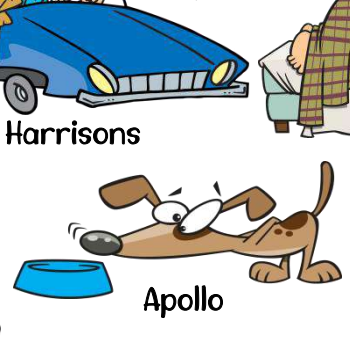

Apollo



Arthur

Sean



Ann



Mrs. Will



Tom

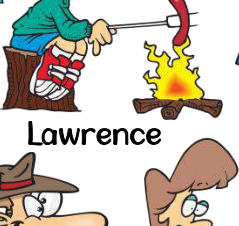

Austin



Four women



Three men



Noah



Pam



Austin

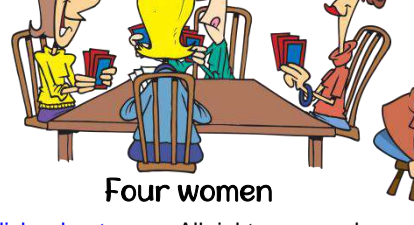

Four women



Ethan and Walter

WHAT WERE THEY DOING?

Look at the pictures and write what these people were doing at 4 p.m. yesterday

- play with father
- drive a funny car
- read a cookbook
- play baseball
- type a short story
- tour the city
- cook the dinner
- hunt in the woods
- draw a picture
- ride a donkey
- read a newspaper
- rent a house
- eat Mexican food
- brush teeth
- take the trash out
- lift weights
- work on the farm
- water the plants
- sing on old song
- teach maths
- play the recorder
- dance happily
- make a potion
- talk in the office
- play the recorder
- have an exam
- work in the lab

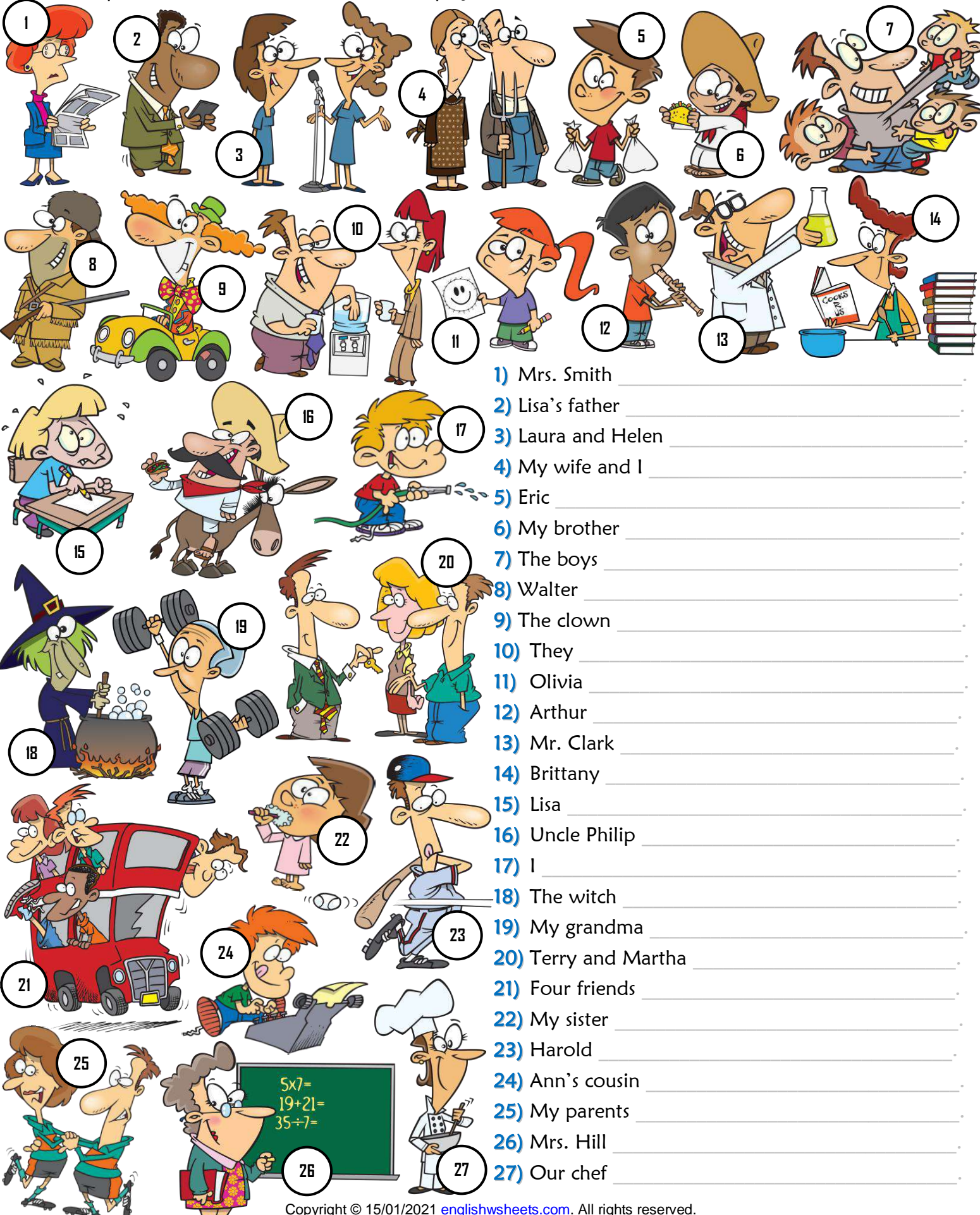

- 1) Mrs. Smith _____
- 2) Lisa's father _____
- 3) Laura and Helen _____
- 4) My wife and I _____
- 5) Eric _____
- 6) My brother _____
- 7) The boys _____
- 8) Walter _____
- 9) The clown _____
- 10) They _____
- 11) Olivia _____
- 12) Arthur _____
- 13) Mr. Clark _____
- 14) Brittany _____
- 15) Lisa _____
- 16) Uncle Philip _____
- 17) I _____
- 18) The witch _____
- 19) My grandma _____
- 20) Terry and Martha _____
- 21) Four friends _____
- 22) My sister _____
- 23) Harold _____
- 24) Ann's cousin _____
- 25) My parents _____
- 26) Mrs. Hill _____
- 27) Our chef _____

ANSWER KEY

- 1) Mrs. Smith was reading a newspaper.
- 2) Lisa's father was texting a friend.
- 3) Laura and Helen were singing an old song.
- 4) My wife and I were working on the farm.
- 5) Eric was taking the trash out.
- 6) My brother was eating Mexican food.
- 7) The boys were playing with their father.
- 8) Walter was hunting in the woods.
- 9) The clown was driving a funny car.
- 10) They were talking in the office.
- 11) Olivia was drawing a picture.
- 12) Arthur was playing the recorder.
- 13) Mr. Clark was working in the lab.
- 14) Brittany was reading a cookbook.
- 15) Lisa was having an exam.
- 16) Uncle Philip was riding a donkey.
- 17) I was watering the plants.
- 18) The witch was making a potion.
- 19) My grandma was lifting weights.
- 20) Terry and Martha were renting a house.
- 21) Four friends were touring the city.
- 22) My sister was brushing her teeth.
- 23) Harold was playing baseball.
- 24) Ann's cousin was typing a short story.
- 25) My parents were dancing happily.
- 26) Mrs. Hill was teaching maths.
- 27) Our chef was cooking the dinner.

PAST CONTINUOUS TENSE - WORD ORDER

Put the words in correct order and make positive sentences, negative sentences or questions.















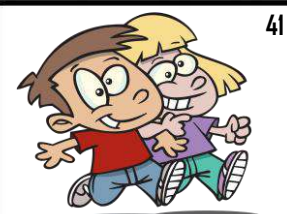







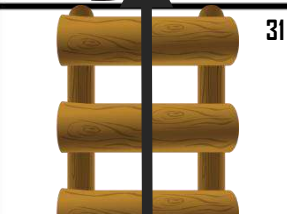

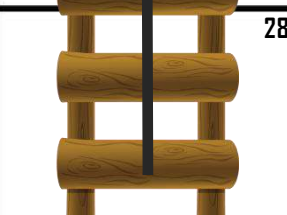



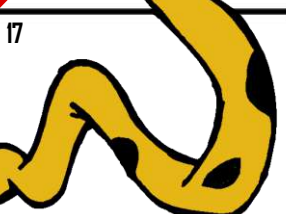

1. Thomas Edison - 9 p.m. - watching - I - about - yesterday - was - a documentary _____
_____.
2. came - were - the teacher - my classmates - on a project - when - working _____
_____.
3. at noon - restaurant - Heather and Diane - lunch - at the - eating - Chinese - were _____
_____?
4. were - at 7 a.m. - your brother - this morning - where - going - and - you _____
_____?
5. snowing - Ralph - it - started - was - when - on his boat - fishing _____
_____.
6. the police - robbing - when - with masks - came two men - the bank - were _____
_____?
7. woke up - was - last night - baby sister - when - crying - my - I _____
_____.
8. Patrick and Rachel - arrived - the balcony - were - their - cleaning - father - when _____
_____.
9. the drums - who - playing - at 10 a.m. - were - last Saturday _____
_____.
10. delivering - attacked - was - the postman - the parcels - two dogs - when - him _____
_____.
11. anything - Charlotte - weren't - yesterday - we - phoned - doing - when - us _____
_____.
12. this morning - red roses - Mrs. Wright - in front of - selling - beautiful - was - the cafe _____
_____.
13. her room - the novel - she - into her room - her mum - wasn't - came - reading - when _____
_____.
14. last Saturday - was - a friend - Mr. Young - had - when - an accident - texting - he _____
_____?
15. her friends - monkey bars - Karen - on the - an hour ago - playing - were - and _____
_____.

16. having - phoned - your parents - where - and - I - you - yesterday - dinner - were - when _____
_____?
17. this morning - Adam and Peter - in the garden - were - a hole - why - digging _____
_____?
18. riding - whose - last Monday - you - when - saw - motorbike - you - I - were _____
_____?
19. a barbeque - happened - having - were - when - Bradley and Louis - the earthquake _____
_____.
20. was - at the beach - shouting - two hours ago - a woman - arrived - "Help!" - we - when _____
_____.
21. repairing - hurt - my grandpa - the roof - when - fell down - was - and - he - his neck _____
_____.
22. when - some popcorn - came - making - was - I - my friends - finally _____
_____.
23. one of - was - past - Isabella - shoe heels - when - walking - the bakery - her - broke _____
_____.
24. a group of - were - Australia - they - over - saw - migratory birds - flying - when - they _____
_____.
25. weren't - freezing - was - we - because - playing - the weather - outside _____
_____.
26. in the - went out - my parents - waiting for - me - school garden - I - were - when _____
_____.
27. an expensive - arrived - the mechanic - we - was - sports car - repairing - when _____
_____.

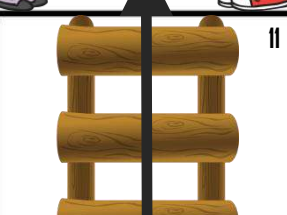
ANSWER KEY

1. I was watching a documentary about Thomas Edison at 9 p.m. yesterday.
2. My classmates were working on a project when the teacher came.
3. Were Heather and Diane eating lunch at the Chinese restaurant at noon?
4. Where were you and your brother going at 7 a.m. this morning?
5. Ralph was fishing on his boat when it started snowing.
6. Two men with masks were robbing the bank when the police came.
7. My baby sister was crying when I woke up last night.
8. Patrick and Rachel were cleaning the balcony when their father arrived.
9. Who were playing the drums at 10 a.m. last Saturday?
10. The postman was delivering the parcels when two dogs attacked him.
11. We weren't doing anything when Charlotte telephoned us yesterday.
12. Was Mrs. Wright selling beautiful red roses in front of the cafe this morning?
13. She wasn't reading the novel when her mum came into her room.
14. Was Mr. Young texting a friend when he had an accident last Saturday?
15. Karen and her friends were playing on the monkey bars an hour ago.
16. Where were you and your parents having dinner when I phoned yesterday?
17. Why were Adam and Peter digging a hole in the garden this morning?
18. Whose motorbike were you riding when I saw you last Monday?
19. Bradley and Louis were having a barbeque when the earthquake happened.
20. A woman was shouting "Help" when we arrived at the beach two hours ago.
21. My grandpa was repairing the roof when he fell down and hurt his neck.
22. I was making some popcorn when my friends finally came.
23. Isabella was walking past the bakery when one of her shoe heels broke.
24. They were flying over Australia when they saw a group of migratory birds.
25. We weren't playing outside because the weather was freezing.
26. My parents were waiting for me in the school garden when I went out.
27. The mechanic was repairing an expensive sports car when we arrived.

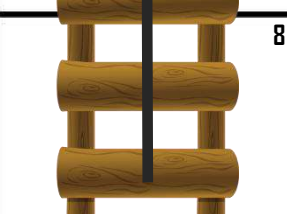
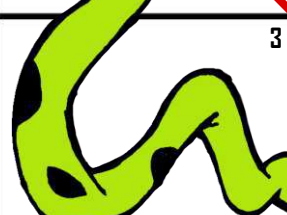
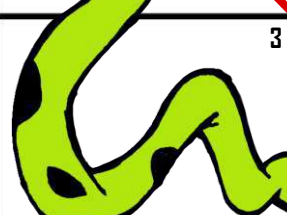
PAST CONTINUOUS TENSE - BOARD GAME

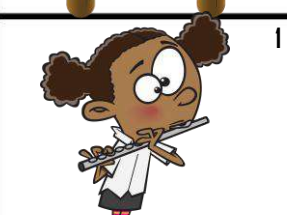
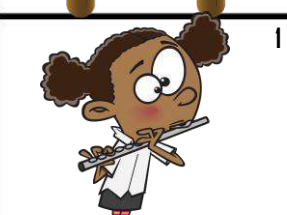
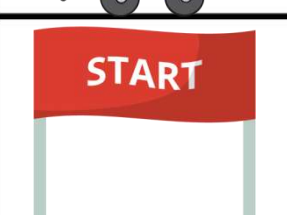
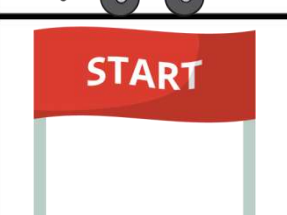
43 	42 	41 	40 
35 	36 	37 	38 
34 	33 	32 	31 
25 	26 	27 	28 
24 	23 	22 	21 
15 	16 	17 	20 
14 	13 	12 	19 
5 	6 	7 	11 
4 	3 	2 	8 
		1 	9 
			START 

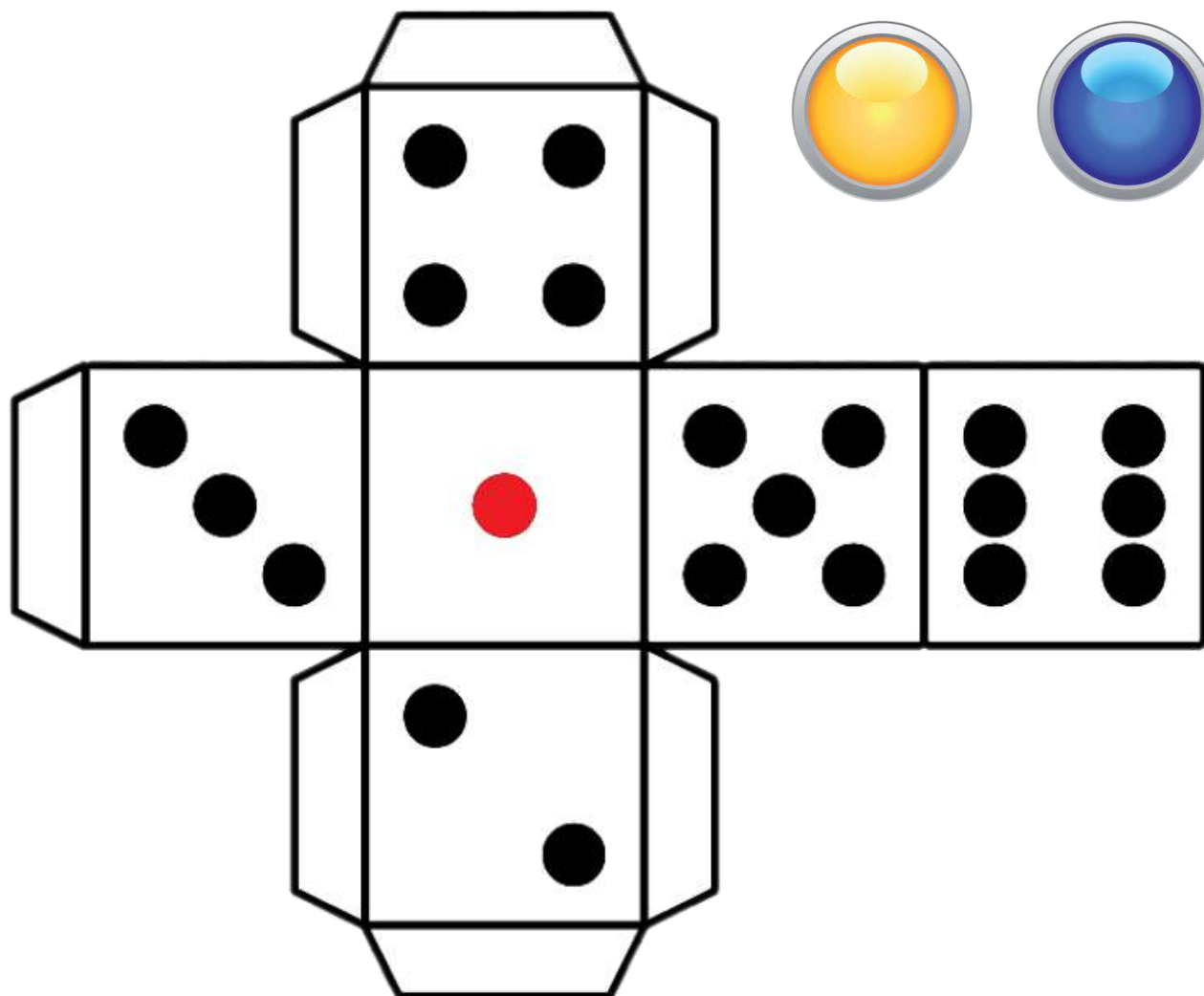
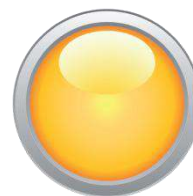
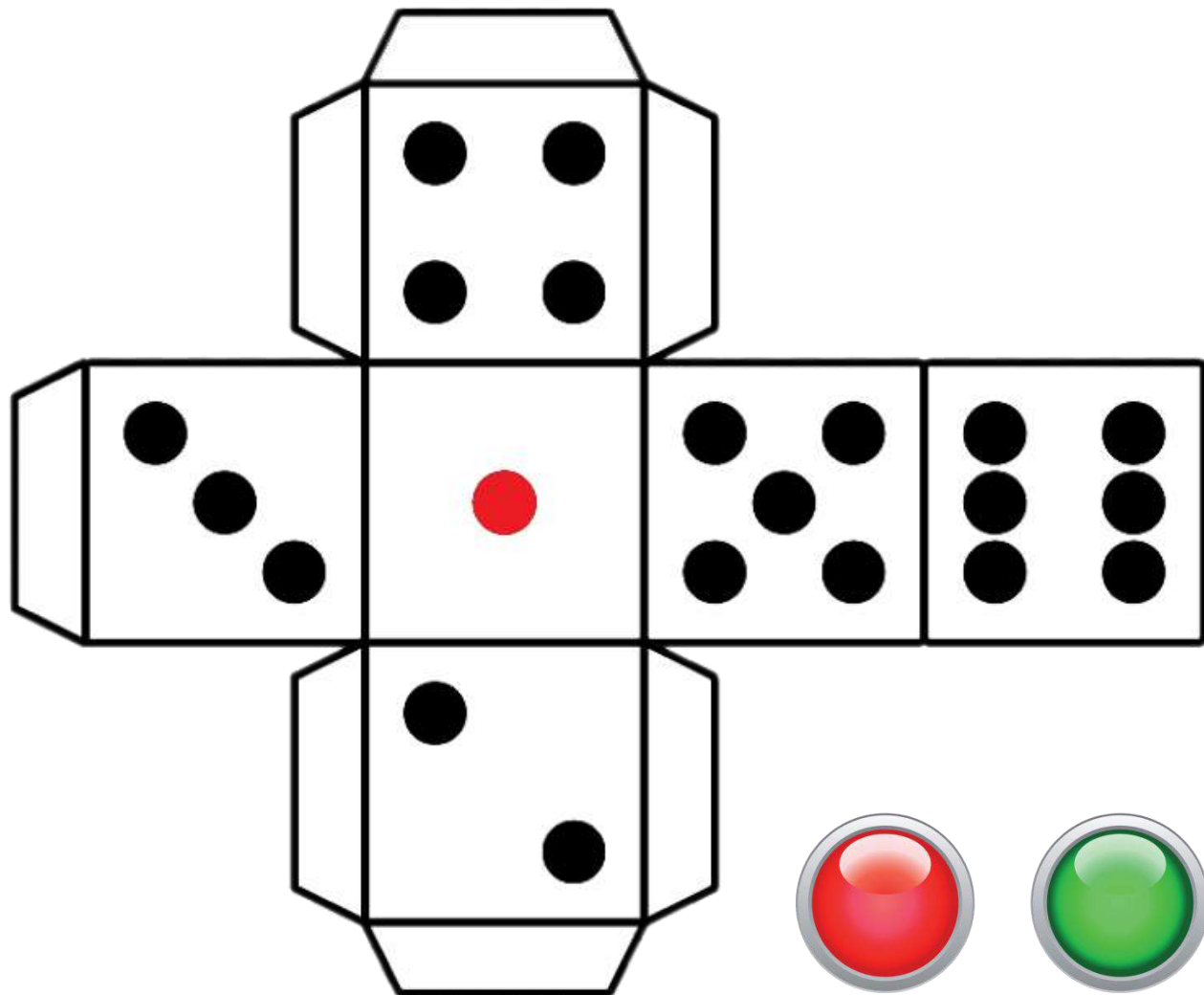

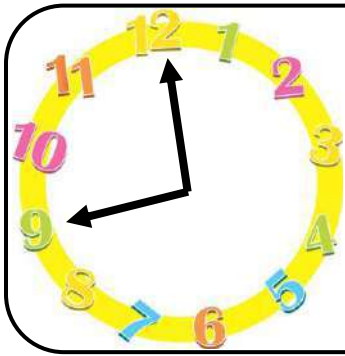

AT 9 O'CLOCK YESTERDAY MORNING

Fill in the blanks with the correct forms of the verbs in brackets. Use "Past Continuous Tense"

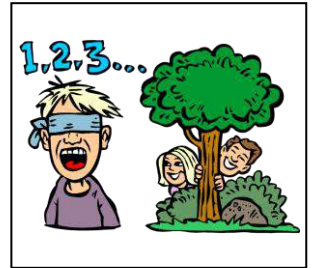

Mr. Thompson
_____ (drive) to work in his new car.

The chef
_____ (cook) the soup of the day in his kitchen.

Peter, Jeremy and Rachel
_____ (wait) for the school bus.

Brian
_____ (play) his new car racing game on his computer.

The children
_____ (play) hide and seek in the playground.

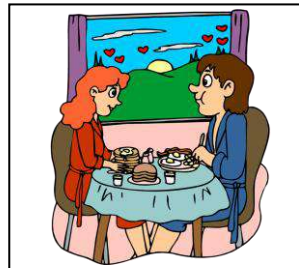
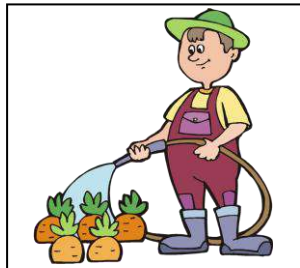

Laura and her mother
_____ (eat) strawberry ice-cream.

Mr. Chapman
_____ (water) the carrots in his garden.

Joseph _____ (ride) a camel. He _____ (take) some photographs.

My mother and father
_____ (have) breakfast by the window.

Susanna
_____ (practise) the lyre and _____ (sing) an old song.



Sandra and Marilyn
_____ (clean) the living room together.

Max _____ (plant) an orange tree in the school garden.

Steven and Pamela
_____ (listen) to the new song of their favourite singer.

Freddie
_____ (walk) his dog in the city center.

Clara
_____ (watch) a documentary about wild animals

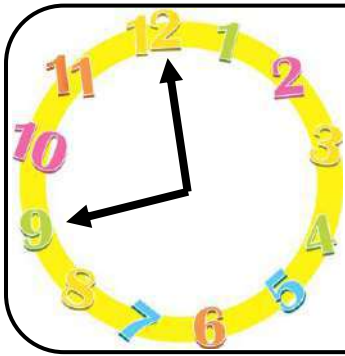

AT 9 O'CLOCK YESTERDAY MORNING ANSWER KEY

Fill in the blanks with the correct forms of the verbs in brackets. Use "Past Continuous Tense"



Mr. Thompson **was driving** to work in his new car.



The chef **was cooking** the soup of the day in his kitchen.



Peter, Jeremy and Rachel **were waiting** for the school bus.



Brian **was playing** his new car racing game on his computer.



The children **were playing** hide and seek in the playground.



Laura and her mother **were eating** strawberry ice-cream.



Mr. Chapman **was watering** the carrots in his garden.



Joseph **was riding** a camel. He **was taking** some photographs.



My mother and father **were having** breakfast by the window.



Susanna **was practising** the lyre and **singing** an old song.



Sandra and Marilyn **were cleaning** the living room together.



Max **was planting** an orange tree in the school garden.



Steven and Pamela **were listening** to the new song of their favourite singer.



Freddie **was walking** his dog in the city center.



Clara **was watching** a documentary about wild animals on TV.

Mary's Saturday

Last Saturday was very nice and busy for Mary. She got up very early in the morning and prepared a nice breakfast for herself. She ate fried eggs, pancakes, honey, butter, jam and drank a full glass of orange juice. After breakfast, she took a shower, brushed her teeth and put on some make-up. She wore her favourite dress and shoes and left home. The weather was sunny and warm so she walked to the shopping mall. She met her best friend, Jane there and they went in and out of the shops together. Mary bought some clothes for herself, a nice watch for her dad and a beautiful scarf for her mum. Jane bought a pair of sandals but she didn't buy any clothes for herself because she thought she didn't need any. After shopping they were both tired and hungry, so they went into a restaurant. They both had beef steak, rice and salad and talked about what to do next. They finally decided to watch a drama at the cinema. Mary bought the tickets and Jane bought some popcorn and fresh orange juice.



The film was very touching so they sometimes hugged each other and wept silently. After the film Mary said goodbye to her friend and visited the bookshop to have a look at the latest novels. She found a crime novel by her favourite author and bought it. Then she realized that it was already 3.30 p.m. and she had to hurry up for her piano course. She took a taxi and met her music teacher just on time. It was 6 p.m. when she finally got home. She immediately put on her pyjamas and watched some TV. Then she went to the kitchen and helped her mum prepare the dinner. Mary made a green salad and set the table while her mum cooked. Soon her father came home and they ate dinner. After dinner Mary gave her mum and dad their presents. They were both happy because her father needed a watch and her mum was amazed by the scarf's colours. They hugged each other tenderly. It was 9 p.m. when Mary brought her chess set from her room. She played well but her father won the game. Then she went to her room and listened to some music and surfed the Net. It was almost 11:00 p.m. when her mother came with a glass of milk in her hand and told her that it was late. She drank the milk and brushed her teeth. She went into her bed and started reading the novel that she bought. It was so absorbing that she could not leave it. She read and read until she fell asleep.

A) Read the text and answer the questions below

1. Did Mary get up early or late last Saturday?
_____.
2. What did she eat for breakfast?
_____.
3. Did she drink a glass of fresh apple juice?
_____.
4. What did she do after breakfast?
_____.
5. Why did she walk to the shopping mall?
_____.
6. Who did she meet at the shopping mall?
_____.
7. What did Mary buy for her mum and dad?
_____.
8. Why didn't Jane buy any clothes for herself?
_____.

9. Were Mary and Jane tired after shopping?
_____.
10. What did they have at the restaurant?
_____.
11. What did they decide to do after lunch?
_____.
12. Why did Mary and Jane weep in the cinema?
_____.
13. What did Mary buy from the bookshop?
_____.
14. How did she go to the piano course?
_____.
15. What time did she finally arrive home?
_____.
16. What did Mary and her father play?
_____.
17. Who brought Mary a glass of milk?
_____.
18. Why couldn't she stop reading the novel?
_____.

ANSWER KEY

A) Read the text and answer the questions below

1. She got up early last Sunday.
2. She ate fried eggs, pancakes, honey, butter and jam for breakfast.
3. No, he didn't.
4. She took a shower, brushed her teeth and put on some make-up.
5. Because the weather was sunny and warm.
6. She met her best friend, Jane at the shopping mall.
7. She bought a nice watch for her dad and a beautiful scarf for her mum.
8. Because she thought she didn't need any clothes.
9. Yes, they were.
10. They had beef steak, rice and salad at the restaurant.
11. They decided to watch a drama after lunch.
12. Because the film was so touching.
13. She bought a crime novel from the bookshop.
14. She went to the piano course by taxi.
15. She finally arrived home at 6 p.m.
16. They played chess.
17. Her mother brought Mary a glass of milk.
18. Because it was so absorbing.

Mary's Saturday

Last Saturday was very nice and busy for Mary. She got up very early in the morning and prepared a nice breakfast for herself. She ate fried eggs, pancakes, honey, butter, jam and drank a full glass of orange juice. After breakfast, she took a shower, brushed her teeth and put on some make-up. She wore her favourite dress and shoes and left home. The weather was sunny and warm so she walked to the shopping mall. She met her best friend, Jane there and they went in and out of the shops together. Mary bought some clothes for herself, a nice watch for her dad and a beautiful scarf for her mum. Jane bought a pair of sandals but she didn't buy any clothes for herself because she thought she didn't need any. After shopping they were both tired and hungry, so they went into a restaurant. They both had beef steak, rice and salad and talked about what to do next. They finally decided to watch a drama at the cinema. Mary bought the tickets and Jane bought some popcorn and fresh orange juice.

The film was very touching so they sometimes hugged each other and wept silently. After the film Mary said goodbye to her friend and visited the bookshop to have a look at the latest novels. She found a crime novel by her favourite author and bought it. Then she realized that it was already 3.30 p.m. and she had to hurry up for her piano course. She took a taxi and met her music teacher just on time. It was 6 p.m. when she finally got home. She immediately put on her pyjamas and watched some TV. Then she went to the kitchen and helped her mum prepare the dinner. Mary made a green salad and set the table while her mum cooked. Soon her father came home and they ate dinner. After dinner Mary gave her mum and dad their presents. They were both happy because her father needed a watch and her mum was amazed by the scarf's colours. They hugged each other tenderly. It was 9 p.m. when Mary brought her chess set from her room. She played well but her father won the game. Then she went to her room and listened to some music and surfed the Net. It was almost 11:00 p.m. when her mother came with a glass of milk in her hand and told her that it was late. She drank the milk and brushed her teeth. She went into her bed and started reading the novel that she bought. It was so absorbing that she could not leave it. She read and read until she fell asleep.



WRITE TRUE OR FALSE

- _____ Mary was tired so she preferred to stay at home last Saturday.
- _____ The weather was fine so she went to the shopping mall on foot.
- _____ Mary bought some clothes for herself but she didn't buy anything for her parents.
- _____ Jane thought she had enough clothes so she didn't buy any.
- _____ Mary and Jane laughed and laughed because the film was so funny.
- _____ Mary visited the bookshop, but she forgot to go to her piano course.
- _____ She bought the latest novel of her favourite writer from the bookshop.
- _____ Mary started reading the novel as soon as she arrived home.
- _____ Her father won the chess game although Mary played well.
- _____ Mary really enjoyed the crime novel.

CIRCLE THE CORRECT CHOICE

- Mary didn't have any for breakfast.
pancakes / sausages / fried eggs
- She put on her favourite before she went out.
dress / necklace / earring
- After some shopping, the two friends went into a because they were hungry.
cinema / cafe / restaurant
- Mary and Jane decided to watch a drama film at
home / the cinema / a bookshop
- Mary bought the and Jane bought some popcorn and fresh orange juice.
tickets / sandals / books
- The film they watched was so
amusing / tiring / sad
- Her mother brought Mary while she was listening to music and surfing the Net.
a cup of tea / a glass of milk / a bottle of water

ANSWER KEY

Write True or False

1. False
2. True
3. False
4. True
5. False
6. False
7. True
8. False
9. True
10. True

Circle the Correct Choice

1. sausages
2. dress
3. restaurant
4. the cinema
5. tickets
6. sad
7. a glass of milk

AT THE CAFE

A) Complete the dialogue with the words below

- | | | |
|-----------|----------|-----------|
| ● enjoyed | ● was | ● were |
| ● swam | ● bought | ● wanted |
| ● flew | ● stayed | ● visited |
| ● went | ● played | ● had |

Pamela: I _____ (1) to stop by you for a cup of coffee last Monday, but nobody opened the door. Where were you, Kelly?

Kelly: Oh, we weren't at home. George and I needed a holiday for some time. We took kids and _____ (2) to Antalya, Turkey for a week.

Pamela: Really? How was it like? Did you have a good time?

Kelly: Yes, it was marvellous. We all felt relaxed and we were all fascinated by Turkey's beauty. The weather was hot and sunny every day.

Pamela: Where did you stay?

Kelly: We _____ (3) at a five-star hotel. It was so luxurious and cheap. It _____ (4) a big swimming pool and a lot of slides. Molly and Brian _____ (5) them a lot. Our room was comfortable and it had a beautiful seaview.

Pamela: How _____ (6) the food? Did you try Turkish cuisine?

Kelly: The food was so delicious. I especially liked kebabs and seafood there. There _____ (7) lots of good restaurants.

Pamela: How did you spend your days?

Kelly: As soon as we had our breakfast in the morning, we usually went to the beach, _____ (8) in the sea and sunbathed. Brian and Molly tried windsurfing and they _____ (9) beach volleyball. In the afternoons we _____ (10) historic places and learned much about ancient civilisations.

Pamela: Did you do any shopping?

Kelly: Yes, of course. On Wednesday afternoon we visited the shops and _____ (11) some souvenirs for our relatives and friends. George and Brian bought lots of t-shirts and jeans for themselves. Molly and I bought some handbags and dresses.

Pamela: When did you come back home?

Kelly: We _____ (12) back home on Friday evening.



B) Read the dialogue and write TRUE or FALSE

1. George and Kelly didn't take kids to Turkey. (_____)
2. They all enjoyed their holiday in Turkey. (_____)
3. They could see the sea from their window. (_____)
4. Brian tried windsurfing, but Molly didn't. (_____)
5. They did some shopping on Wednesday. (_____)

C) Answer the questions about your daily routines

1. Where did Kelly and George go for holiday?
_____.
2. Did Kelly and her family enjoy their holiday?
_____.
3. What was the weather like in Antalya?
_____.
4. What did they usually do after breakfast?
_____.
5. Which food did Kelly especially like in Turkey?
_____.
6. What did they do in the afternoons?
_____.
7. Who did they buy the souvenirs for?
_____.
8. What did Molly and Kelly buy for themselves?
_____.

ANSWER KEY

A) Complete the dialogue with the words below

1. wanted
2. went
3. stayed
4. had
5. enjoyed
6. was
7. were
8. swam
9. played
10. visited
11. bought
12. flew

B) Read the dialogue and write TRUE or FALSE

1. False
2. True
3. True
4. False
5. True

C) Answer the questions about your daily routines

1. They went to Antalya, Turkey for holiday.
2. Yes, they did.
3. It was hot and sunny every day.
4. They usually went to the beach, swam in the sea and sunbathed.
5. She especially liked kebabs and seafood in Turkey.
6. They visited historic places in the afternoons.
7. They bought the souvenirs for their relatives and friends.
8. They bought some handbags and dresses for themselves.

PAST SIMPLE

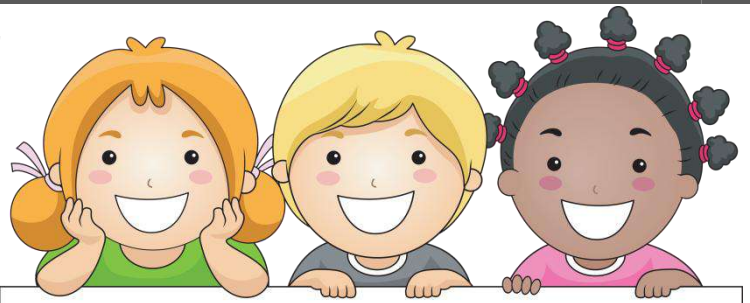

Fill in the blanks with the correct forms of the verbs in brackets to complete the sentences

- The children _____ (play) football for two hours yesterday afternoon.
- Mr. Ramirez _____ (buy) a bigger car last month because he _____ (have) twins.
- Anthony and Deborah _____ (go) to the library to find some information for their homework.
- We _____ (not have) any eggs and sugar, so I couldn't make the cake.
- Emma and Ruth _____ (find) a wallet on the street and _____ (take) it to the police station.
- The teacher _____ (be) angry with Sean because he _____ (not do) his homework.
- Mrs. Garcia _____ (eat) beef steak and _____ (drink) coke at the restaurant last Wednesday afternoon.
- Last summer my sister and I _____ (swim) in the lake and _____ (feed) the ducks.
- My uncle _____ (pick) all the apples on his trees and he _____ (sell) them at the market.
- I _____ (not know) his home address, so I _____ (phone) and _____ (ask) his wife.
- Did your grandmother _____ (move) to a small village near London last March?
- Who _____ (discover) America in 1492?
- Abigail _____ (brush) her teeth before she _____ (read) a novel by Agatha Christie and _____ (sleep).
- The detective _____ (question) the thief, but he _____ (not talk) to the owner of the house last night.
- There _____ (not be) a lot of cars in the rush hour yesterday evening, so I _____ (come) home early.
- The weather _____ (be) rainy yesterday morning, so Mrs. Sanchez _____ (drive) to work instead of walking.
- My father _____ (build) a tree house for me and my sister, Gloria last spring.
- They _____ (not buy) the laptop from the mall as they _____ (not have) enough money for it.
- Mr. Davis _____ (leave) home earlier this morning because there _____ (be) a serious problem at the factory.
- Some of the students in our class _____ (join) the chess club this week.
- Billy _____ (run) in the living room and _____ (break) the vase two days ago.
- Megan _____ (not feel) well yesterday morning, so she _____ (not go) to school.
- The fishermen _____ (catch) a big tuna and _____ (take) it to the fish market in Canterbury.
- The Browns _____ (sit) on their sofa and _____ (watch) a comedy film last night.
- The teacher _____ (ask) a very difficult question to her students this morning.
- The police _____ (arrest) him because he _____ (steal) a valuable ring from the jewellery shop.
- I _____ (not try) the yellow dress on me because _____ (not like) it at all.
- Did your grandpa _____ (finish) painting all the fences?
- Who _____ (tell) you about the rock concert next Saturday?
- Theresa _____ (dive) deep into the water and _____ (see) a huge caretta caretta turtle yesterday morning.
- We _____ (stay) at a five-star hotel last June, but we _____ (not like) the room.
- How did the kids _____ (go) to school?
- Alice _____ (wash) all the dishes and _____ (clean) the bathroom, but Madison _____ (not do) anything.
- My aunt and I _____ (go) to the new shopping mall and _____ (spend) all our money on clothing.
- She _____ (wear) a beautiful dress and a necklace to the party last night.
- Messi _____ (fall) on the ground and _____ (hurt) his leg in the last match.
- Mr. Thompson and his wife _____ (plant) an olive tree and _____ (water) it.

ANSWER KEY

1. played
2. bought / had
3. went
4. didn't have
5. found / took
6. was / didn't do
7. ate / drank
8. swam / fed
9. picked / sold
10. didn't know / phoned / asked
11. move
12. discovered
13. brushed / read / slept
14. questioned / didn't talk
15. weren't / came
16. was /drove
17. built
18. didn't buy / didn't have
19. left / was
20. joined
21. ran / broke
22. didn't feel / didn't go
23. caught / took
24. sat / watched
25. asked
26. arrested / stole
27. didn't try / didn't like
28. finish
29. told
30. dived / saw
31. stayed / didn't like
32. go
33. washed / cleaned / didn't do
34. went / spent
35. wore
36. fell / hurt
37. planted / watered

WAS/WERE

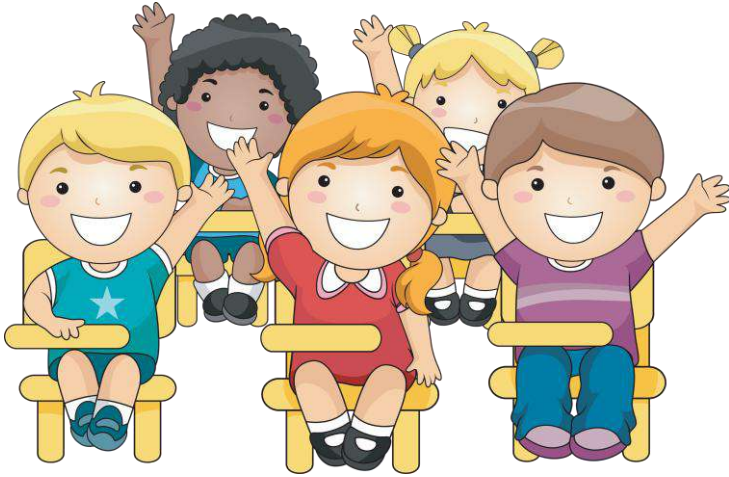

A) Fill in the blanks with **was** or **were**

1. I _____ at school at 8 o'clock yesterday.
2. My mother _____ a nurse ten years ago.
3. _____ Linda and Karen friends last year?
4. Mr. Perez _____ at the hospital last weekend.
5. The kids _____ hot and thirsty after the match.
6. Her parents _____ on holiday in Hawaii.
7. Nikola Tesla _____ a great inventor.
8. _____ Mrs. Clark in her garden this morning?
9. They _____ at the tennis court two hours ago.
10. My mother and I _____ bored yesterday.
11. Who _____ the girl at the party last night?
12. There _____ lots of cars on the street today.
13. _____ there any milk in the fridge yesterday?
14. He _____ only twelve years old last year.
15. Amy _____ hungry and thirsty after work.

B) Answer the questions about yourself.

1. Where were you at 9 p.m. yesterday evening?
_____ .
2. Where and when were you born?
_____ .
3. Were you a student three years ago?
_____ .
4. What was your first teacher's name?
_____ .
5. What was the weather like yesterday morning?
_____ .

C) Fill in the blanks with **was**, **wasn't**, **were**, **weren't**

1. A: How _____ your school trip last weekend?
B: It _____ fantastic.
2. A: _____ your parents at the theatre at eight o'clock yesterday evening?
B: No, they _____ .
3. A: What _____ the weather like in London last winter?
B: It _____ cold and snowy.
4. A: Where _____ Beverly and Amber at half past four after school?
B: They _____ at the library.
5. A: Who _____ with you in the school garden?
B: Philip _____ with me.
6. A: _____ there a lot of people at the shopping mall this afternoon?
B: No, there _____ .
7. A: The Millers _____ at home last night. Where _____ they?
B: They _____ at the hospital. Rose _____ ill.

D) Read the answers and write questions to the **underlined** words.

1. _____ ?
The football match was at 7 o'clock.
2. _____ ?
I was with my parents at the picnic last Sunday.
3. _____ ?
Isaac Newton was born on 25 December 1642.
4. _____ ?
Yes, Thomas Edison was a great inventor.
5. _____ ?
Elvis Presley was a famous American singer.
6. _____ ?
Harold was at the zoo yesterday afternoon.
7. _____ ?
No, I wasn't with Janice at the park yesterday.
8. _____ ?
Mr. and Mrs. Lee were in London last winter.
9. _____ ?
The kids were in their beds at 7 o'clock today.
10. _____ ?
The ceremony was at about 4 p.m. last Friday.

ANSWER KEY

A) Fill in the blanks with **was** or **were**

- | | | |
|---------|----------|----------|
| 1. was | 6. were | 11. was |
| 2. was | 7. was | 12. were |
| 3. were | 8. was | 13. was |
| 4. was | 9. were | 14. was |
| 5. were | 10. were | 15. was |

B) Answer the questions about yourself.

Your own answers

C) Fill in the blanks with **was, wasn't, were, weren't**

- | | |
|-------------------|--------------------------------|
| 1. was / was | 5. was / was |
| 2. were / weren't | 6. were / weren't |
| 3. was / was | 7. weren't / were / were / was |
| 4. were / were | |

D) Read the answers and write questions to the **underlined** words.

1. What time was the football match?
2. Who were you with at the picnic last Sunday.
3. When was Isaac Newton born?
4. Was Thomas Edison a great inventor?
5. Who was a famous American singer?
6. Where was Harold yesterday afternoon?
7. Were you with Janice at the park yesterday?
8. When were Mr. and Mrs. Lee in London?
9. Where were the kids at 7 o'clock today?
10. What time was the ceremony last Friday?

PAST SIMPLE-REGULAR VERBS

A) Write the **past** forms of the regular verbs below.

- | | | | |
|----------|-------|------------|-------|
| 1. play | _____ | 13. carry | _____ |
| 2. study | _____ | 14. walk | _____ |
| 3. wash | _____ | 15. skip | _____ |
| 4. die | _____ | 16. answer | _____ |
| 5. paint | _____ | 17. enjoy | _____ |
| 6. watch | _____ | 18. cry | _____ |
| 7. try | _____ | 19. laugh | _____ |
| 8. start | _____ | 20. invite | _____ |
| 9. phone | _____ | 21. visit | _____ |
| 10. stay | _____ | 22. move | _____ |
| 11. love | _____ | 23. tidy | _____ |
| 12. help | _____ | 24. like | _____ |



B) Rewrite these sentences making them **positive**.

- Robert didn't wait for his friends this morning.
_____.
- They didn't listen to music at 11 p.m. last night.
_____.
- My mother didn't clean the kitchen yesterday.
_____.
- The students didn't learn Japanese last year.
_____.
- Mr. Smith didn't arrive home before dinner.
_____.
- Her aunt didn't cook the dinner on Tuesday.
_____.

C) Rewrite these sentences making them **negative**.

- Patricia watched a film at 10 p.m. last night.
_____.
- I borrowed a book from the library last week.
_____.
- My classmates answered all the questions.
_____.
- She talked to her English teacher five days ago.
_____.
- Mrs. Jackson repaired the chair last weekend.
_____.
- Eric brushed his teeth before breakfast today.
_____.
- Debra and Rachel cycled to school yesterday.
_____.

D) Answer the questions about yourself.

- Did you play any musical instruments yesterday?
_____.
- Which film did you watch last weekend?
_____.
- Did your mother clean the house last week?
_____.
- Where did you stay on your last holiday?
_____.
- Who did you last talk with on the telephone?
_____.

E) Read the answers and write questions to the **underlined** words.

- _____?
Marilyn printed her photographs last Saturday.
- _____?
Roy worked in a marble factory last year.
- _____?
Mr. King watched the news yesterday evening.
- _____?
My cousin milked all the cows this morning.
- _____?
Yes, she finished her project about recycling.
- _____?
The children visited the library every day.
- _____?
I telephoned Mrs. Garcia at 6 p.m. yesterday.
- _____?
No, Danielle didn't need any help this morning.
- _____?
Roy and Joe jumped on the sofa an hour ago.
- _____?
Mr. Wright played hide and seek with his son.

ANSWER KEY

A) Write the **past** forms of the regular verbs below.

- | | | |
|------------|--------------|-------------|
| 1. played | 9. phoned | 17. enjoyed |
| 2. studied | 10. stayed | 18. cried |
| 3. washed | 11. loved | 19. laughed |
| 4. died | 12. helped | 20. invited |
| 5. painted | 13. carried | 21. visited |
| 6. watched | 14. walked | 22. moved |
| 7. tried | 15. skipped | 23. tidied |
| 8. started | 16. answered | 24. liked |

B) Rewrite these sentences making them **positive**.

1. Robert waited for his friends this morning.
2. They listened to music at 11 p.m. last night.
3. My mother cleaned the kitchen yesterday
4. The students learned Japanese last year.
5. Mr. Smith arrived home before dinner.
6. Her aunt cooked the dinner on Tuesday

C) Rewrite these sentences making them **negative**.

1. Patricia didn't watch a film at 10 p.m. last night
2. I didn't borrow a book from the library last week.
3. My classmates didn't answer all the questions.
4. She didn't talk to her English teacher five days ago.
5. Mrs. Jackson didn't repair the chair last weekend.
6. Eric didn't brush his teeth before breakfast today.
7. Debra and Rachel didn't cycle to school yesterday.

D) Answer the questions **about yourself**.

Your own answers

E) Read the answers and write questions to the **underlined** words.

1. When did Marilyn print her photographs?
2. Where did Roy work last year?
3. What did Mr. King do yesterday evening?
4. Who milked all the cows this morning?
5. Did she finish her project about recycling?
6. How often did the children visit the library?
7. What time did you telephone Mrs. Garcia yesterday?
8. Did Danielle need any help this morning?
9. What did Roy and Joe do an hour ago?
10. What did Mr. Wright play with his son?

PAST SIMPLE-IRREGULAR VERBS

A) Write the **past** forms of the regular verbs below.

- | | | | |
|-----------|-------|-----------|-------|
| 1. drink | _____ | 13. sleep | _____ |
| 2. swim | _____ | 14. fly | _____ |
| 3. buy | _____ | 15. begin | _____ |
| 4. sell | _____ | 16. speak | _____ |
| 5. read | _____ | 17. cut | _____ |
| 6. write | _____ | 18. be | _____ |
| 7. have | _____ | 19. sing | _____ |
| 8. take | _____ | 20. break | _____ |
| 9. leave | _____ | 21. hit | _____ |
| 10. ride | _____ | 22. come | _____ |
| 11. drive | _____ | 23. go | _____ |
| 12. eat | _____ | 24. see | _____ |



B) Rewrite these sentences making them **positive**.

- Betty didn't leave home at 7 a.m. this morning.
_____.
- The children didn't fly their kites two days ago.
_____.
- My father didn't come home before dinner.
_____.
- Mr. Miller didn't teach Italian five years ago.
_____.
- Joshua didn't drink milk at breakfast yesterday.
_____.
- His sister didn't drive to work last Wednesday.
_____.

C) Rewrite these sentences making them **negative**.

- Frank and Anna rode their bicycles in the park.
_____.
- The singer sang my favourite song last weekend.
_____.
- I spoke French when I was in Paris last autumn.
_____.
- My cousin, Alan did his homework after school.
_____.
- Mrs. Wilson fed those street cats this morning.
_____.
- Her parents ate dinner at a Chinese restaurant.
_____.
- The fishermen caught a lot of fish last Sunday.
_____.

D) Answer the questions **about yourself**.

- What did you eat at breakfast this morning?
_____.
- Where did you last go for holiday?
_____.
- Which film did you last see at the cinema?
_____.
- Did you buy any clothes for yourself last week?
_____.
- Who did you last speak with on the telephone?
_____.

E) Read the answers and write questions to the **underlined** words.

- _____?
Vincent drew this nice picture last Sunday.
- _____?
Bobby spent \$50 at the toy shop yesterday.
- _____?
Mr. Lee wrote a novel in July last summer.
- _____?
My uncle built that big barn for the cows.
- _____?
Yes, she brought her project to the teacher.
- _____?
Joyse and Jordan ran by the lake every day.
- _____?
I fed the dogs at 8 a.m. yesterday morning.
- _____?
No, Aaron didn't sell his house three years ago.
- _____?
My parents met their colleagues last weekend.
- _____?
Mrs. Martin ate fried chicken at lunch today.

ANSWER KEY

A) Write the **past** forms of the regular verbs below.

- | | | |
|-----------|-----------|--------------|
| 1. drank | 9. left | 17. cut |
| 2. swam | 10. rode | 18. was/were |
| 3. bought | 11. drove | 19. sang |
| 4. sold | 12. ate | 20. broke |
| 5. read | 13. slept | 21. hit |
| 6. wrote | 14. flew | 22. came |
| 7. had | 15. began | 23. went |
| 8. took | 16. spoke | 24. saw |

B) Rewrite these sentences making them **positive**.

1. Betty left home at 7 a.m. this morning.
2. The children flew their kites two days ago.
3. My father came home before dinner.
4. Mr. Miller taught Italian five years ago.
5. Joshua drank milk at breakfast yesterday.
6. Her sister drove to work last Wednesday.

C) Rewrite these sentences making them **negative**.

1. Frank and Anna didn't ride their bicycles in the park.
2. The singer didn't sing my favourite song last weekend.
3. I didn't speak French when I was in Paris last autumn.
4. My cousin, Alan didn't do his homework after school.
5. Mrs. Wilson didn't feed those street cats this morning.
6. Her parents didn't eat dinner at a Chinese restaurant.
7. The fishermen didn't catch a lot of fish last Sunday.

D) Answer the questions **about yourself**.

Your own answers

E) Read the answers and write questions to the **underlined** words.

1. When did Vincent draw this nice picture?
2. How much did Bobby spend at the toy shop yesterday?
3. What did Mr. Lee write in July last summer?
4. Who built that big barn for the cows?
5. Did she bring her project to the teacher?
6. How often did Joyse and Jordan run by the lake?
7. What time did you feed the dogs yesterday morning?
8. Did Aaron sell his house three years ago?
9. What did your parents do last weekend?
10. What did Mr. Martin eat at lunch today?

PAST SIMPLE-MULTIPLE CHOICE QUESTIONS

CHOOSE THE CORRECT OPTION

1. Lisa gave her father a nice present on his birthday _____.
- a) two days later
 - b) next Monday
 - c) every week
 - d) last Tuesday



2. Donald _____ a red car from a friend last month.
- a) sold
 - b) bought
 - c) told
 - d) thought



3. I _____ in the science lab when I _____ the tube.
- a) was / dropped
 - b) were / dropped
 - c) was / drop
 - d) were / drop



4. Mrs. Hall _____ some pills last night because she _____ ill.
- a) take / were
 - b) took / were
 - c) take / was
 - d) took / was



5. Ella: How _____ you _____ go to school yesterday?
Mike: On foot.
- a) did / went
 - b) were / went
 - c) did / go
 - d) were / go



6. Alfie _____ sad yesterday morning because his friends _____ with him.
- a) was / were
 - b) was / weren't
 - c) were / was
 - d) were / wasn't

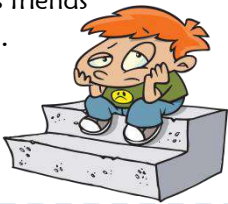

7. Where _____ Frankie _____ for jogging last weekend?
- a) was / go
 - b) did / go
 - c) was / went
 - d) did / went



8. Mr. Wood _____ buy anything from the mall because he _____ have any money with him.
- a) didn't / didn't
 - b) wasn't / wasn't
 - c) didn't / wasn't
 - d) wasn't / didn't



9. Martha _____ at a party last Friday and she _____ all night.
- a) was / dance
 - b) were / dance
 - c) was / danced
 - d) were / danced



10. Eva: What _____ the matter with Finn last month?
Mia: He _____ the measles.
- a) was / had
 - b) were / had
 - c) was / have
 - d) were / have

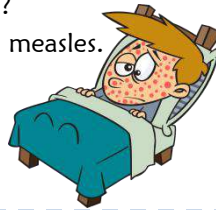

11. Ada: _____ did your mother _____ two years ago?
Iris: At a call center.
- a) Where / work
 - b) Where / worked
 - c) What / work
 - d) What / worked

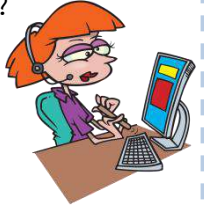

12. Luca: _____ did your uncle _____ for the clothes?
Ruby: 100 dollars.
- a) How many / pay
 - b) How much / paid
 - c) How many / paid
 - d) How much / pay



13. Mr. Cox _____ usually hungry because he _____ have any money to buy food.
- a) was / did
 - b) was / didn't
 - c) were / did
 - d) were / didn't



14. Ralph _____ very fast, but the other runners _____ faster than him.
- a) run / were
 - b) ran / was
 - c) run / was
 - d) ran / were



15. _____ instrument _____ Frederick play for his friends this morning?
- a) Which / was
 - b) Where / did
 - c) Which / did
 - d) Where / was



16. There _____ thousands of soldiers in the battle and they all _____ bravely.
- a) were / fought
 - b) was / fought
 - c) were / fought
 - d) was / fought



17. Jake: _____ did Charlotte _____ her lunch yesterday?
Maya: At the canteen.
- a) What / ate
 - b) Where / ate
 - c) What / eat
 - d) Where / eat



18. Elvis Presley _____ a great singer. He _____ in the USA.
- a) was / live
 - b) were / live
 - c) was / lived
 - d) were / lived



19. Sebastian _____ some of the milk on the table, but he _____ it at all.
- a) didn't drink / liked
 - b) drank / didn't like
 - c) didn't like / drank
 - d) liked / didn't drink



20. Mr. Green _____ awake all night because there _____ mosquitoes everywhere.
- a) were / was
 - b) were / were
 - c) was / were
 - d) was / was



ANSWER KEY

- 1) d
- 2) b
- 3) a
- 4) d
- 5) c
- 6) b
- 7) b
- 8) a
- 9) c
- 10) a
- 11) a
- 12) d
- 13) b
- 14) d
- 15) c
- 16) a
- 17) d
- 18) c
- 19) b
- 20) c

PAST SIMPLE-WORD ORDER

Put the words in correct order and make positive sentences, negative sentences or questions.

1. went - last Saturday - Mr. Flores - late - to bed
_____.
2. to Los Angeles - two days ago - flew - for holiday - My uncle
_____.
3. apply - Did - after school - for the job - your sister -at the Italian restaurant
_____.
4. addition - taught - yesterday - Our maths teacher
_____.
5. melons - you - from the supermarket - How many - buy - did
_____.
6. parasailing - Mark and Paul - last summer - tried
_____.
7. yesterday afternoon - tidied - My elder sister - her room
_____.
8. did - go jogging - Emily and Donna - this morning - Where
_____.
9. in my class - the ceremony - last Monday - All the students - attended
_____.
10. late - he - hurried - was - because - Mr. Harris - for work
_____.
11. did - Who - at the family gathering - see - last Sunday - you
_____.
12. that comedy film - laugh a lot - Did - watched - you - you -when
_____.
13. the Andersons - their lunch - Where - have - did
_____.
14. 11 years old - in Newcastle - Kimberly - when - lived - she was
_____.
15. showed - me - a few weeks ago - Jeffrey - his secret chest
_____.
16. you - What time - yesterday - start - did - doing homework
_____.
17. won - last week - 3-2 - Our football team - the match
_____.



18. too expensive - buy the dress - She - was - because - didn't - it
_____.
19. The police - stole - her - she - because - arrested - a sports car
_____.
20. closed - went - his shop - early - Benjamin - home - and - today
_____.
21. money - last month - earn - did - How much - you
_____.
22. to stay in bed - and - The doctor - told her - Mrs. Lopez - examined
_____.
23. eggplants and tomatoes - last summer - grew - Mr. and Mrs. White
_____.
24. three months ago - his house - to London - sold - her - Our neighbour - moved
_____.
25. the door - I - the doorbell - hear - didn't - didn't - I - because - open
_____.
26. was - but - Ethan - a bit lazy - a smart boy - was - he
_____.
27. left - the door - you - you - last night - lock - home - Did - before
_____.
28. Christian - and - out of the window - a strange man - saw - looked
_____.
29. drank - when - was - woke up - midnight - and - Gloria - and - It - a glass of water
_____.
30. broccoli - he - Willie - was - eating - a little boy - hated - when
_____.

ANSWER KEY

1. Mr. Flores went to bed late last Saturday.
2. My uncle flew to Los Angeles for holiday two days ago.
3. Did your sister apply for the job at the Italian restaurant?
4. Our maths teacher taught addition yesterday.
5. How many melons did you buy from the supermarket?
6. Mark and Paul tried parasailing last summer.
7. My elder sister tidied her room yesterday afternoon.
8. Where did Emily and Donna go jogging this morning?
9. All the students in my class attended the ceremony last Monday.
10. Mr. Harris hurried because he was late for work.
11. Who did you see at the family gathering last Sunday?
12. Did you laugh a lot when you watched that comedy film?
13. Where did the Andersons have their lunch?
14. Kimberly lived in Newcastle when she was 11 years old.
15. Jeffrey showed me his secret chest a few weeks ago.
16. What time did you start doing homework yesterday?
17. Our football team won the match 3-2 last week.
18. She didn't buy the dress because it was too expensive.
19. The police arrested her because she stole a sports car.
20. Benjamin closed his shop and went home early today.
21. How much money did you earn last month?
22. The doctor examined Mrs. Lopez and told her to stay in bed.
23. Mr. and Mrs. White grew eggplants and tomatoes last summer.
24. Our neighbour sold his house and moved to London three months ago.
25. I didn't open the door because I didn't hear the doorbell.
26. Ethan was a smart boy, but he was a bit lazy.
27. Did you lock the door before you left home last night?
28. Christian looked out of the window and saw a strange man.
29. It was midnight when Gloria woke up and drank a glass of water.
30. Willie hated eating broccoli when he was a little boy.

PAST SIMPLE – SPEAKING CARDS

JOSHUA

Yesterday

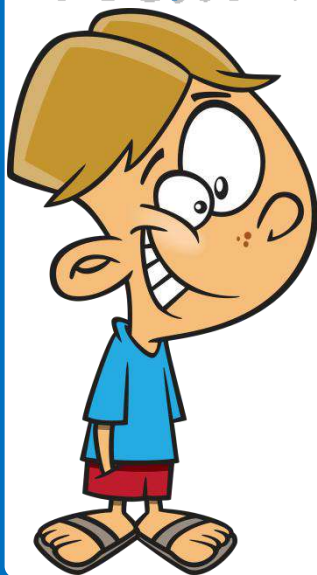

- get up at 7 a.m.
- brush teeth
- take a shower
- have breakfast
- go to school at 8 a.m.
- have lunch at 1 p.m.
- visit the library
- come back home at 4
- play video games
- do English homework
- have dinner at 8 p.m.
- listen to music
- read a short story
- watch an action film
- go to bed at 10:30 p.m.

MRS. LEE

Last Sunday



- wake up at 6:30 a.m.
- prepare breakfast
- water the plants
- leave home at 9 a.m.
- meet her best friend
- go to a cafe and talk
- drink coffee with milk
- do some shopping
- buy a new laptop
- arrive home at 5 p.m.
- take a nap
- feed the cat and dog
- do some exercises
- have a bath
- eat dinner at 7:30 p.m.

REBECCA

Last Friday



- get up at 9 a.m.
- drink orange juice
- eat pancakes and jam
- go nature walking
- take nice photos
- climb a tall tree
- visit the city zoo
- see lions and bears
- have lunch at 13:15 p.m.
- visit grandparents
- help grandma cook
- make a green salad
- have dinner at 7 p.m.
- go back home at 9:00
- print out the photos

EDWARD

Two Days Ago

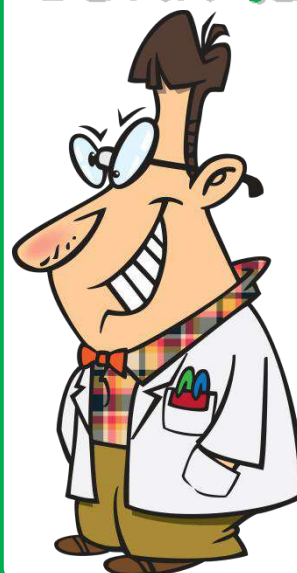

- leave home early
- drive to London
- apply for a job there
- go to the shops
- buy some gifts for wife and kids
- go into a restaurant
- eat fish and chips
- visit British museum
- turn back to Oxford
- arrive home at 7:30
- play games with kids
- watch the news
- eat dinner at 9 p.m.
- tidy up the garage

MR. KING

Last Summer



- book a hotel room
- buy a plane ticket
- fly to Malaga, Spain
- very hot and sunny
- swim in the sea
- try scuba diving
- rent a sports car
- visit historic places
- take a lot of photos
- buy some souvenirs
- learn a little Spanish
- play beach volleyball
- dance at clubs
- eat Spanish food
- do bungee jumping

SANDRA

On Wednesday



- wake up so early
- make a sandwich
- eat it and drink tea
- take her tools
- go out to the garden
- pick some herbs
- plant an olive tree
- rake the leaves
- water the daisies
- feed the street cats
- go into the house
- take a shower
- wear her pink dress
- visit her sister, Pam
- play chess and talk

PAST SIMPLE TENSE - WRITING

yesterday - a very tiring day - wake up at 7 a.m. - go to the bakery - buy bagels and bread - prepare breakfast - start doing housework at 8 a.m. - vacuum and mop the floor - dust the furniture - clean the windows - wash the dishes - do some ironing - take out the trash - do the laundry - cook dinner - go out to the garden - feed the dog - water the flowers and trees - mow the lawn - wash the car - get into the house at 6 p.m. - take a nap for an hour

WHAT A TIRING DAY!













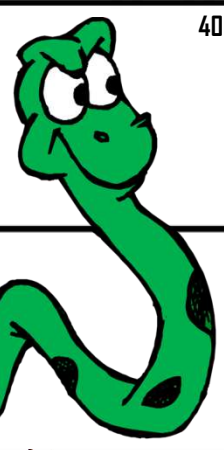
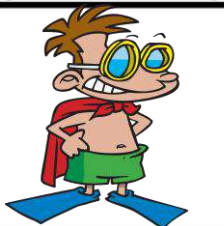
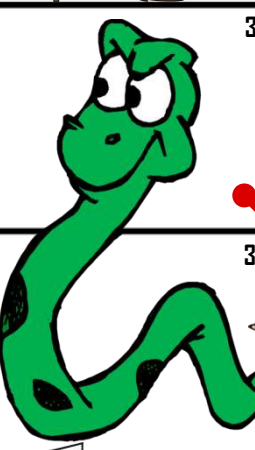

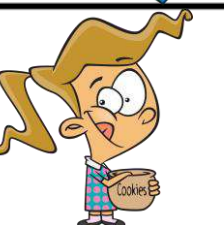

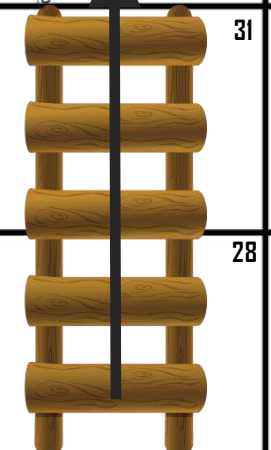

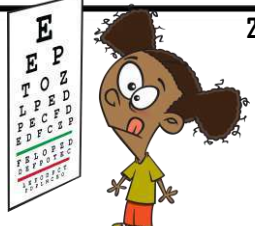

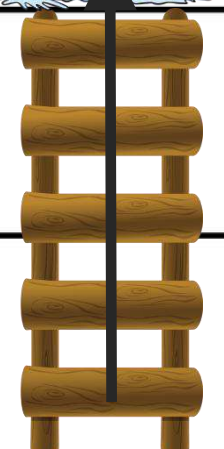
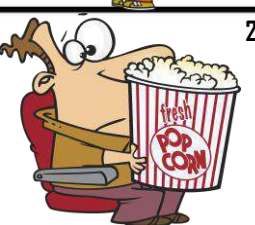
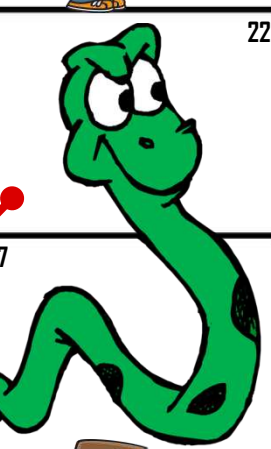
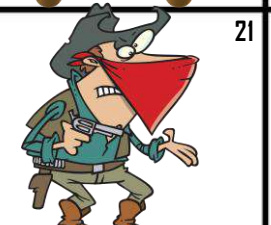
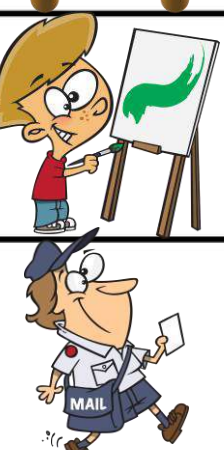
last Saturday - get up at 8 a.m. - eat breakfast with parents - get dressed - go out at 9:15 - meet her friends - sit at a cafe - eat cake and drink coffee - watch a film at the cinema - go to the shops - buy some clothes and shoes - rent bicycles - tour around the town - take photos - say goodbye to friends - go to the art gallery - see some nice paintings - come back home at 4:30 p.m. - play checkers with sister, Megan - listen to music and surf on the Net

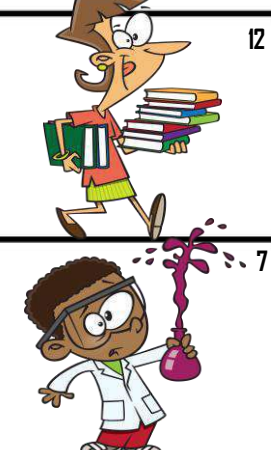
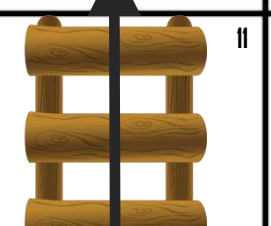
LAST SATURDAY WAS GREAT

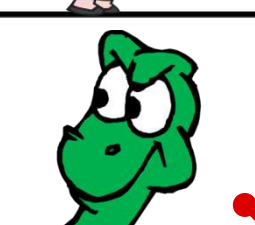
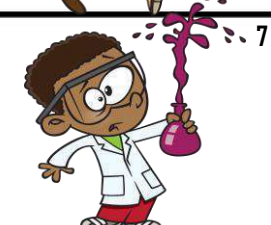
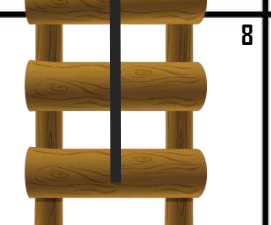
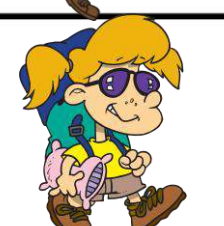
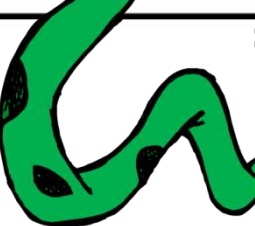

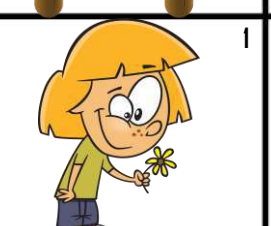
PAST SIMPLE TENSE - BOARD GAME

43 	42 	41 	40 
35 	36 	37 	38 
34 	33 	32 	31 
25 	26 	27 	28 
24 	23 	22 	21 
15 	16 	17 	18 
14 	13 	12 	11 
5 	6 	7 	8 
4 	3 	2 	1
			

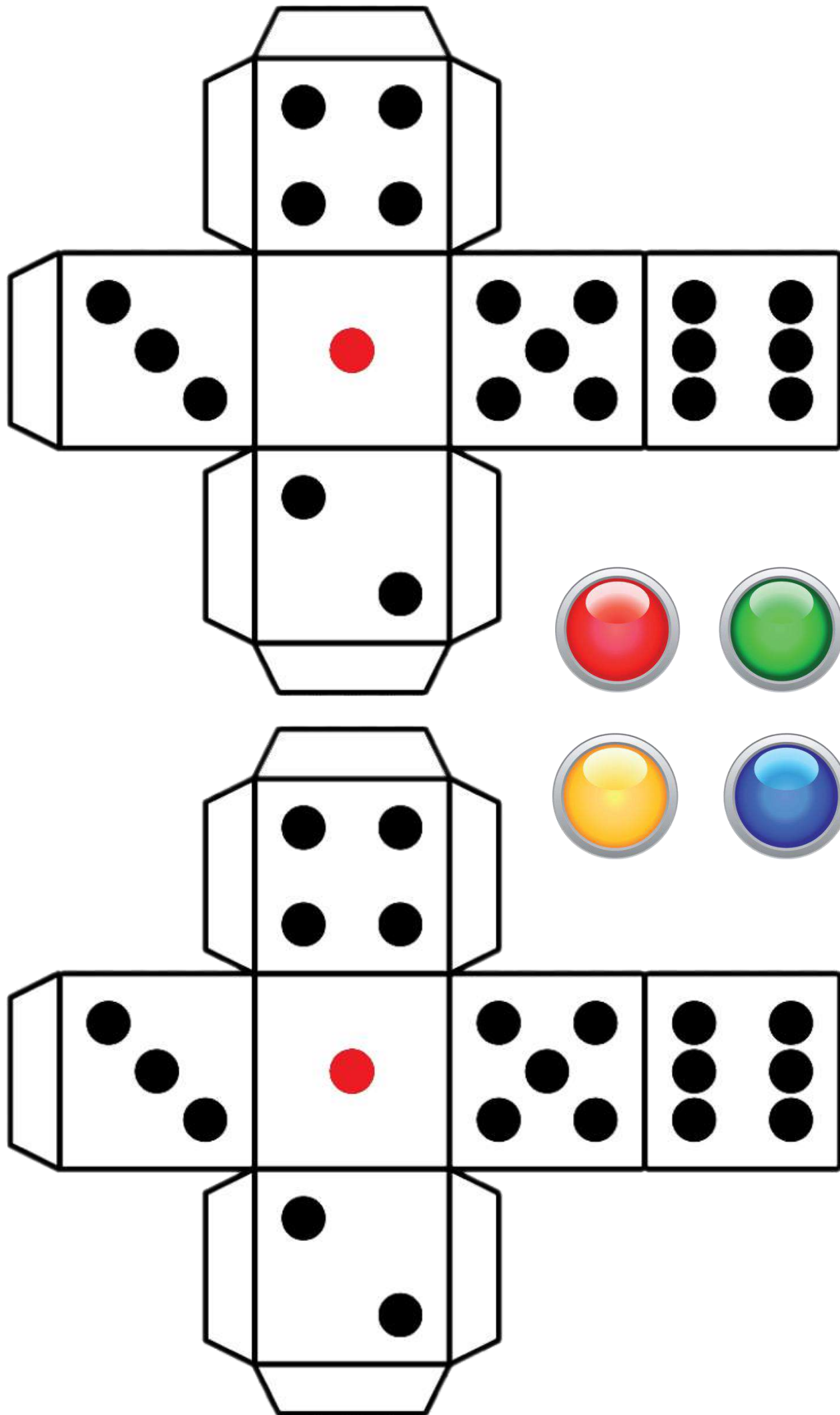



PAST SIMPLE OR PAST PERFECT?

SIMPLE PAST TENSE

We use Simple Past Tense to express action or actions started and finished at a specific time in the past.

Examples : I watched TV last night.

Henry painted the fence all day long yesterday.

PAST PERFECT TENSE

We use Past Perfect Tense to express that an action or actions happened before something else happened.

Examples : I had eaten dinner before they came
Tilly had seen that film before it was on TV.

A) Fill in the blanks with the correct forms of the verbs in brackets. Use Past Simple.

1. We _____ (go) on a cruise holiday last June. It _____ (be) really fantastic.
2. Logan _____ (collect) all the rubbish in the school garden and _____ (throw) it into the litter bin.
3. Florence _____ (eat) two sandwiches and _____ (drink) two glasses of lemonade at lunch.
4. Mr. Edwards _____ (drive) to the city center and _____ (buy) a new leather bag.
5. Benjamin hadn't known the answer to the question so he _____ (not raise) his hand up.
6. Teresa _____ (write) a letter for her aunt in Whales and _____ (put) it in an envelope yesterday afternoon.
7. James _____ (get up) early, _____ (wash) his face and _____ (brush) his teeth.

B) Fill in the blanks with the correct forms of the verbs in brackets. Use Past Perfect.

1. They _____ (finish) answering the questions before the bell rang.
2. When Matthew arrived at home, his wife _____ (cook) the meal.
3. Mrs. Lawrence _____ (open) the window before she went to bed.
4. Before Darcy entered this competition she _____ (practise) for two months.
5. Dexter _____ (not see) a skeleton before he visited the museum with his friends.
6. When the earthquake happened, we _____ (not finish) our work at the office.
7. Simon _____ (take) a shower before the guests arrived for the party.
8. The thief _____ (jump) out of the window by the time he opened the door.
9. I _____ (not watch) a horror film before we went to the cinema last Wednesday.
10. Mrs. Reid _____ (work) for the company for 30 years when she got retired last year.

C) Past Simple or Past Perfect? Read the sentences carefully and circle the correct options.

1. The robbers **left** / **had left** the bank when the policemen finally **arrived** / **had arrived**.
2. When the rain **started** / **had started**, the Atkinsons **finished** / **had finished** planting trees.
3. By the time Rebecca **went** / **had gone** into the store, she **got** / **had got** soaked.
4. Darcey **saw** / **had seen** this castle before she **came** / **had come** again last Sunday.
5. Mr. Palmer **didn't speak** / **hadn't spoken** any Chinese before he **moved** / **had moved** to Peking.
6. Sonny **got** / **had got** fainted by the time the ambulance **reached** / **had reached** the hospital.
7. When my mother **brought** / **had brought** me an apple, I **finished** / **had finished** my homework.
8. Mrs. Wilkinson **refused** / **had refused** to drive the car because she **had** / **had had** a terrible accident on the highway about a year ago.
9. I **didn't think** / **hadn't thought** of having a new house before I **saw** / **had seen** that ad on TV.
10. My uncle **didn't try** / **hadn't tried** Italian food before **went** / **had gone** to that restaurant.



PAST SIMPLE OR PAST PERFECT?

ANSWER KEY

A) Fill in the blanks with the correct forms of the verbs in brackets. Use Past Simple.

1. went - was
2. collected - threw
3. ate - drank
4. drove - bought
5. didn't raise
6. wrote - put
7. got up - washed - brushed

B) Fill in the blanks with the correct forms of the verbs in brackets. Use Past Perfect.

1. had finished
2. had cooked
3. had opened
4. had practised
5. hadn't seen
6. hadn't finished
7. had taken
8. had jumped
9. hadn't watched
10. had worked

C) Past Simple or Past Perfect? Read the sentences carefully and circle the correct options.

1. had left - arrived
2. started - had finished
3. went - had got
4. had seen - came
5. hadn't spoken - moved
6. had got - reached
7. brought - had finished
8. refused - had had
9. hadn't thought - saw
10. hadn't tried - went

AT THE HOSPITAL PICTURE DICTIONARY !



doctor



dentist



nurse



surgeon



patient



secretary

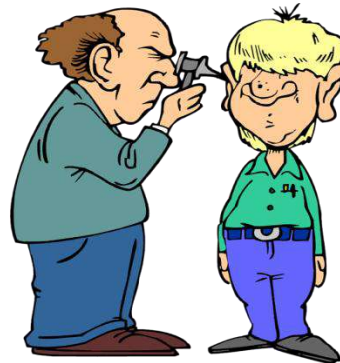

examination

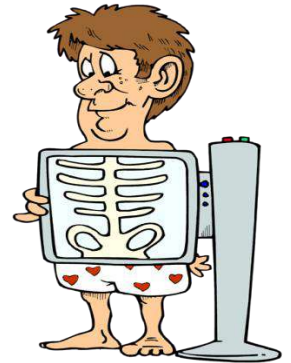

x-ray



ambulance

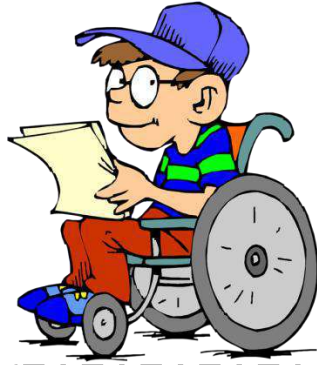

wheelchair



walker



stretcher

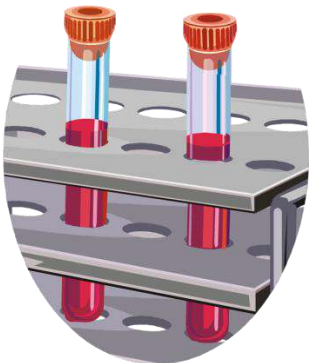

blood test

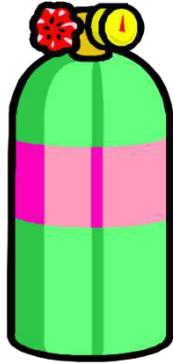

oxygen tank



hot water
bottle



stethoscope

AT THE HOSPITAL PICTURE DICTIONARY 2



tablets



drop

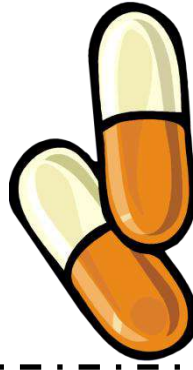

capsules

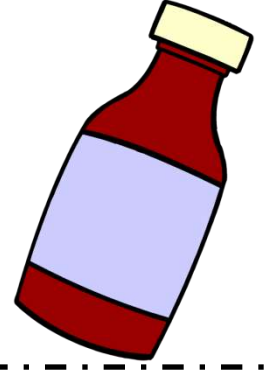

syrup



cream

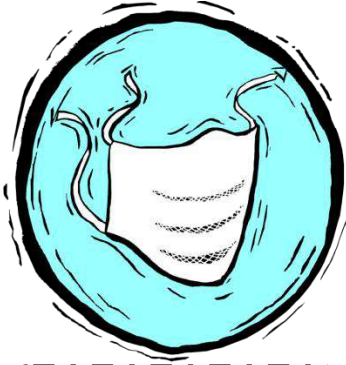

mask



gloves



cap



blood pressure monitor



microscope



bed



oxygen mask

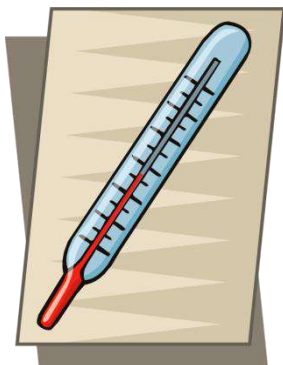

thermometer



syringe

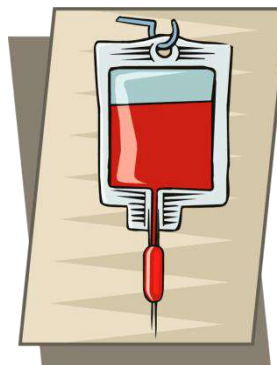

drip



crutches

AT THE HOSPITAL PICTURE DICTIONARY 1



doctor



dentist



nurse



surgeon



patient



secretary



examination

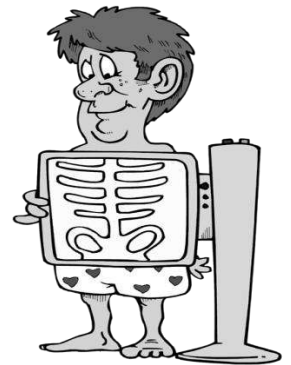

x-ray

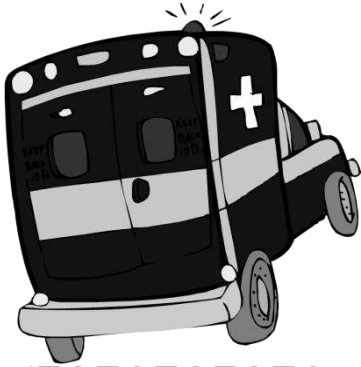

ambulance



wheelchair



walker



stretcher

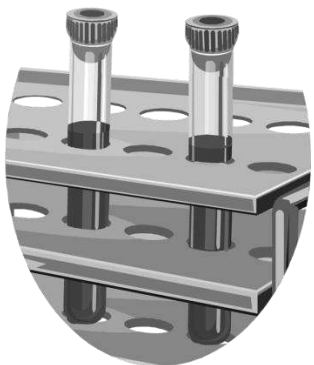

blood test

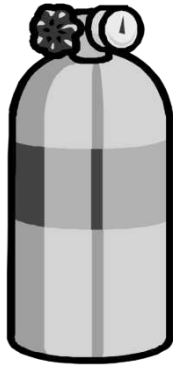

oxygen tank



hot water
bottle



stethoscope

AT THE HOSPITAL PICTURE DICTIONARY 2



tablets



drop



capsules



syrup

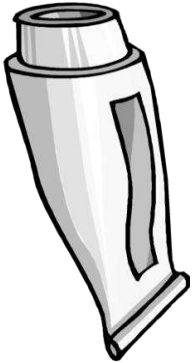

cream



mask



gloves



cap

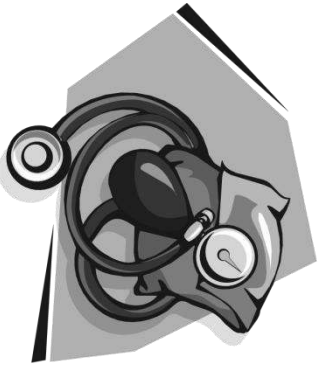

blood pressure monitor



microscope



bed



oxygen mask

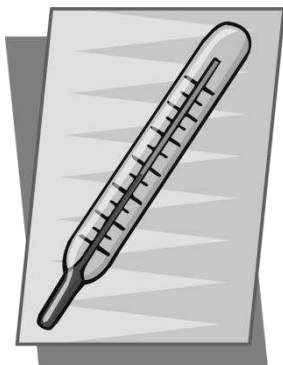

thermometer



syringe



drip



crutches

AT THE HOSPITAL VOCABULARY MATCHING WORKSHEET !

Choose the correct words from the list below and write them under the correct pictures

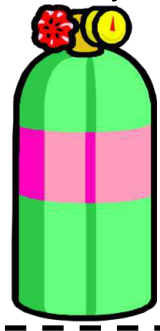
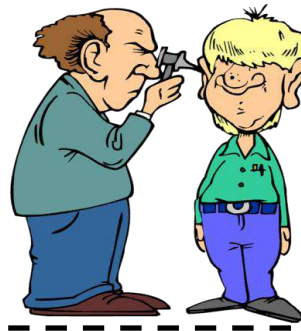



WORD LIST

- doctor
- dentist
- nurse
- surgeon
- patient
- secretary
- examination
- x-ray
- ambulance
- wheelchair
- walker
- stretcher
- blood test
- oxygen tank
- hot water bottle
- stethoscope

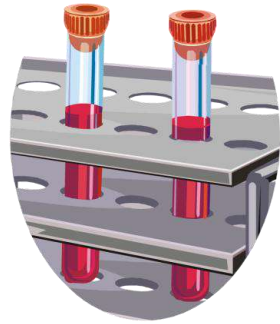
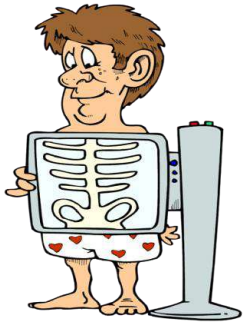





AT THE HOSPITAL VOCABULARY MATCHING WORKSHEET 2

Choose the correct words from the list below and write them under the correct pictures

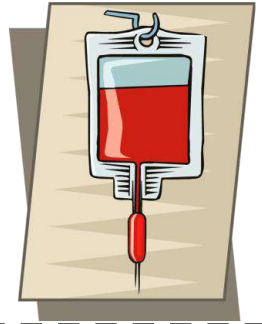
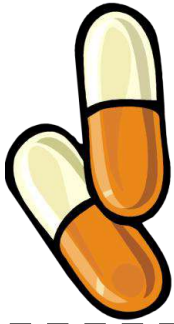

[]

[]

[]

[]



WORD LIST

- tablets
- drop
- capsules
- syrup
- cream
- mask
- gloves
- cap
- blood pressure monitor
- microscope
- bed
- oxygen mask
- thermometer
- syringe
- drip
- crutches

[]

[]



[]

[]

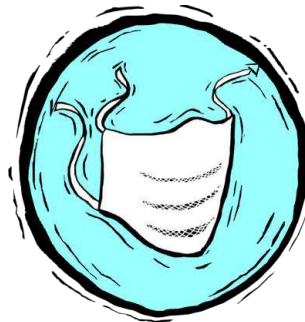

[]

[]

[]

[]

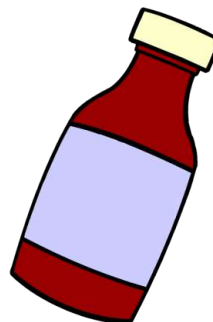
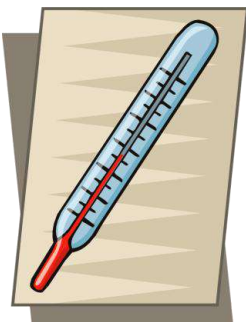

[]

[]

[]

[]

AT THE HOSPITAL VOCABULARY MATCHING WORKSHEET | ANSWER KEY

Choose the correct words from the list below and write them under the correct pictures



nurse



wheelchair



examination

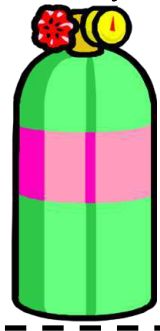

oxygen tank



ambulance



doctor

WORD LIST

- doctor
- dentist
- nurse
- surgeon
- patient
- secretary
- examination
- x-ray
- ambulance
- wheelchair
- walker
- stretcher
- blood test
- oxygen tank
- hot water bottle
- stethoscope

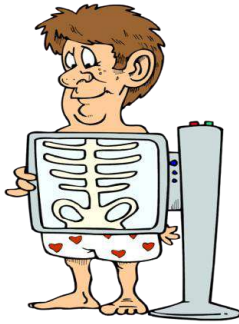

x-ray

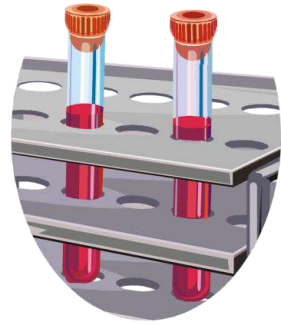

blood test



stretcher



surgeon



secretary



stethoscope



walker



patient



dentist



hot water bottle

AT THE HOSPITAL VOCABULARY MATCHING WORKSHEET 2 ANSWER KEY

Choose the correct words from the list below and write them under the correct pictures

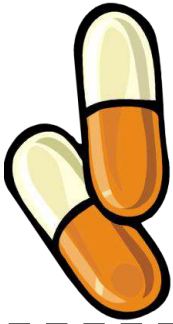

capsules



oxygen mask



cap

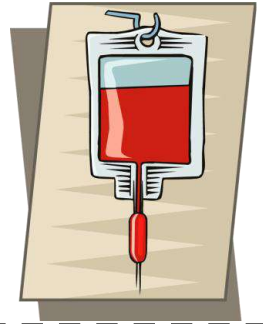

drip



microscope



tablets

WORD LIST

- tablets
- drop
- capsules
- syrup
- cream
- mask
- gloves
- cap
- blood pressure monitor
- microscope
- bed
- oxygen mask
- thermometer
- syringe
- drip
- crutches



gloves



crutches



drop



syringe

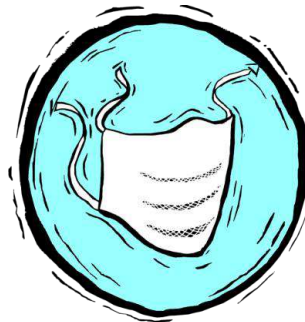

mask



bed

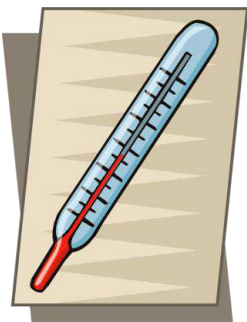

thermometer



cream

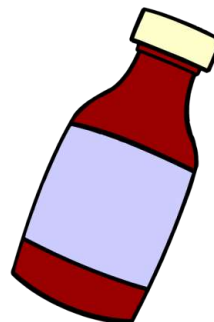

syrup

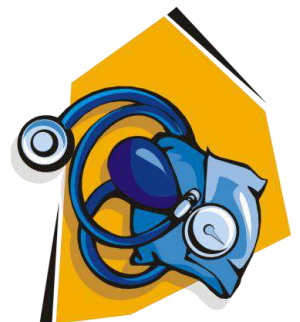

blood pressure monitor

AT THE HOSPITAL WORD SEARCH PUZZLE !

Find and circle the words in the word search puzzle and number the pictures

u	x	t	u	s	u	r	g	e	o	n	z	x	i	w
d	n	h	k	c	v	o	v	e	l	t	d	w	s	r
r	g	s	q	n	g	x	p	m	h	y	d	h	e	f
t	l	t	r	c	l	y	x	r	a	y	e	e	c	a
k	v	e	d	p	f	g	o	i	d	h	n	e	r	x
h	o	t	w	a	t	e	r	b	o	t	t	l	e	j
t	i	h	a	t	h	n	n	l	c	h	i	c	t	a
l	i	o	g	i	y	t	m	o	t	r	s	h	a	m
w	o	s	n	e	t	a	m	e	o	r	t	a	r	b
a	d	c	u	n	c	n	r	q	r	g	l	i	y	u
l	v	o	r	t	n	k	v	y	r	u	s	r	s	l
k	q	p	s	z	b	e	c	f	k	n	n	r	a	a
e	a	e	e	e	x	a	m	i	n	a	t	i	o	n
r	k	g	s	t	r	e	t	c	h	e	r	l	r	c
s	b	l	o	o	d	t	e	s	t	z	l	t	b	e

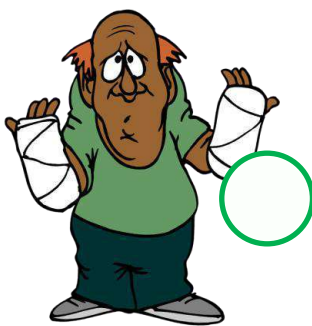
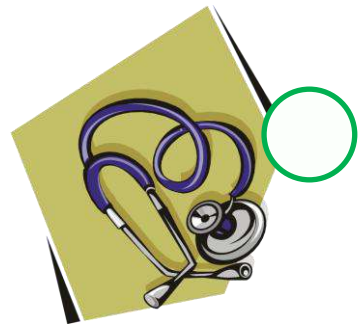
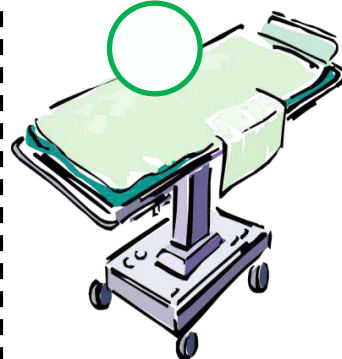
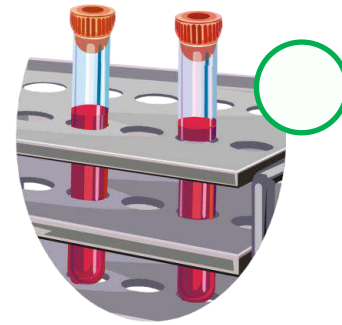
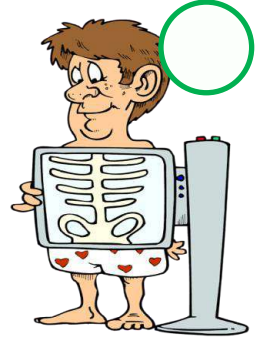
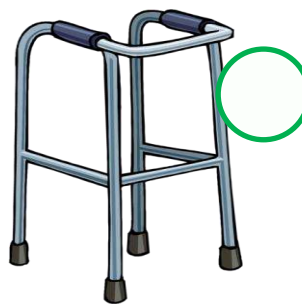
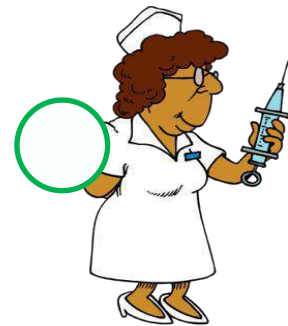
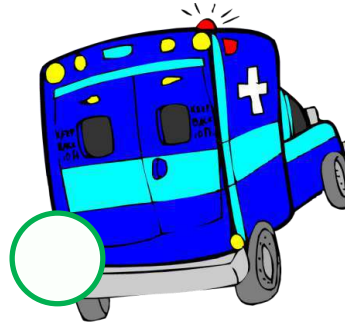
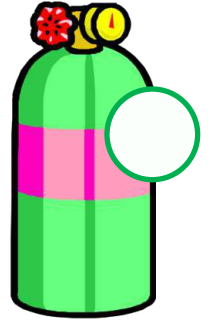
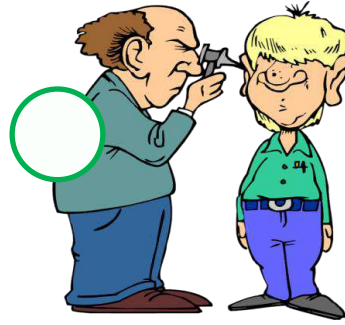

1. doctor
2. dentist
3. nurse
4. surgeon
5. patient
6. secretary
7. examination
8. x-ray
9. ambulance
10. wheelchair
11. walker
12. stretcher
13. blood test
14. oxygen tank
15. hot water bottle
16. stethoscope

AT THE HOSPITAL WORD SEARCH PUZZLE 2

Find and circle the words in the word search puzzle and number the pictures

b	l	o	o	d	p	r	e	s	s	u	r	e	m	o	n	i	t	o	r
k	w	n	g	l	z	k	i	h	c	c	a	p	s	u	l	e	s	o	h
e	p	x	q	t	a	t	h	e	r	m	o	m	e	t	e	r	w	r	m
k	x	r	c	o	x	k	j	m	u	l	o	p	q	o	z	j	p	g	s
a	t	i	p	i	n	a	k	u	t	p	x	s	u	m	s	z	r	t	r
f	w	y	q	c	a	p	f	v	c	y	y	y	e	z	f	t	z	c	e
f	n	l	u	r	n	n	d	h	m	g	r	i	p	v	a	e	a	c	
f	f	s	y	r	i	n	g	e	e	a	e	u	m	g	k	b	e	d	s
f	g	q	k	l	d	f	h	g	s	s	n	p	y	m	u	l	n	k	t
h	z	q	m	e	p	f	k	w	p	k	m	p	a	d	s	e	w	d	f
y	m	i	c	r	o	s	c	o	p	e	a	d	e	v	x	t	b	v	z
m	c	e	f	i	d	d	r	i	s	x	s	t	w	i	i	s	z	c	s
g	l	o	v	e	s	r	e	k	t	x	k	h	w	m	m	t	h	t	k
u	k	i	i	t	m	o	a	h	t	d	d	q	d	r	i	p	i	t	k
p	c	d	p	m	h	p	m	h	s	c	p	i	e	z	k	e	r	y	g

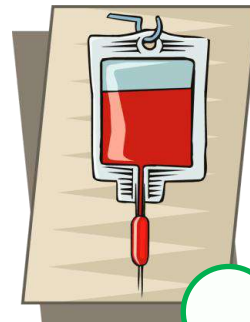
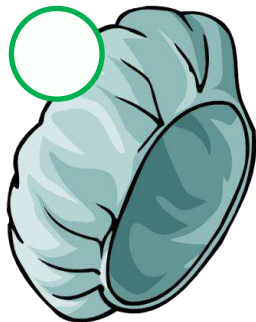
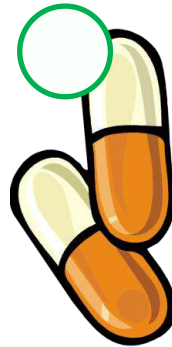
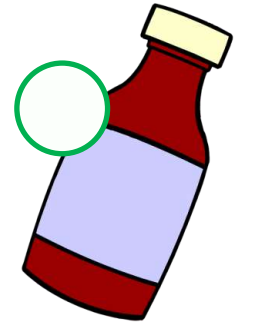
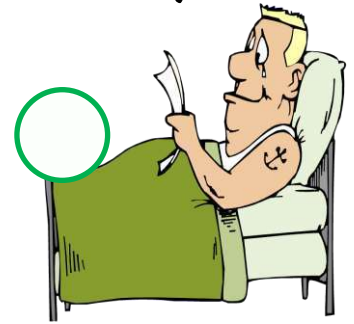

1. tablets
2. drop
3. capsules
4. syrup
5. cream
6. mask
7. gloves
8. cap
9. blood pressure monitor
10. microscope
11. bed
12. oxygen mask
13. thermometer
14. syringe
15. drip
16. crutches

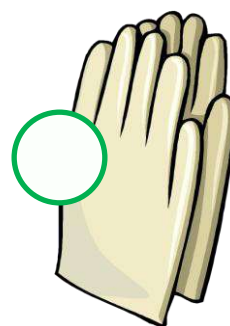
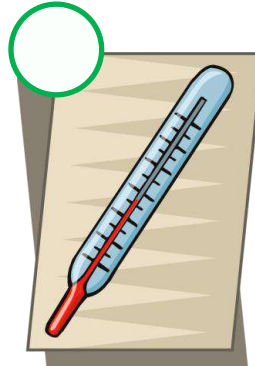
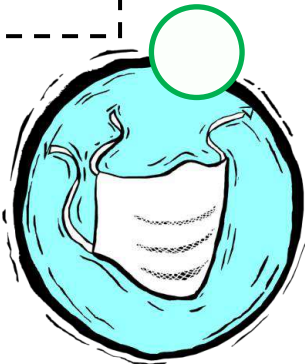

AT THE HOSPITAL WORD SEARCH PUZZLE 1 ANSWER KEY

Find and circle the words in the word search puzzle and number the pictures

u	x	t	u	s	u	r	g	e	o	n	z	x	i	w
d	n	h	k	c	v	o	v	e	l	t	d	w	s	r
r	g	s	q	n	g	x	p	m	h	y	d	h	e	f
t	l	t	r	c	l	y	x	r	a	y	e	e	c	a
k	v	e	d	p	f	g	o	i	d	h	n	e	r	x
h	o	t	w	a	t	e	r	b	o	t	t	l	e	j
t	i	h	a	t	h	n	n	l	c	h	i	c	t	a
l	i	o	g	i	y	t	m	o	t	r	s	h	a	m
w	o	s	n	e	t	a	m	e	o	r	t	a	r	b
a	d	c	u	n	c	n	r	q	r	g	l	i	y	u
l	v	o	r	t	n	k	v	y	r	u	s	r	s	l
k	q	p	s	z	b	e	c	f	k	n	n	r	a	a
e	a	e	e	e	x	a	m	i	n	a	t	i	o	n
r	k	g	s	t	r	e	t	c	h	e	r	l	r	c
s	b	l	o	o	d	t	e	s	t	z	l	t	b	e

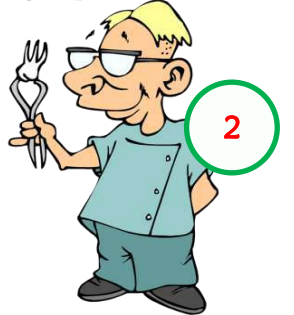
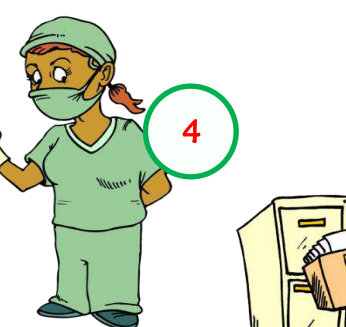
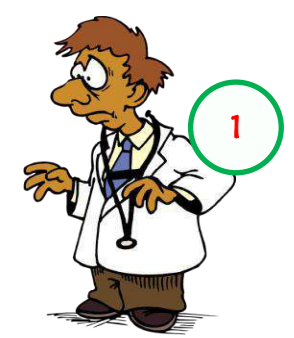
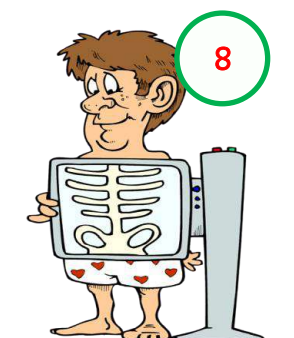
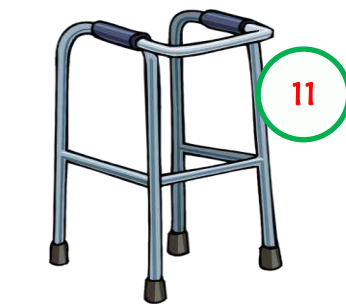
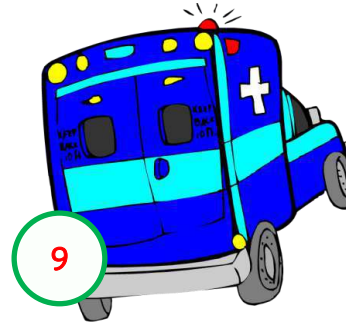
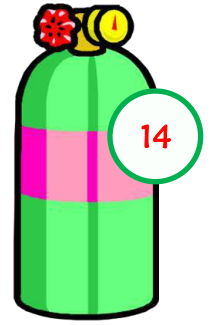
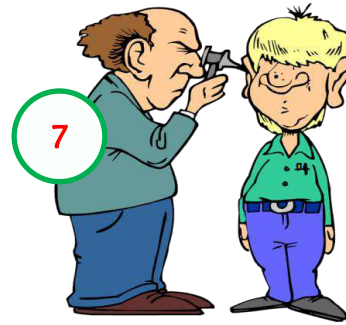

1. doctor
2. dentist
3. nurse
4. surgeon
5. patient
6. secretary
7. examination
8. x-ray
9. ambulance
10. wheelchair
11. walker
12. stretcher
13. blood test
14. oxygen tank
15. hot water bottle
16. stethoscope

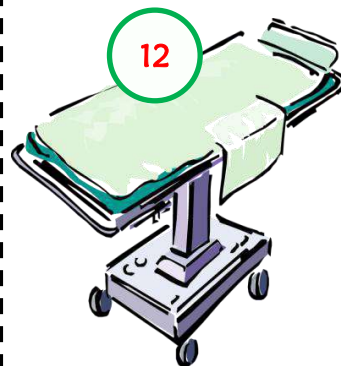
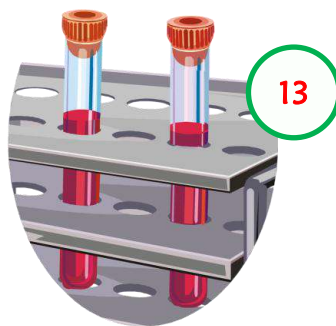

AT THE HOSPITAL WORD SEARCH PUZZLE 2 ANSWER KEY

Find and circle the words in the word search puzzle and number the pictures

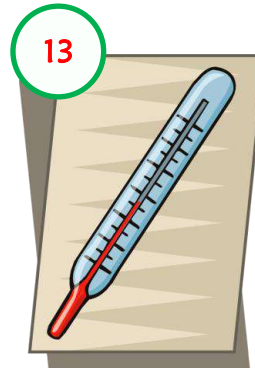
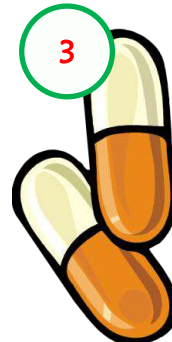
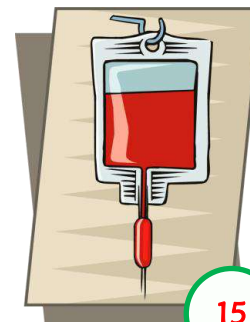
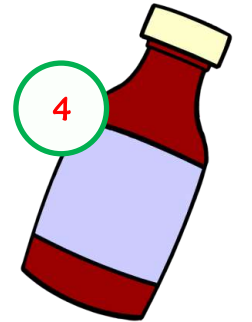
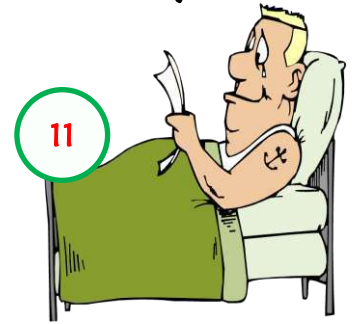
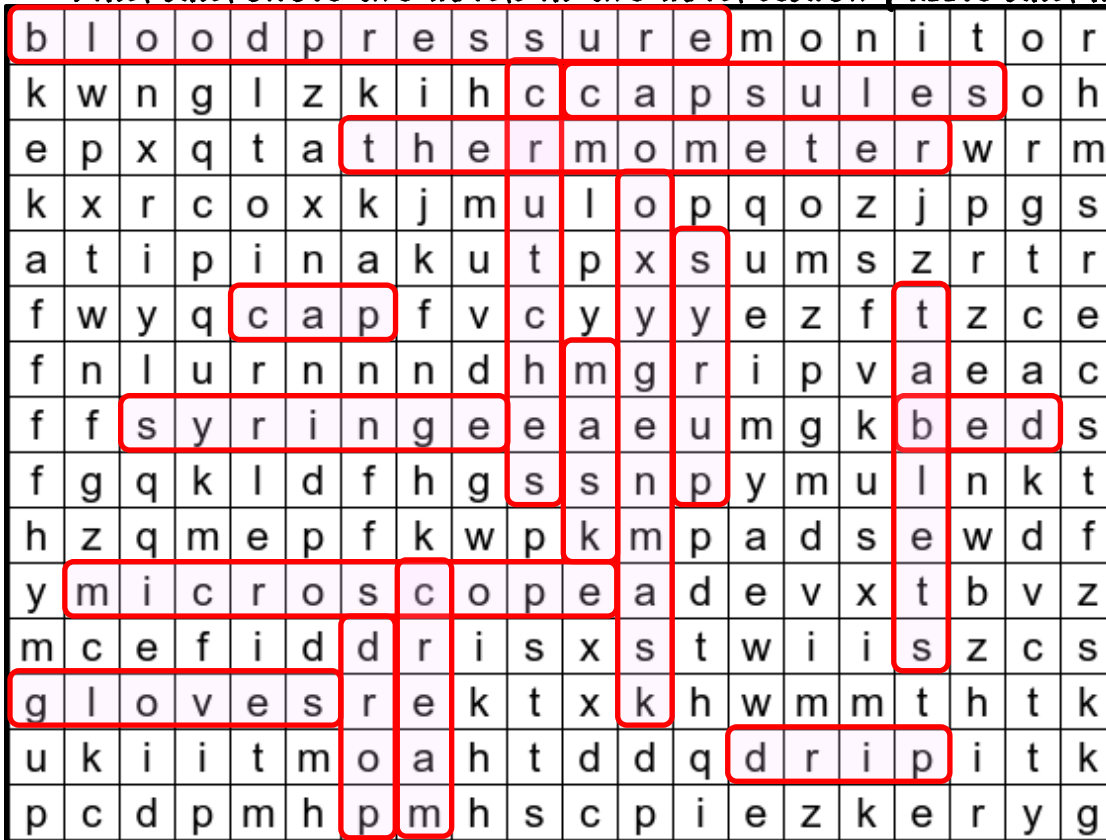

1. tablets
2. drop
3. capsules
4. syrup
5. cream
6. mask
7. gloves
8. cap
9. blood pressure monitor
10. microscope
11. bed
12. oxygen mask
13. thermometer
14. syringe
15. drip
16. crutches

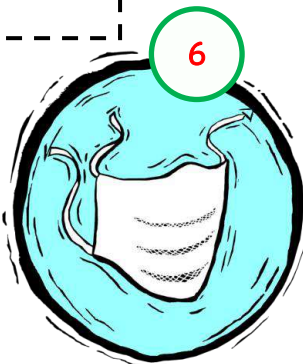

6

13

7

9

AT THE HOSPITAL CROSSWORD PUZZLE !

Look at the numbers on the pictures and write the hospital vocabulary in the crossword puzzle



14



9



8

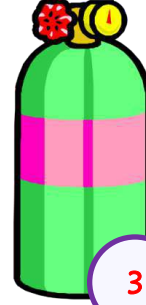

3

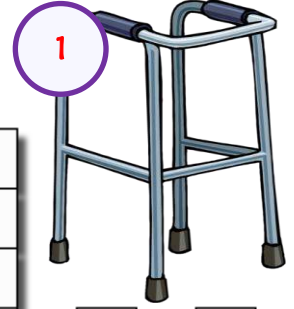

1

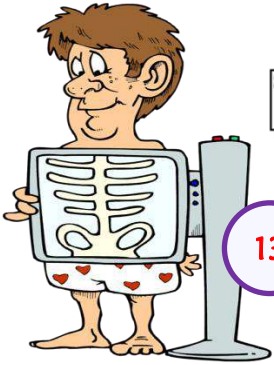

13



12



15

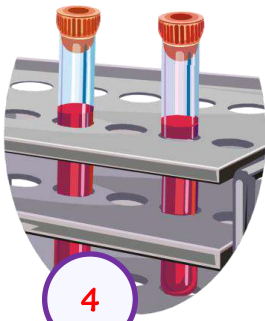

4



11



16

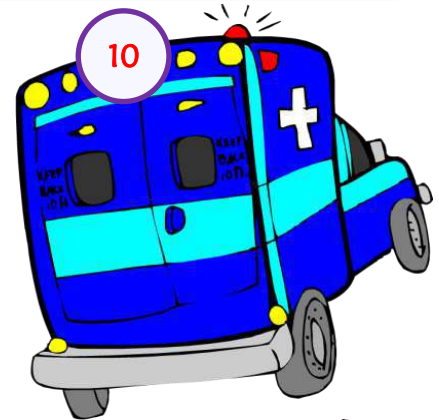

10



2



6



5

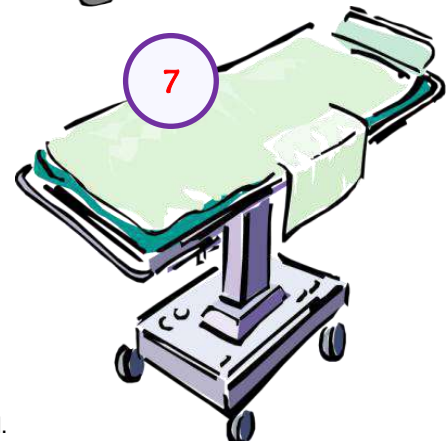

7

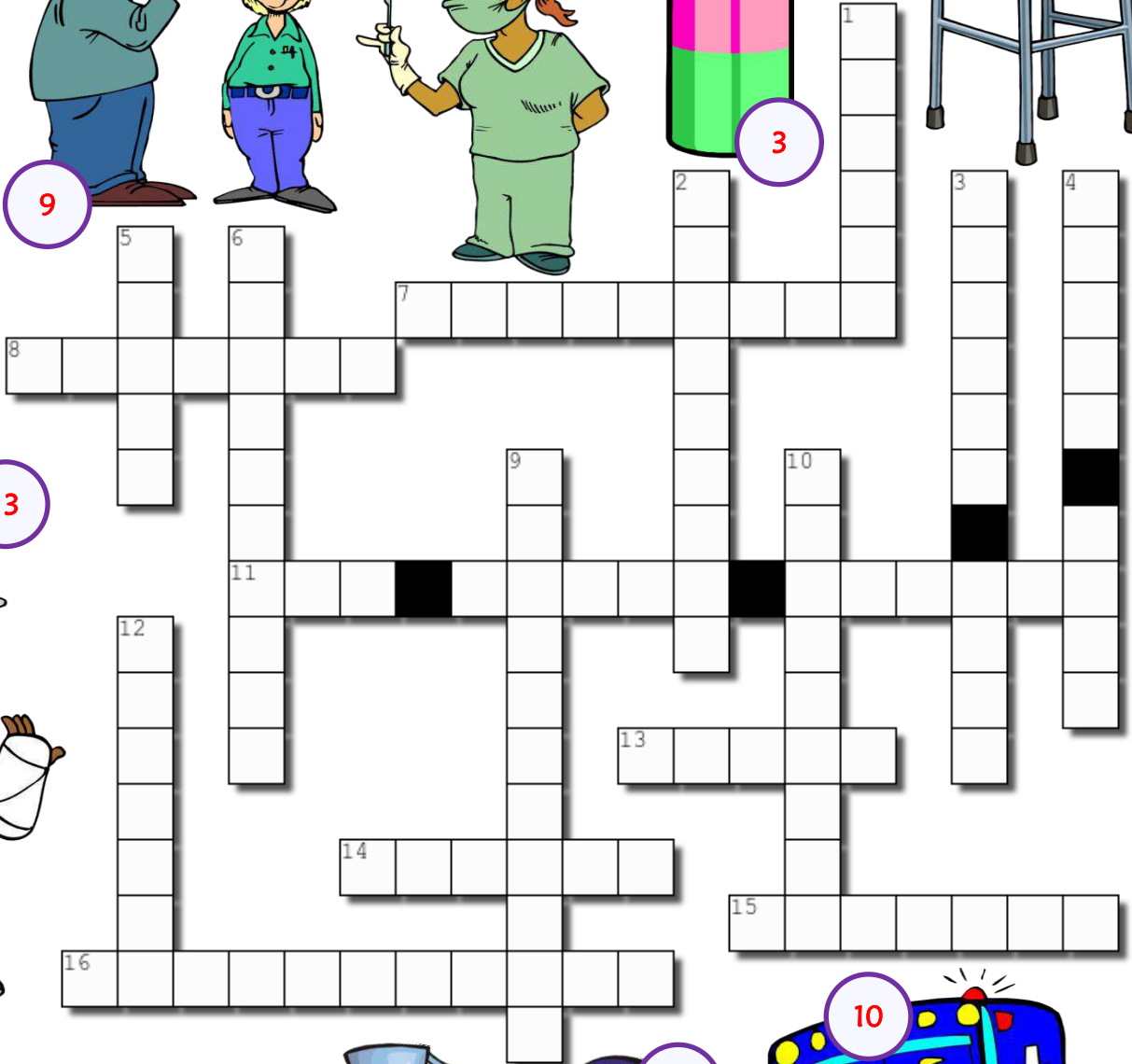

ANSWER KEY

Across

7. stretcher

8. surgeon

11. hot water bottle

13. x-ray

14. doctor

15. dentist

16. stethoscope

Down

1. walker

2. secretary

3. oxygen tank

4. blood test

5. nurse

6. wheelchair

9. examination

10. ambulance

12. patient

AT THE HOSPITAL CROSSWORD PUZZLE 2

Look at the numbers on the pictures and write the hospital vocabulary in the crossword puzzle

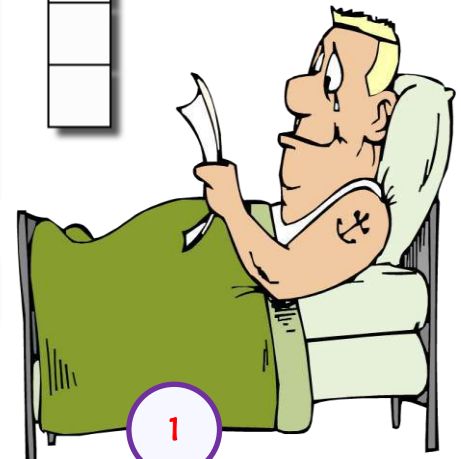
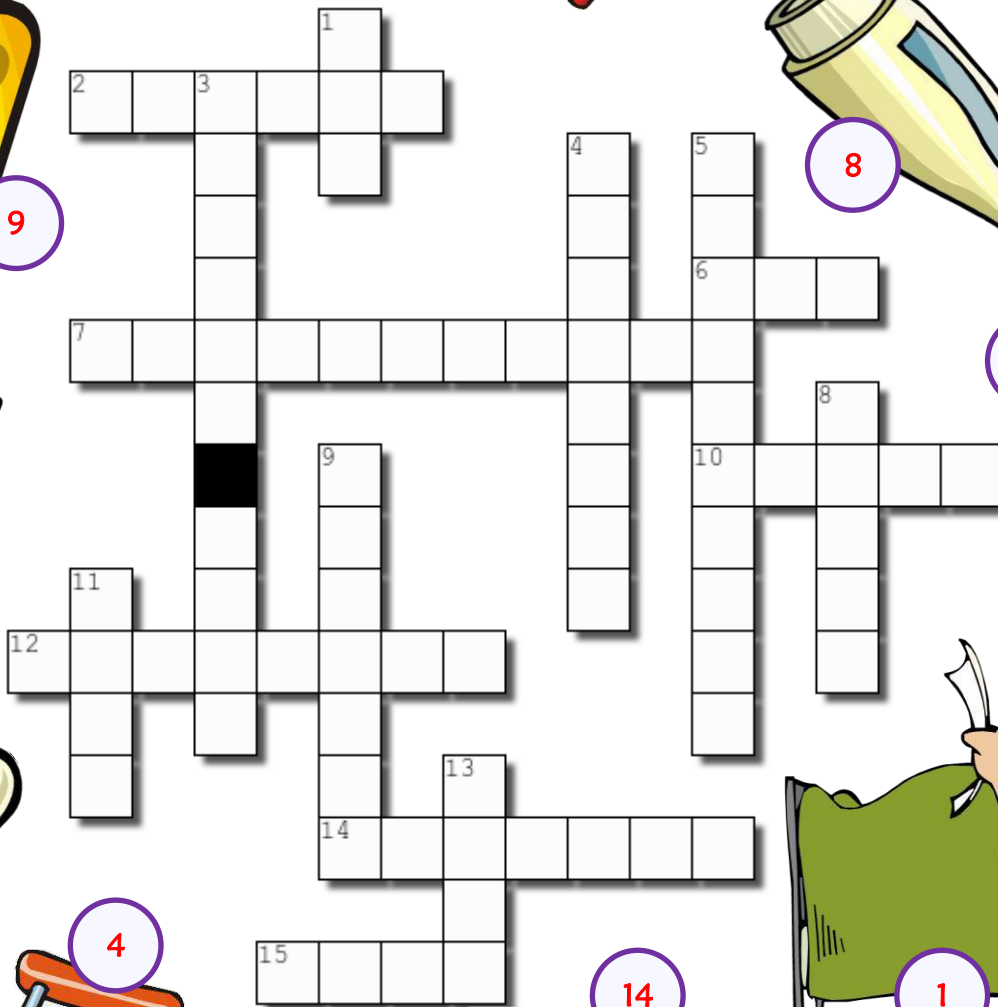
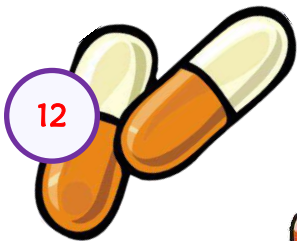
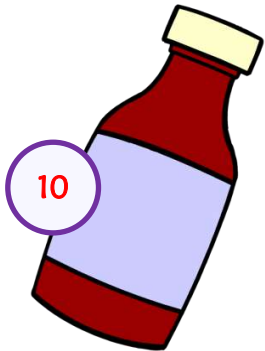
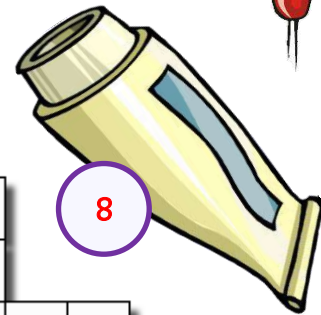
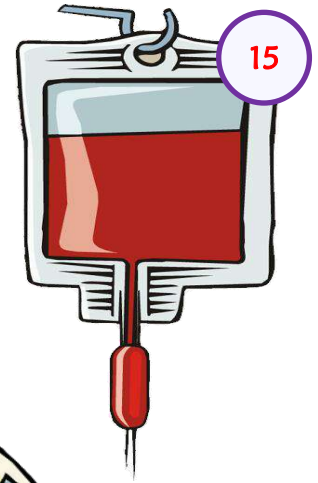
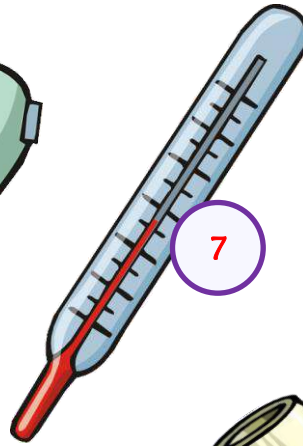
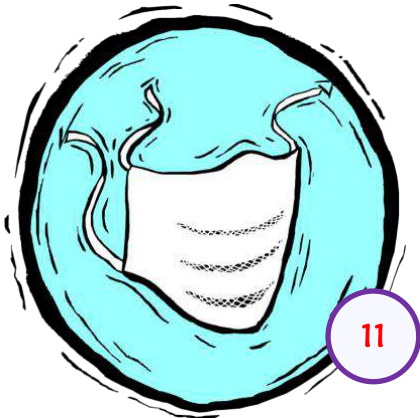

ANSWER KEY

Across

2. gloves

6. cap

7. thermometer

10. syrup

12. capsules

14. syringe

15. drip

Down

1. bed

3. oxygen mask

4. crutches

5. microscope

8. cream

9. tablets

11. mask

13. drop

AT THE HOSPITAL MISSING LETTERS IN WORDS !

Write the missing letters in the boxes to complete the hospital vocabulary

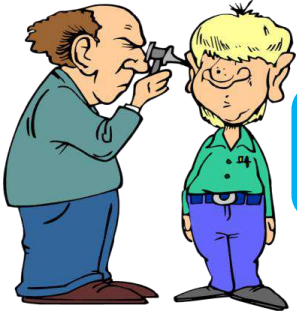

_x_m_n_t__n

d_ct_r



d_nt_st



p_t__nt



s_cr_t_ry

x-r_y

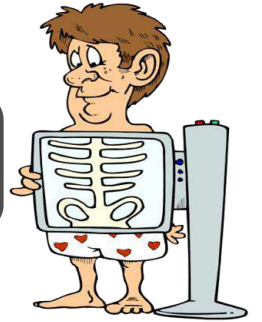

n_rs_



wh__lch__r



s_rg__n

_mb_l_nc_



w_lk_r



h_t w_tr bttl_

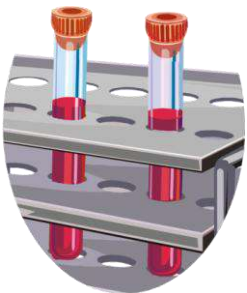

t_st t_b_

str_tch_r



st_th_sc_p_

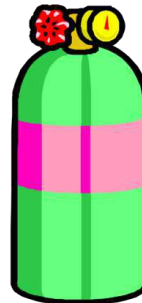

_xyg_n t_nk

AT THE HOSPITAL MISSING LETTERS IN WORDS 2

Write the missing letters in the boxes to complete the hospital vocabulary



t_bl_ts

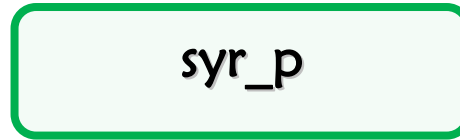

syr_p

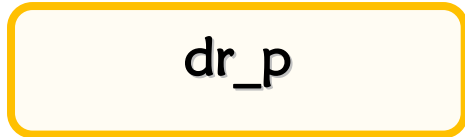

dr_p



c_ps_l_s

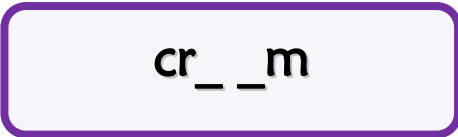

cr__m



m_sk

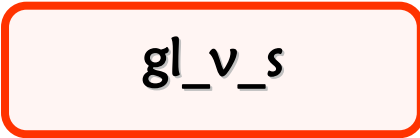
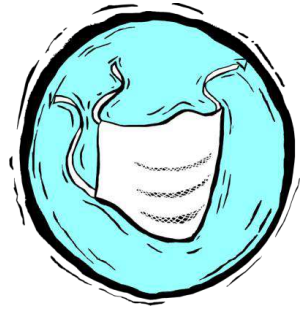

gl_v_s



b_d

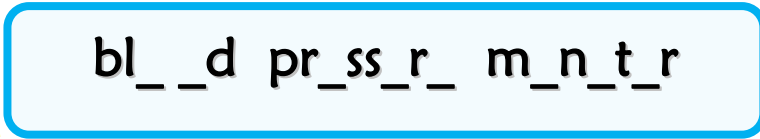

bl__d pr_ss_r_m_n_t_r

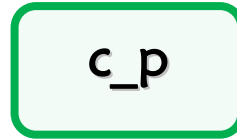

c_p

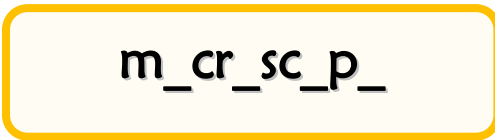

m_cr_sc_p_

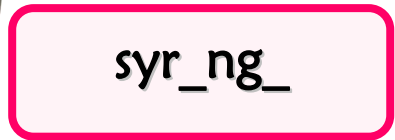

syr_ng_

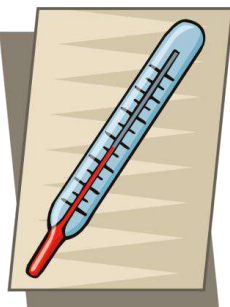

th_rm_m_t_r

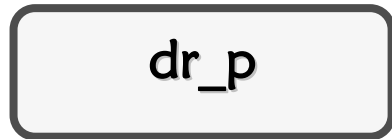

dr_p

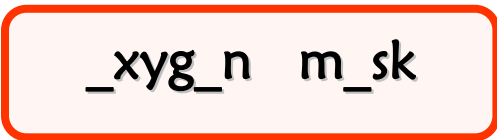
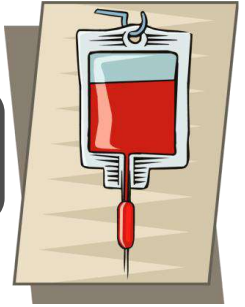

_xyg_n m_sk

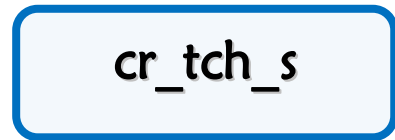

cr_tch_s

AT THE HOSPITAL MISSING LETTERS IN WORDS | ANSWER KEY

Write the missing letters in the boxes to complete the hospital vocabulary

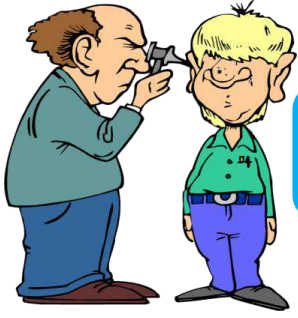

examination

doctor



dentist



patient



secretary

x-ray

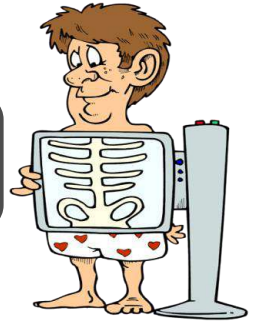

nurse



wheelchair



surgeon

ambulance



walker



hot water bottle

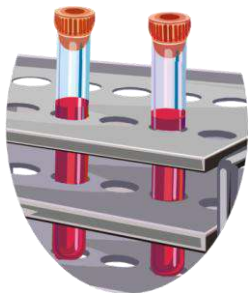

test tube

stretcher



stethoscope

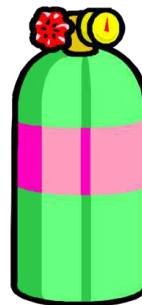

oxygen tank

AT THE HOSPITAL MISSING LETTERS IN WORDS 2 ANSWER KEY

Write the missing letters in the boxes to complete the hospital vocabulary



tablets

syrup

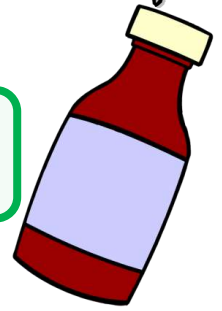

drop

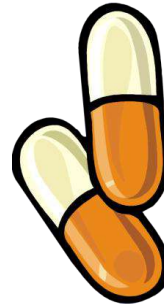

capsules



cream

mask

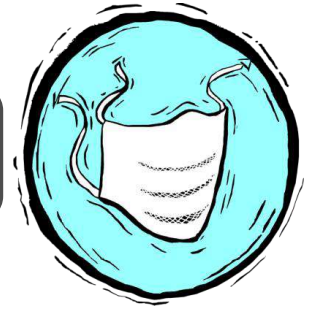

gloves



bed

blood pressure monitor

cap



microscope



syringe

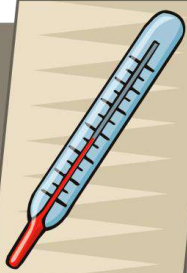

thermometer

drip

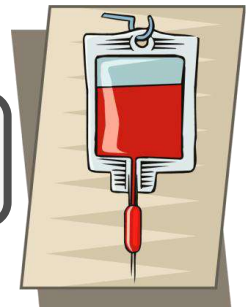

oxygen mask



crutches

AT THE HOSPITAL UNSCRAMBLE THE WORDS !

Unscramble the hospital vocabulary and number the pictures

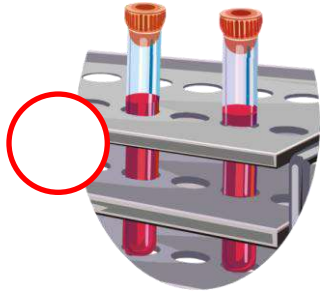
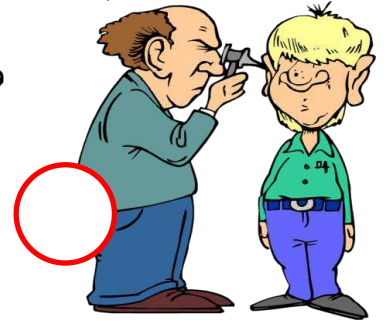
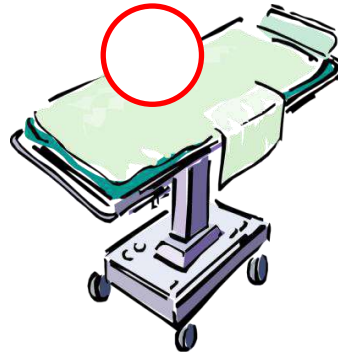

1. rcdoto

2. ttdise

3. ruesn

4. ouegnsr

5. inaetpt

6. rayertecs

7. enxmiointaa

8. x-ary

9. emacaubln

10. rilahcechw

11. relawk

12. tcreseht

13. dolob ttes

14. yexong aknt

15. oth twear tleotb

16. ssptectehoo

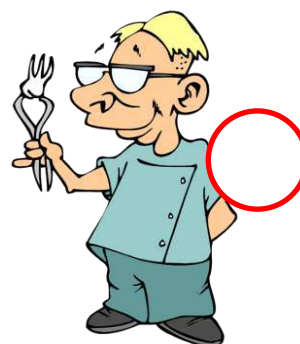
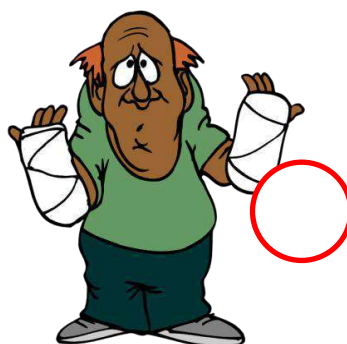
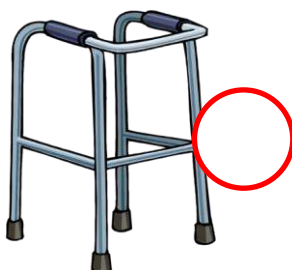
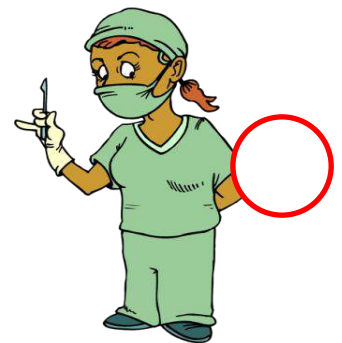
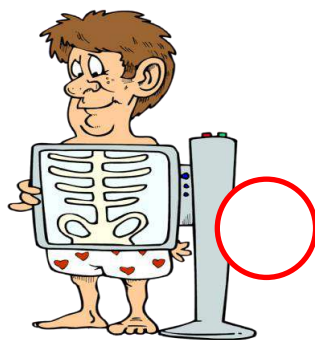
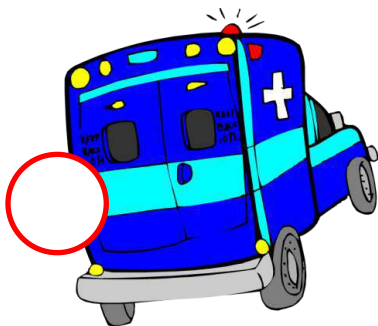
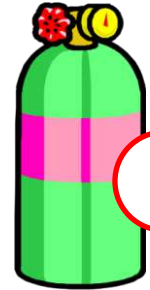

AT THE HOSPITAL UNSCRAMBLE THE WORDS 2

Unscramble the hospital vocabulary and number the pictures

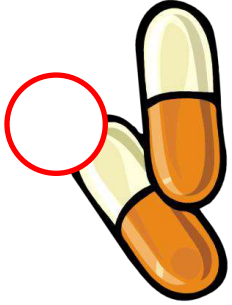
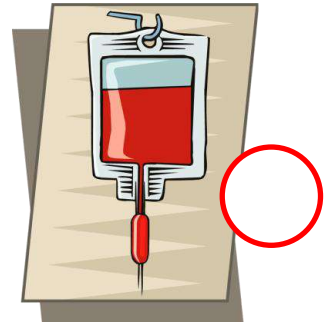
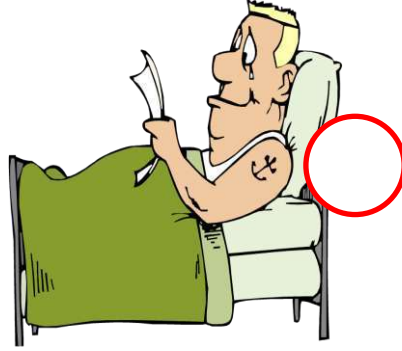

1. baettsl _____
2. prdo _____
3. plusseca _____
4. syurp _____
5. emarc _____
6. msak _____
7. elsovg _____
8. apc _____
9. ldo bo usersper onrmiot _____

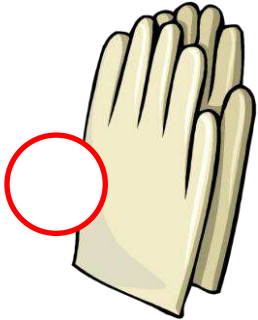
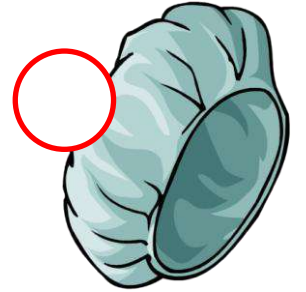

10. cosrepimoc _____
11. bde _____
12. egyoxn sakm _____
13. rmtoreemteh _____
14. nsyierg _____
15. pdri _____
16. hreccuts _____

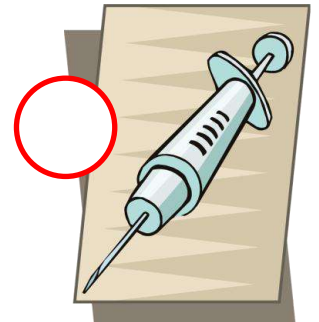
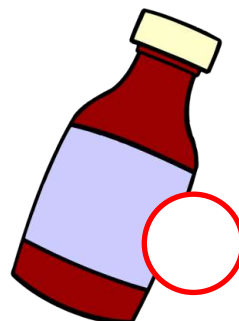
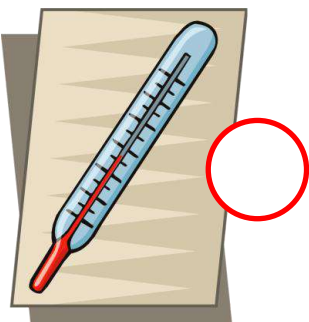
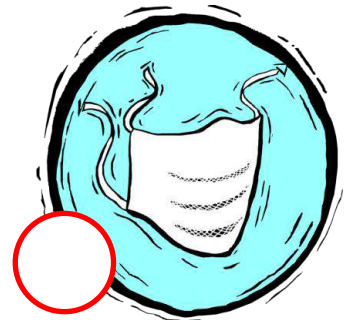

AT THE HOSPITAL UNSCRAMBLE THE WORDS | ANSWER KEY

Unscramble the hospital vocabulary and number the pictures

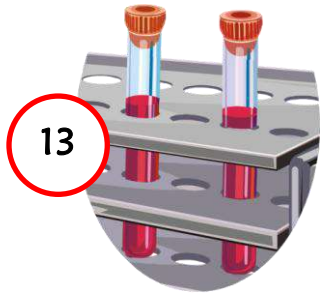
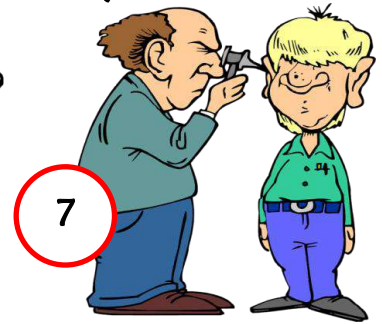
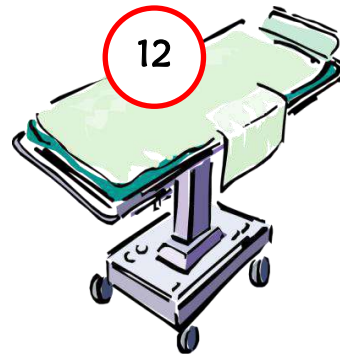

1. rcdoto

doctor

2. ttdisne

dentist

3. ruesn

nurse

4. ouegnsr

surgeon

5. inaetpt

patient

6. rayertecs

secretary

7. enxmiointaa

examination

8. x-ary

x-ray

9. emacaubln

ambulance

10. rilahcechw

wheelchair

11. relawk

walker

12. tcreseht

stretcher

13. dolob ttes

blood test

14. yexong aknt

oxygen tank

15. oth twear tleotb

hot water bottle

16. ssptectehoo

stethoscope

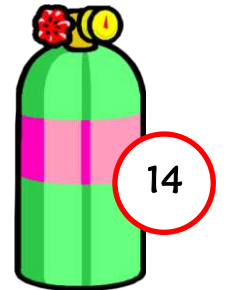
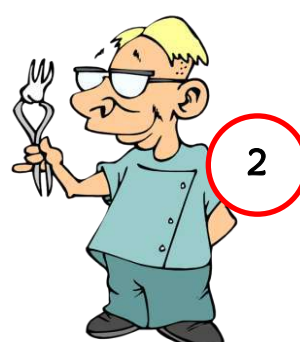
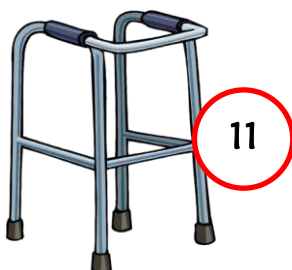
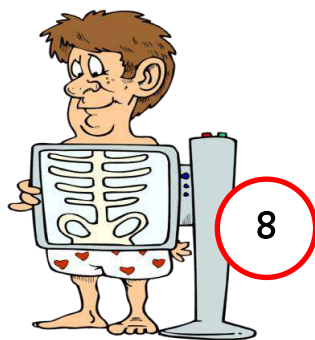
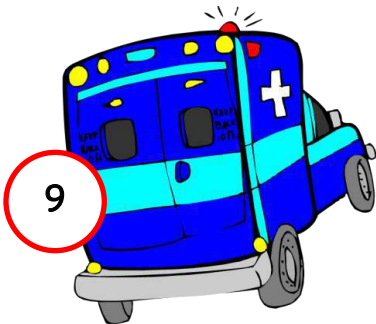

AT THE HOSPITAL UNSCRAMBLE THE WORDS 2 ANSWER KEY

Unscramble the hospital vocabulary and number the pictures



10



12

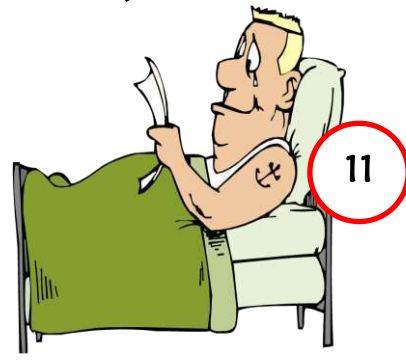

11

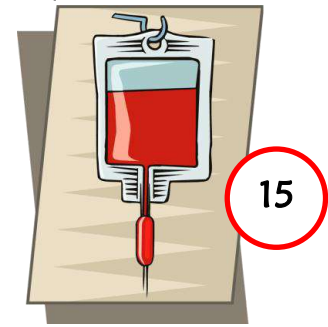

15

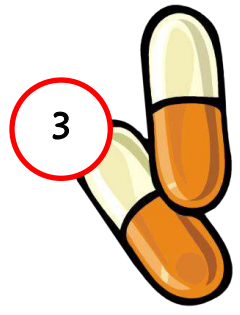

3

1. baettsl

tablets

2. prdo

drop

3. plusseca

capsules

4. syurp

syrup

5. emarc

cream

6. msak

mask

7. elsovg

gloves

8. apc

cap

9. ldo bo usersper onrmiot

blood pressure monitor

10. cosrepimoc

microscope

11. bde

bed

12. egyoxn sakm

oxygen mask

13. rmtoreemteh

thermometer

14. nsyierg

syringe

15. pdri

drip

16. hreccuts

crutches

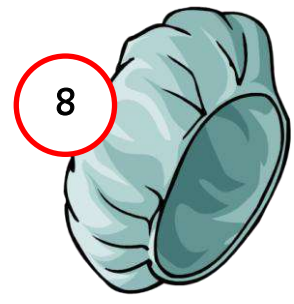

8

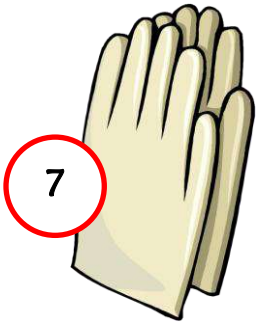

7



16



1

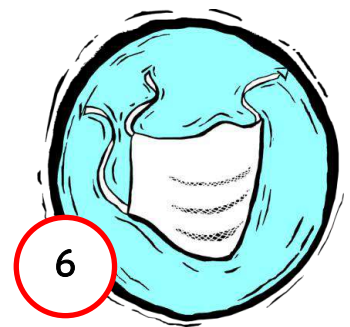

6



2



5

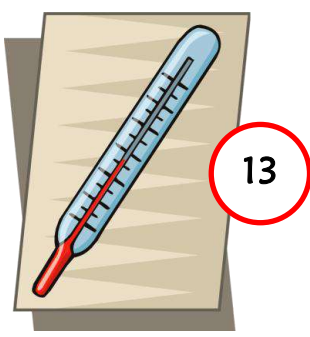

13



9

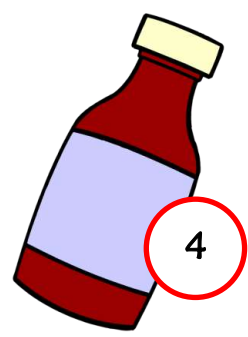

4

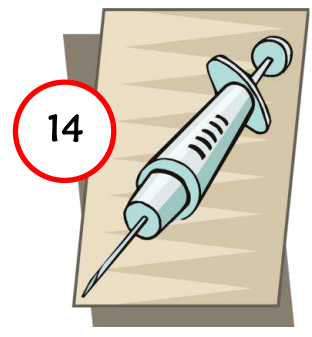

14

AT THE HOSPITAL MULTIPLE CHOICE TEST !

Look at the pictures, choose and circle the correct option.



- a) x-ray
- b) doctor
- c) walker
- d) oxygen tank



- a) patient
- b) stethoscope
- c) stretcher
- d) dentist



- a) hot water bottle
- b) secretary
- c) nurse
- d) ambulance

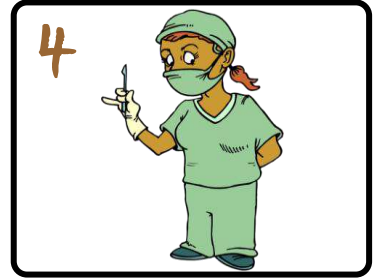

- a) surgeon
- b) wheelchair
- c) examination
- d) test tube



- a) stethoscope
- b) patient
- c) dentist
- d) stretcher



- a) walker
- b) test tube
- c) secretary
- d) nurse

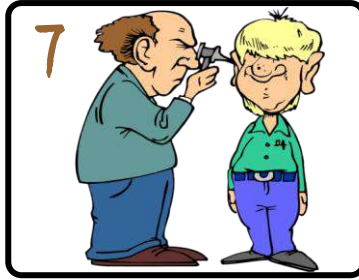

- a) wheelchair
- b) examination
- c) surgeon
- d) oxygen tank

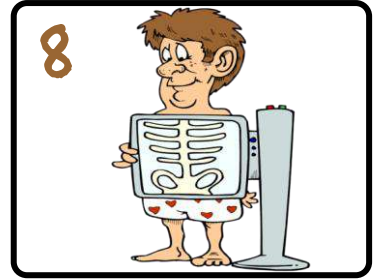

- a) hot water bottle
- b) ambulance
- c) x-ray
- d) doctor

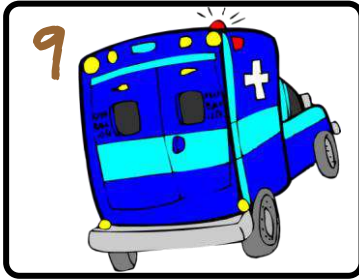

- a) ambulance
- b) hot water bottle
- c) surgeon
- d) x-ray



- a) examination
- b) stethoscope
- c) doctor
- d) wheelchair

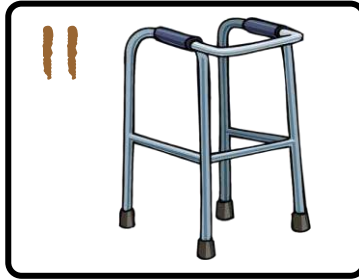

- a) oxygen tank
- b) dentist
- c) walker
- d) secretary

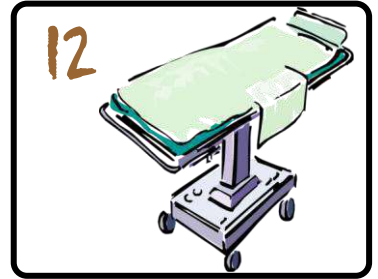

- a) patient
- b) stretcher
- c) test tube
- d) nurse

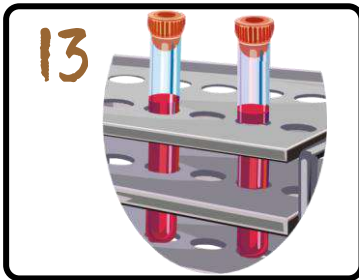

- a) test tube
- b) dentist
- c) examination
- d) walker

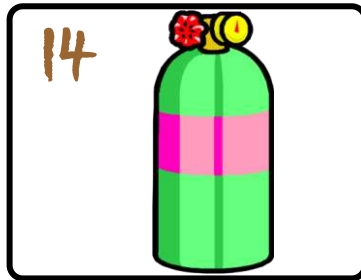

- a) patient
- b) stretcher
- c) oxygen tank
- d) surgeon



- a) x-ray
- b) doctor
- c) wheelchair
- d) hot water bottle



- a) nurse
- b) stethoscope
- c) secretary
- d) ambulance

AT THE HOSPITAL MULTIPLE CHOICE TEST 2

Look at the pictures, choose and circle the correct option.

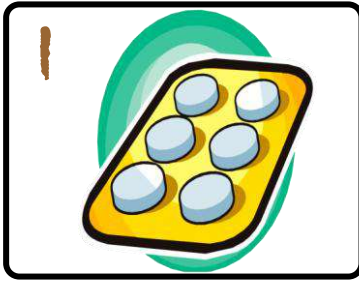

- a) tablets
- b) gloves
- c) oxygen mask
- d) syringe



- a) cream
- b) bed
- c) drop
- d) crutches

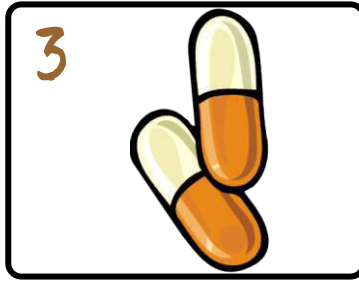

- a) capsules
- b) microscope
- c) thermometer
- d) mask

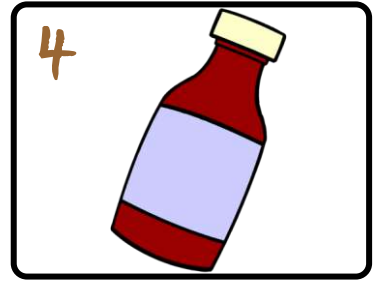

- a) cap
- b) blood pressure monitor
- c) drip
- d) syrup



- a) drip
- b) capsules
- c) cream
- d) microscope



- a) thermometer
- b) mask
- c) tablets
- d) oxygen mask

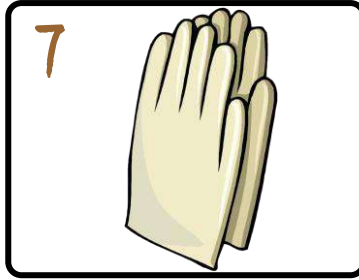

- a) drop
- b) syringe
- c) blood pressure monitor
- d) gloves

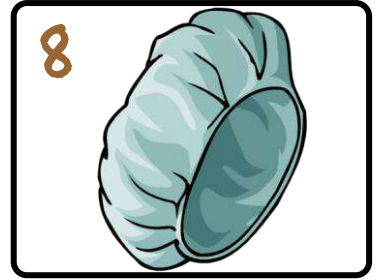

- a) bed
- b) cap
- c) syrup
- d) crutches



- a) blood pressure monitor
- b) syrup
- c) gloves
- d) syringe



- a) drip
- b) cream
- c) microscope
- d) capsules

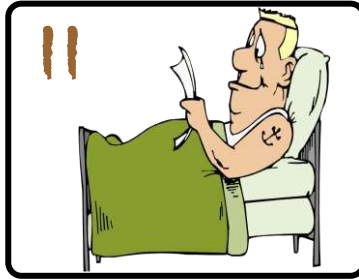

- a) drop
- b) crutches
- c) bed
- d) mask



- a) oxygen mask
- b) thermometer
- c) tablets
- d) cap

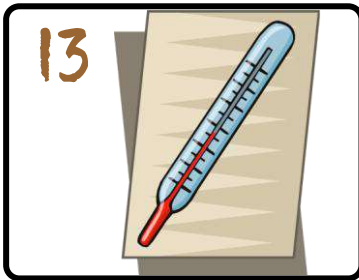

- a) microscope
- b) drop
- c) cap
- d) thermometer

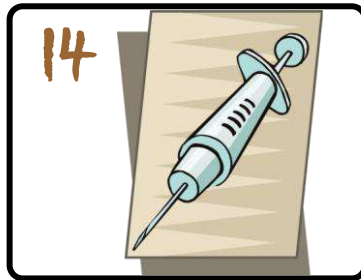

- a) bed
- b) syringe
- c) tablets
- d) cream

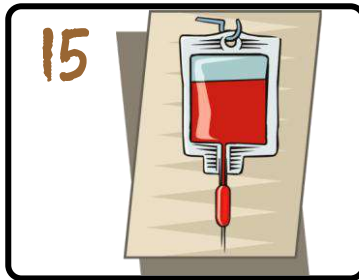

- a) mask
- b) oxygen mask
- c) syrup
- d) drip



- a) crutches
- b) capsules
- c) blood pressure monitor
- d) gloves

AT THE HOSPITAL MULTIPLE CHOICE TESTS ANSWER KEY

TEST 1

- 1) b
- 2) d
- 3) c
- 4) a
- 5) b
- 6) c
- 7) b
- 8) c
- 9) a
- 10) d
- 11) c
- 12) b
- 13) a
- 14) c
- 15) d
- 16) b

TEST 2

- 1) a
- 2) c
- 3) a
- 4) d
- 5) c
- 6) b
- 7) d
- 8) b
- 9) a
- 10) c
- 11) c
- 12) a
- 13) d
- 14) b
- 15) d
- 16) a



doctor



dentist



nurse



surgeon



patient



secretary

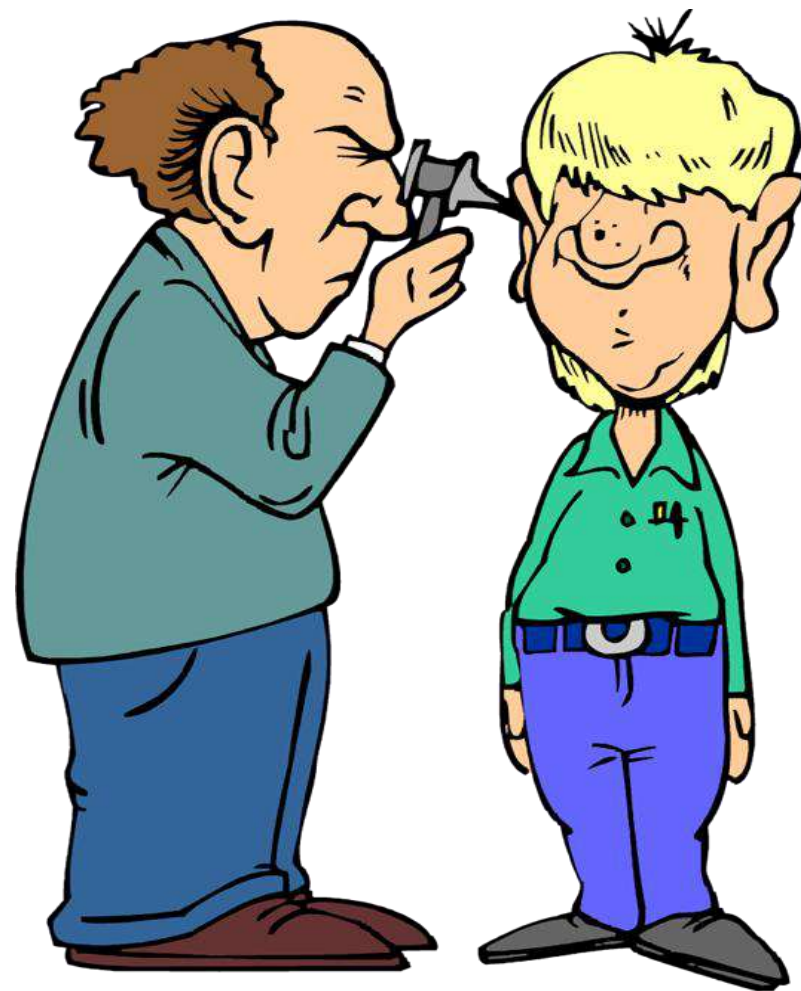

examination

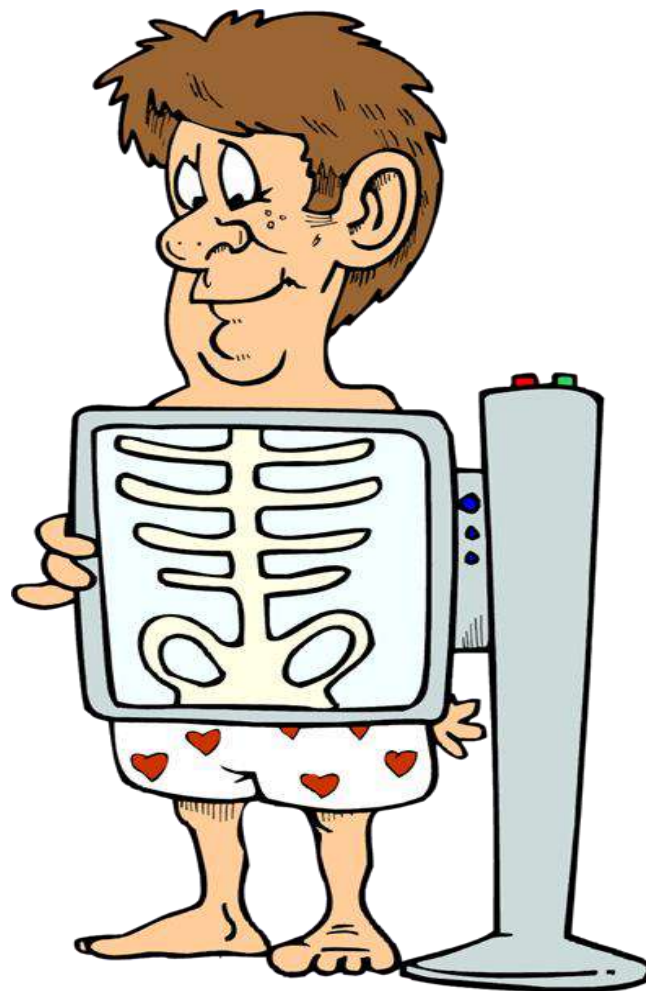

x-ray

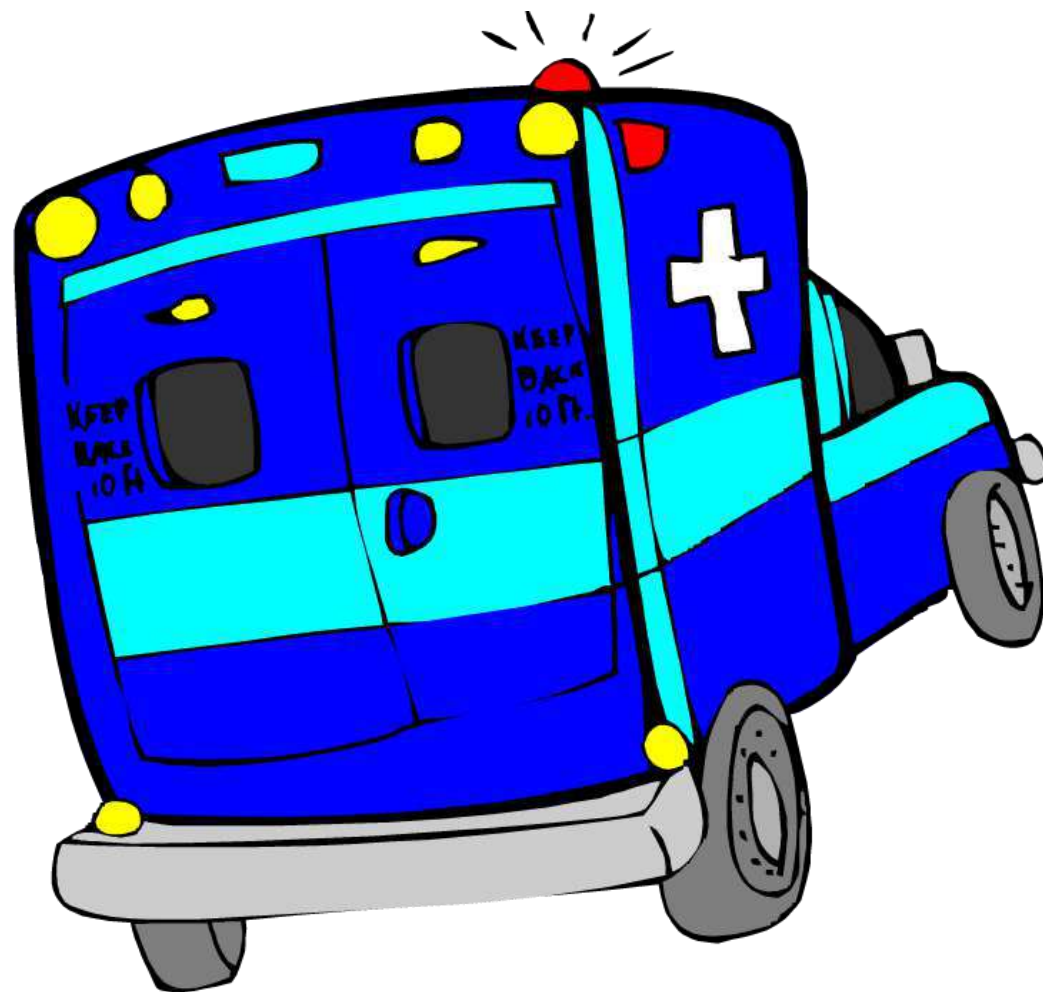

ambulance

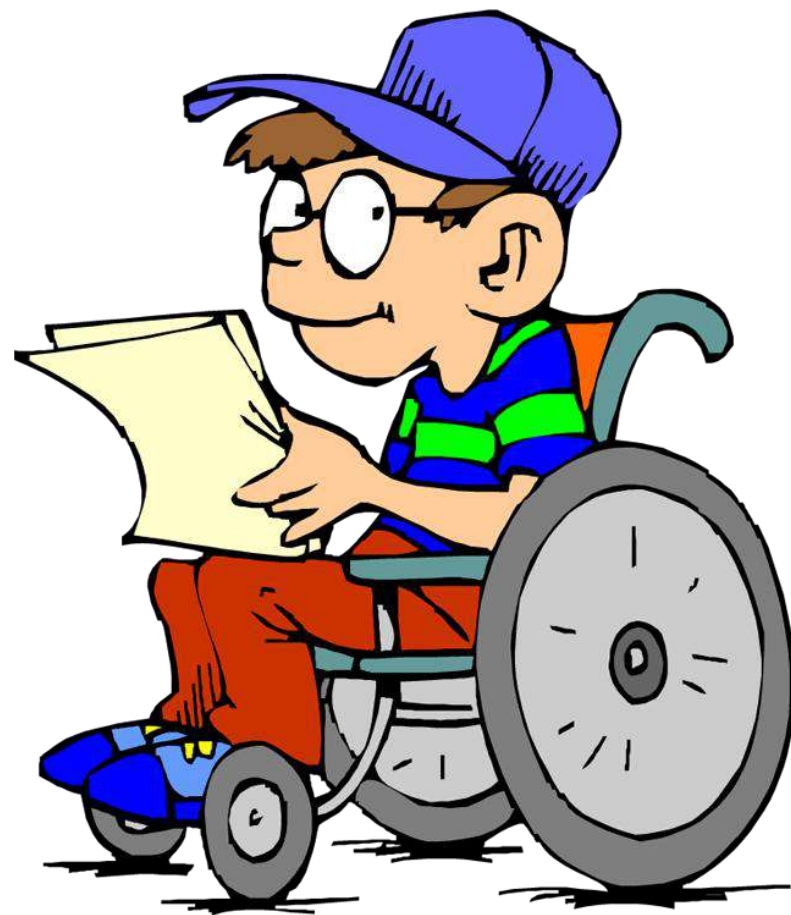

wheelchair

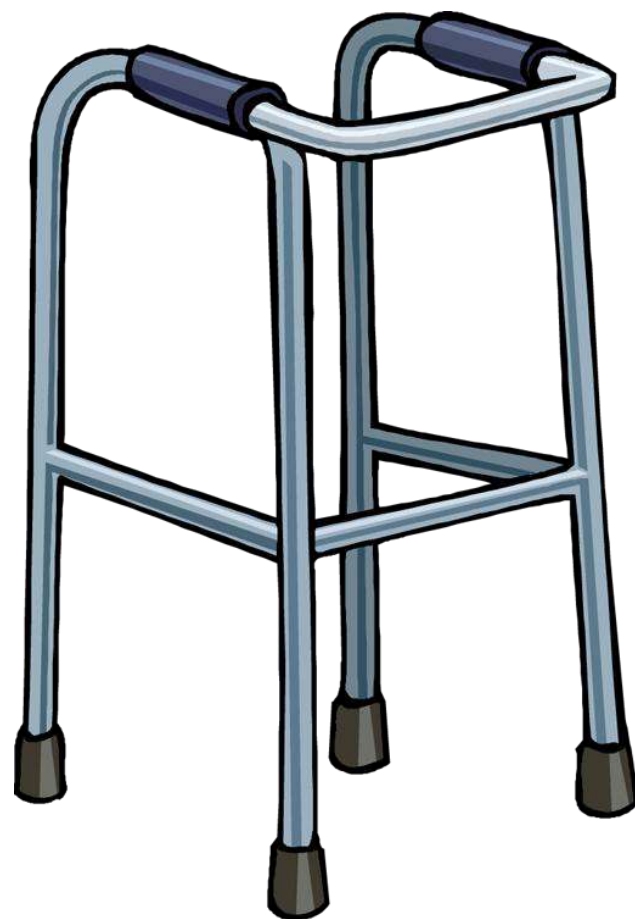

walker



stretcher

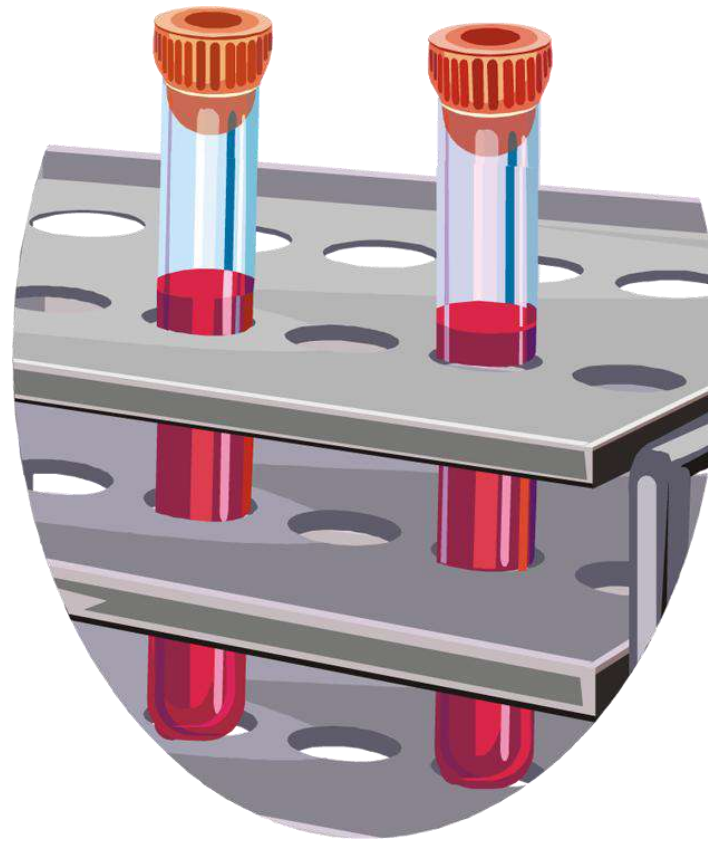

blood test

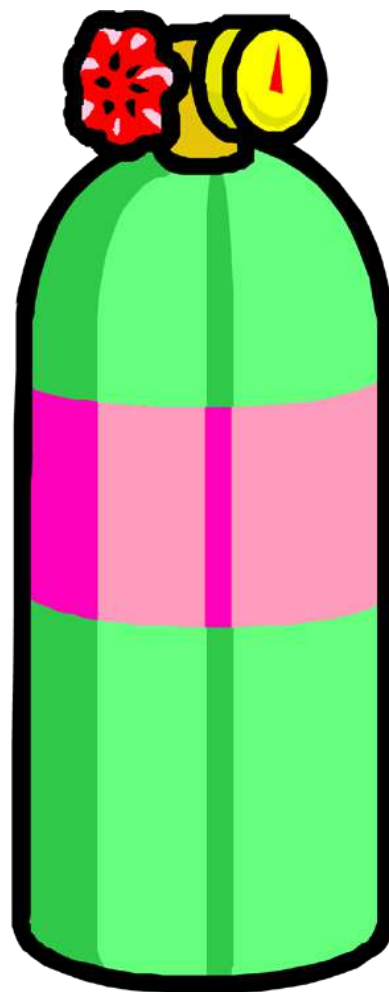

oxygen tank



hot water bottle



stethoscope



tablets



drop



capsules

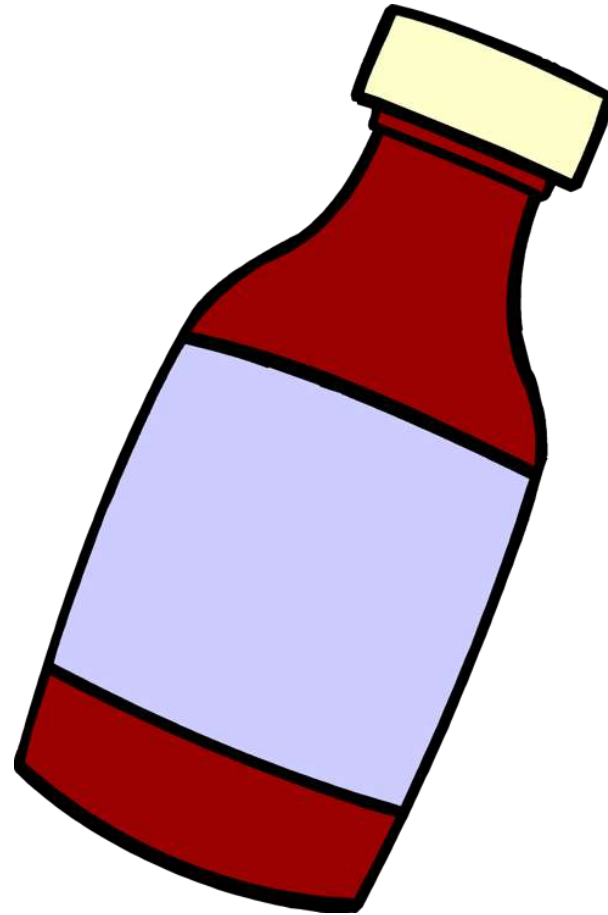

syrup

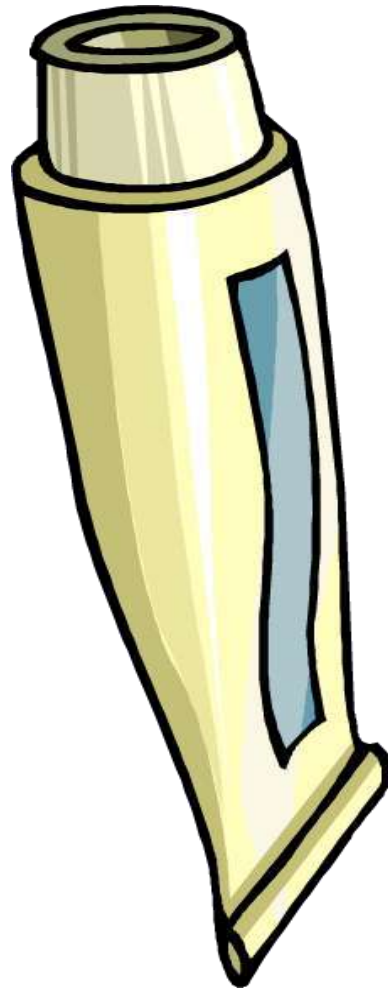

cream



mask

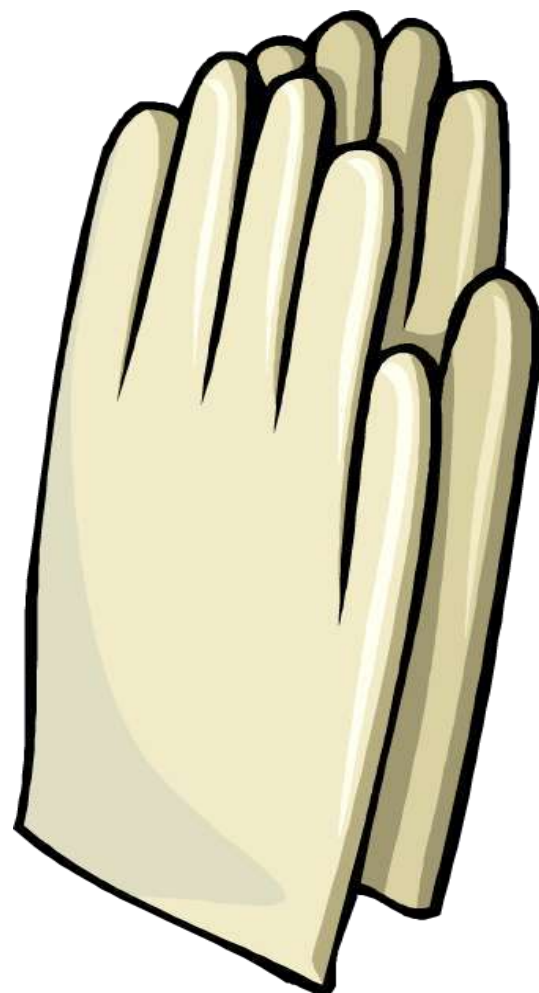

gloves



cap



blood pressure monitor



microscope



bed



oxygen mask

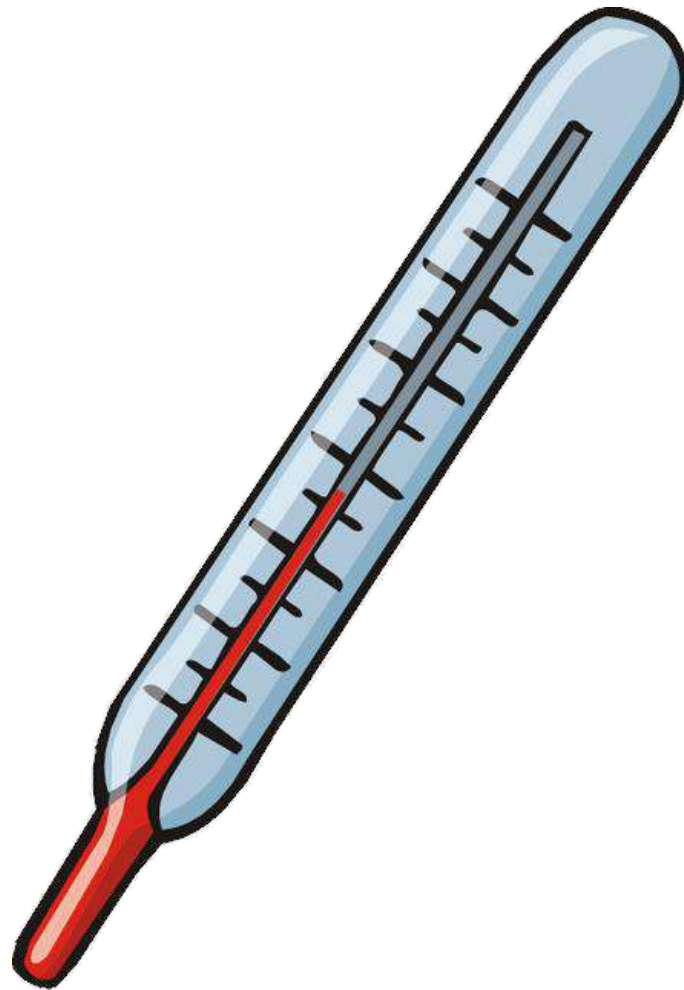

thermometer



syringe



drip



crutches













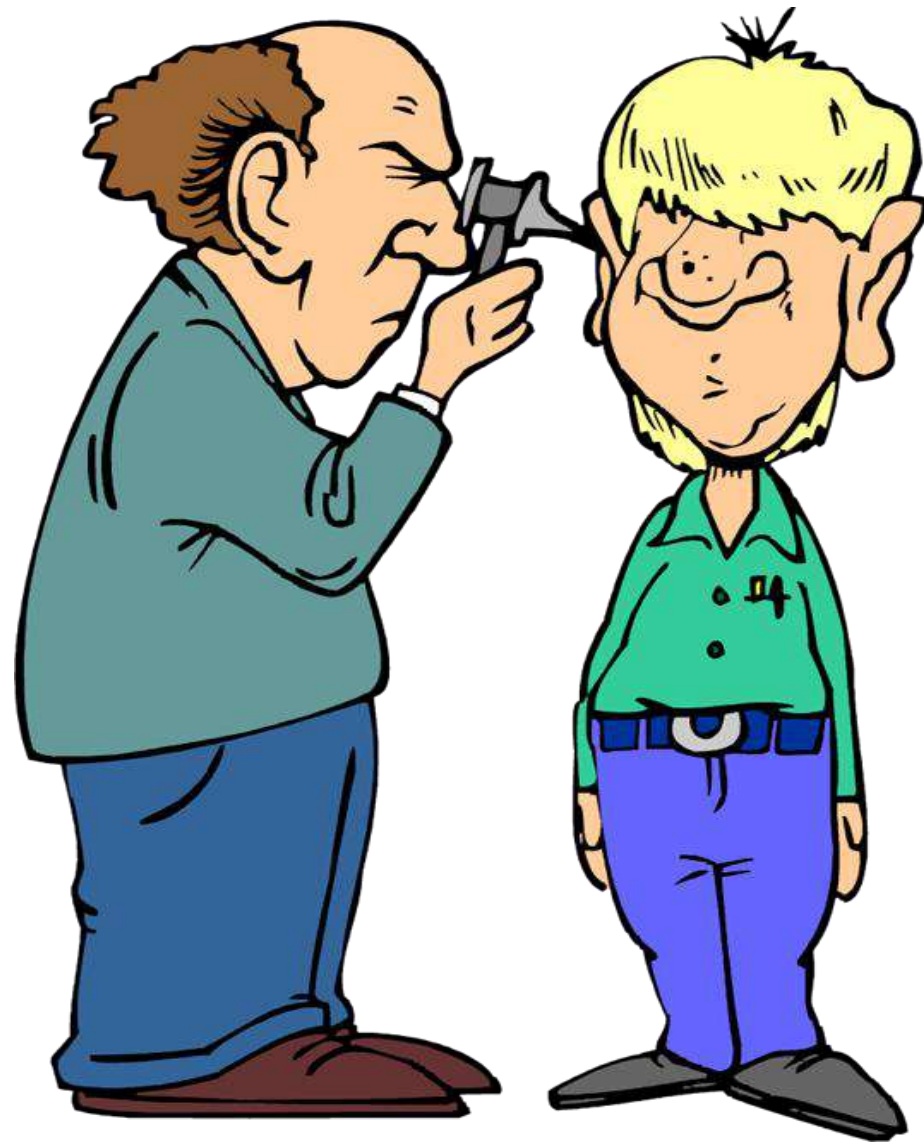

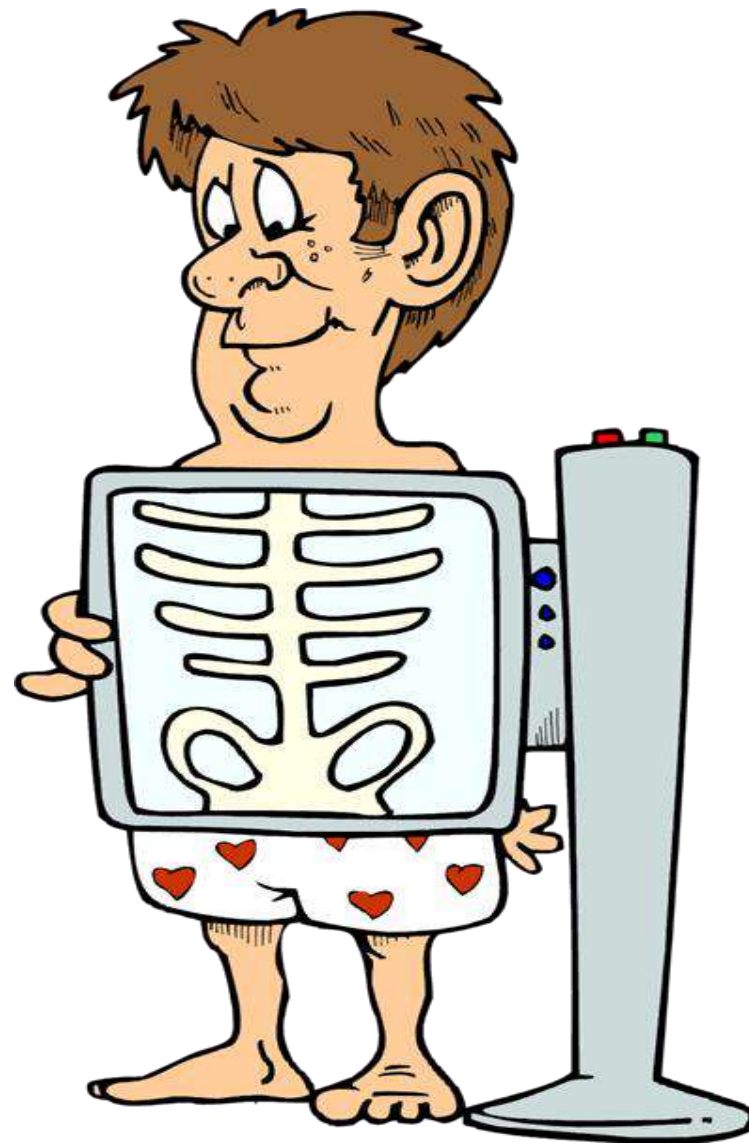

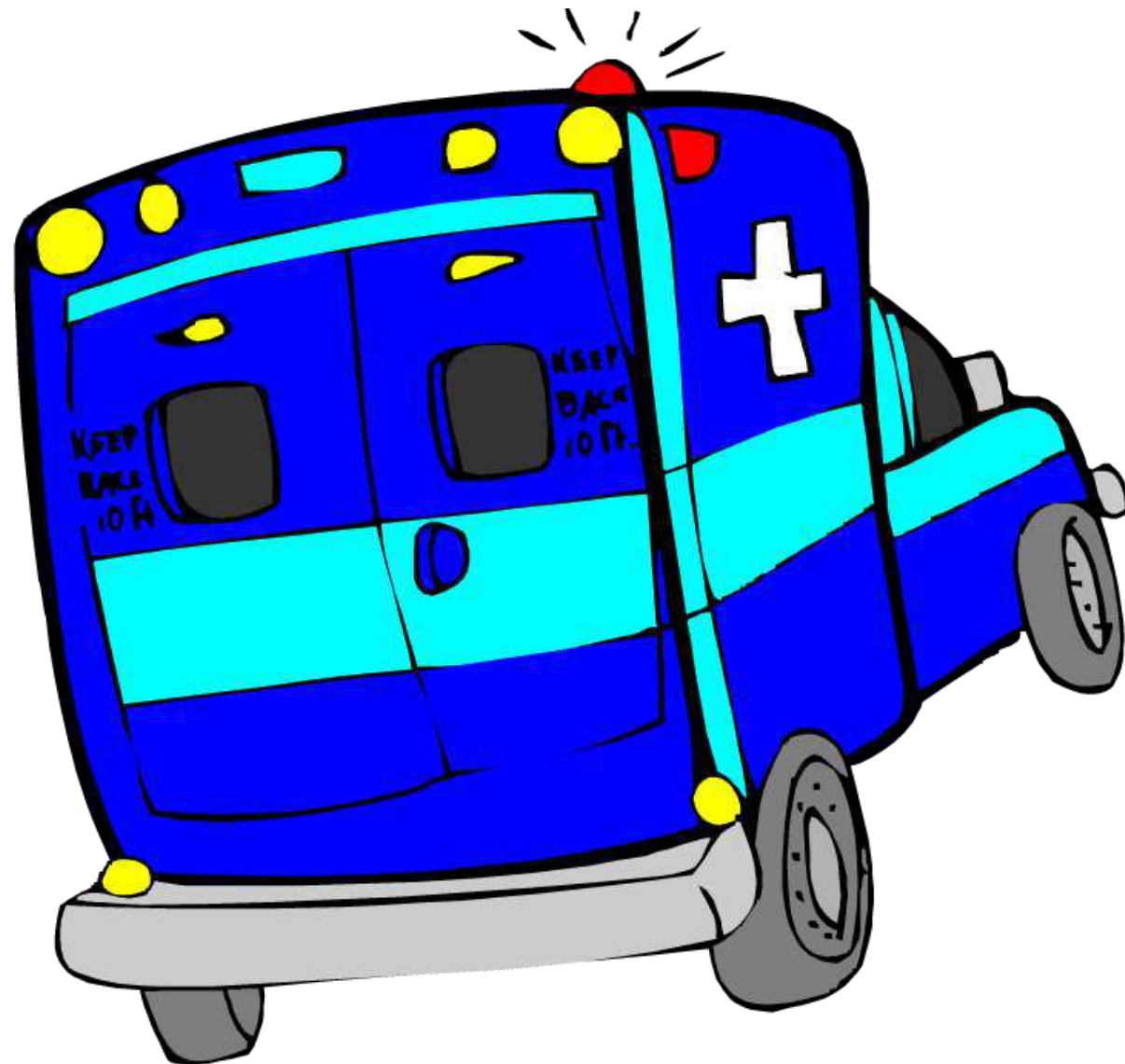



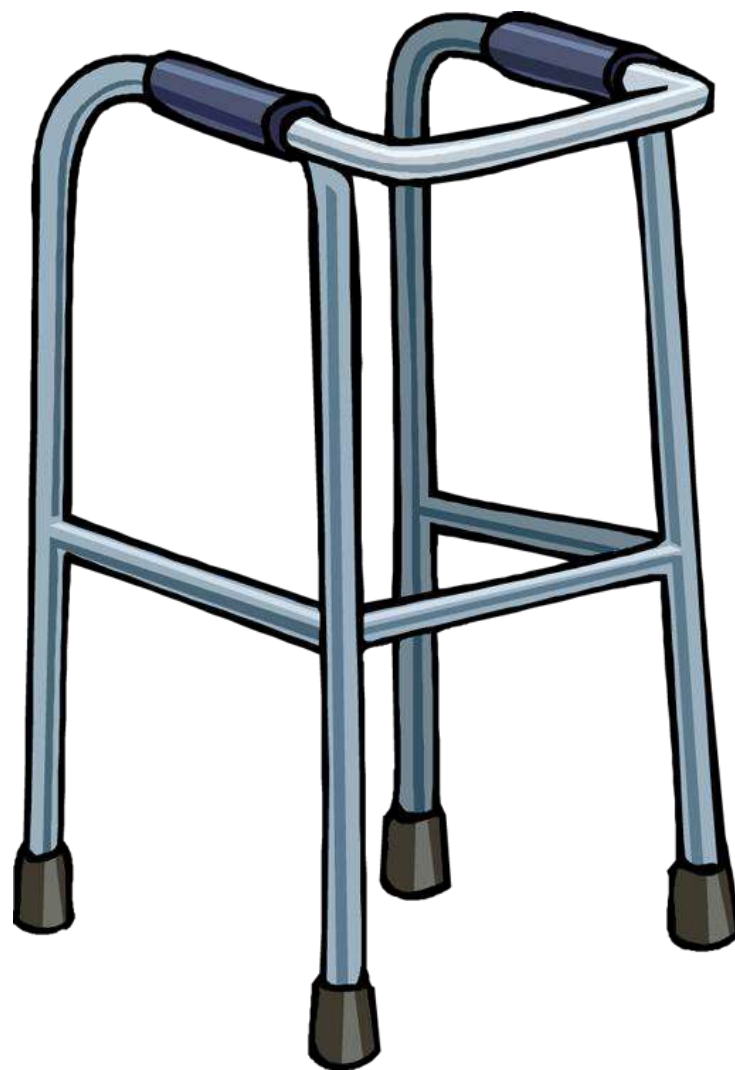



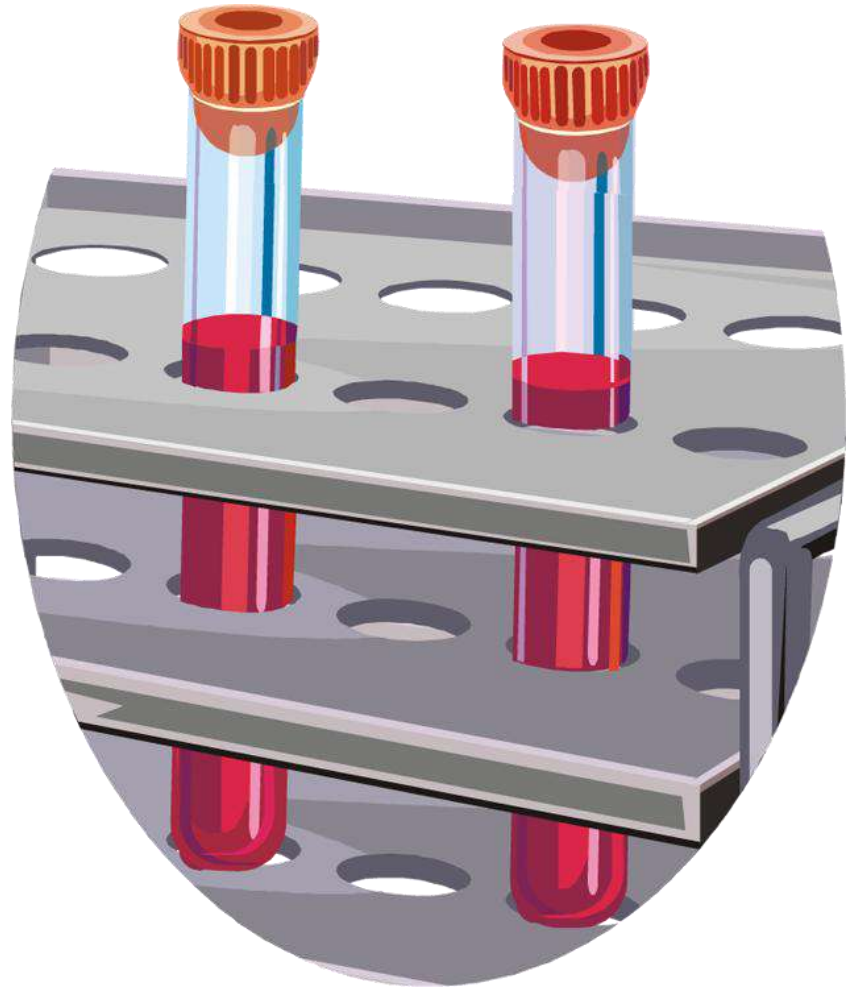

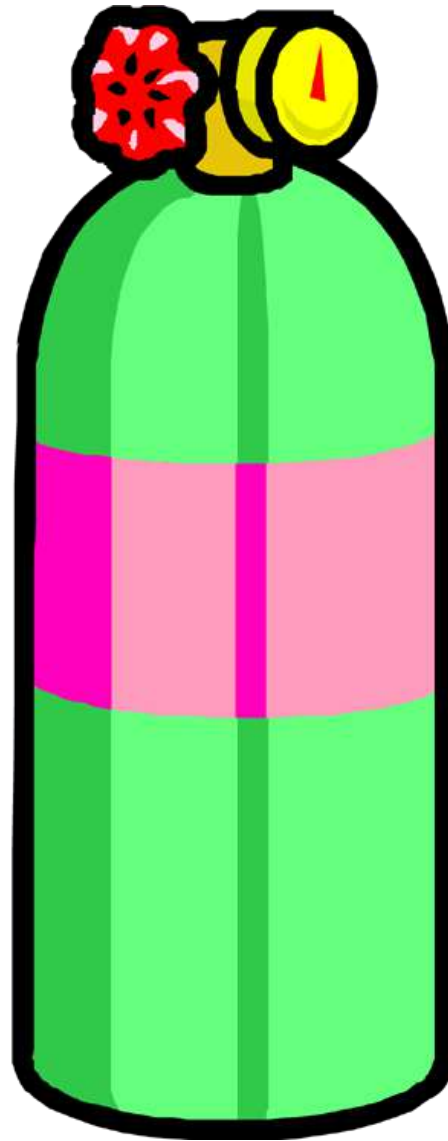









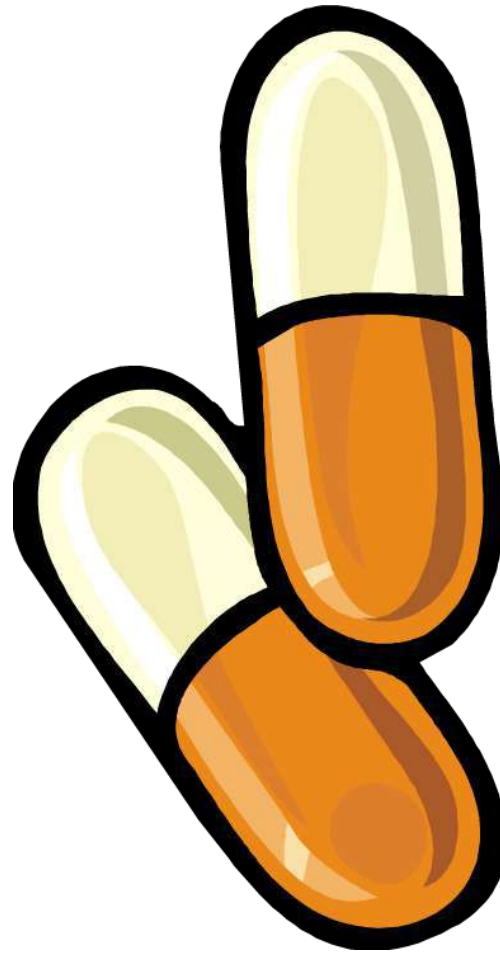

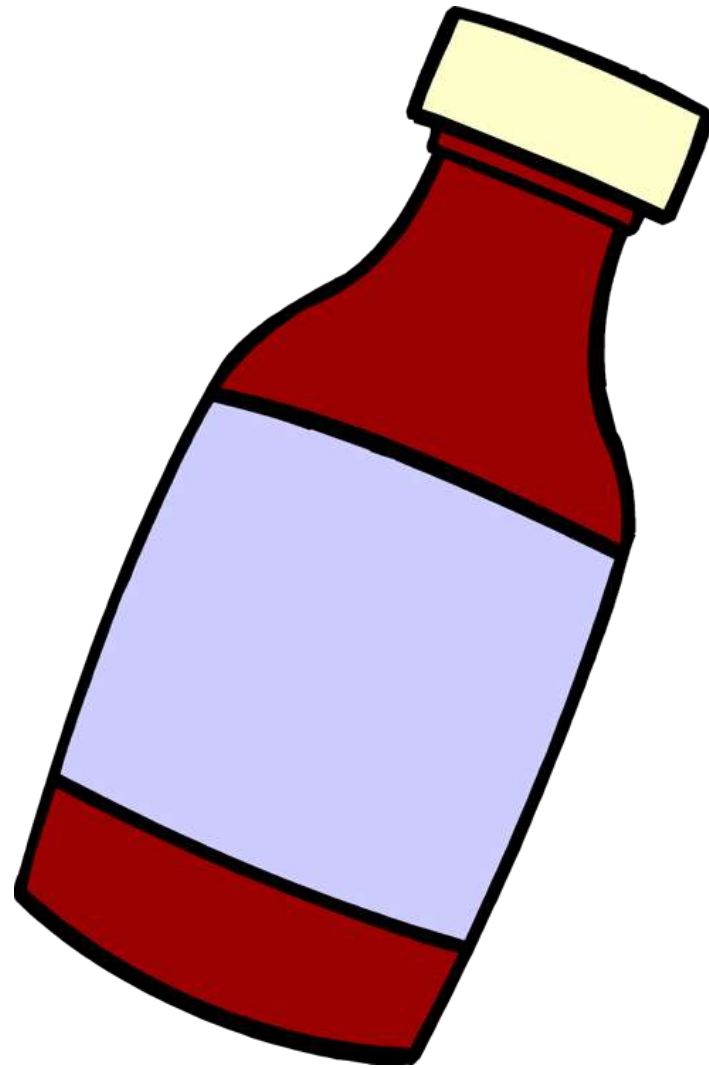

















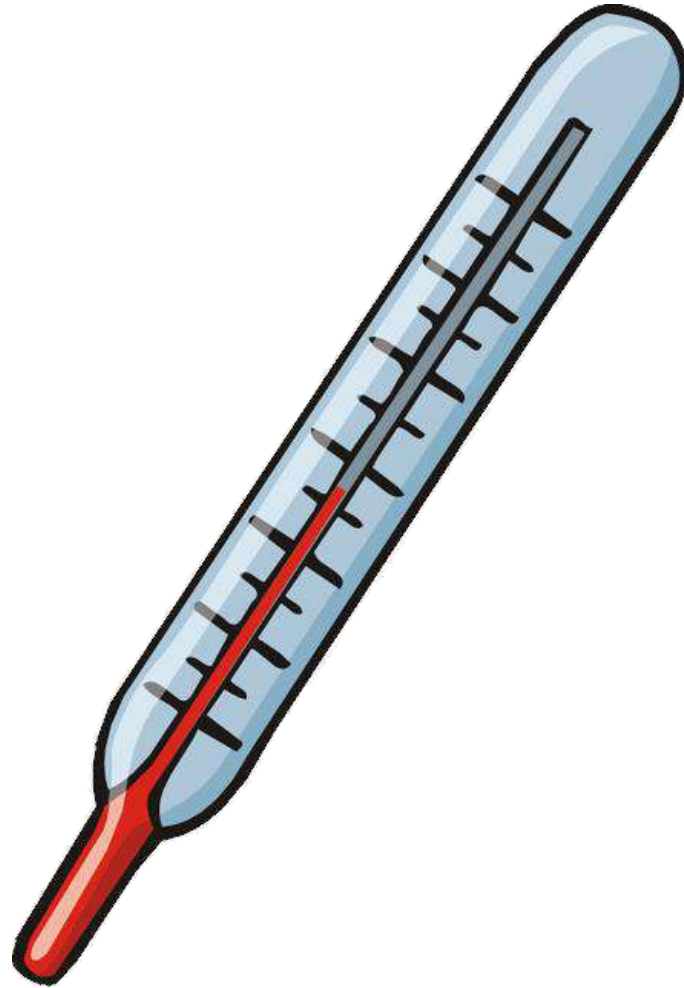









doctor

Copyright © 06/10/2019 englishsheets.com. All rights reserved.

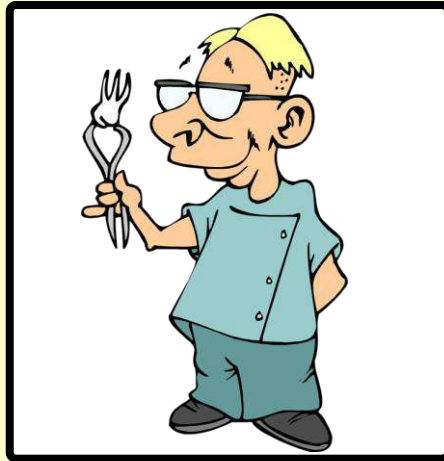

dentist

Copyright © 06/10/2019 englishsheets.com. All rights reserved.



nurse

Copyright © 06/10/2019 englishsheets.com. All rights reserved.



surgeon

Copyright © 06/10/2019 englishsheets.com. All rights reserved.



patient

Copyright © 06/10/2019 englishsheets.com. All rights reserved.



secretary

Copyright © 06/10/2019 englishsheets.com. All rights reserved.

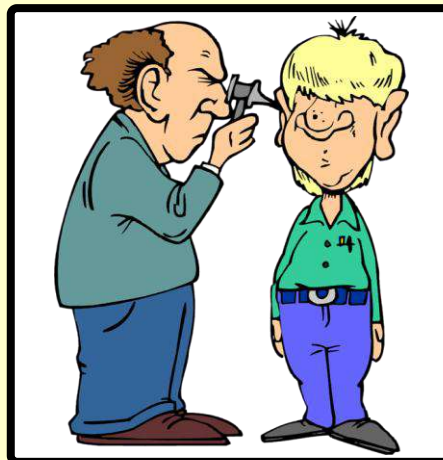

examination

Copyright © 06/10/2019 englishsheets.com. All rights reserved.

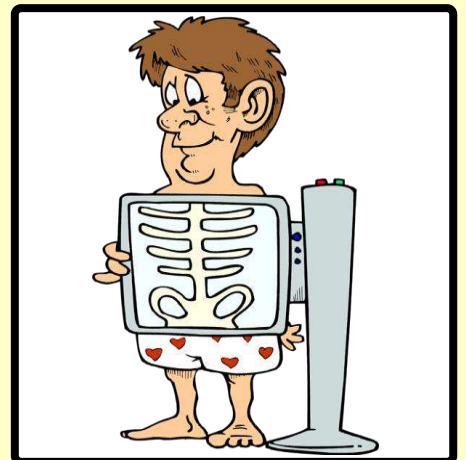

x-ray

Copyright © 06/10/2019 englishsheets.com. All rights reserved.



ambulance

Copyright © 06/10/2019 englishsheets.com. All rights reserved.



wheelchair

Copyright © 06/10/2019 englishsheets.com. All rights reserved.

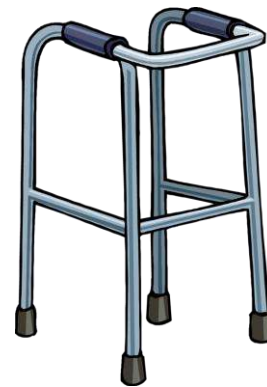

walker

Copyright © 06/10/2019 englishsheets.com. All rights reserved.



stretcher

Copyright © 06/10/2019 englishsheets.com. All rights reserved.

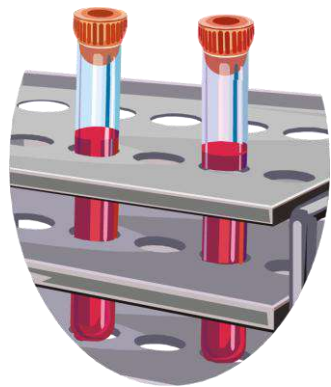

blood test

Copyright © 06/10/2019 englishsheets.com. All rights reserved.

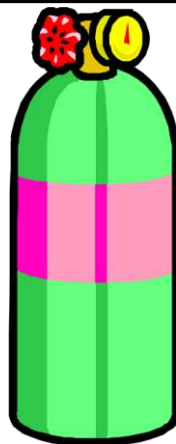

oxygen tank

Copyright © 06/10/2019 englishsheets.com. All rights reserved.



hot water bottle

Copyright © 06/10/2019 englishsheets.com. All rights reserved.



stethoscope

Copyright © 06/10/2019 englishsheets.com. All rights reserved.



tablets

Copyright © 06/10/2019 englishsheets.com. All rights reserved.



drop

Copyright © 06/10/2019 englishsheets.com. All rights reserved.



capsules

Copyright © 06/10/2019 englishsheets.com. All rights reserved.

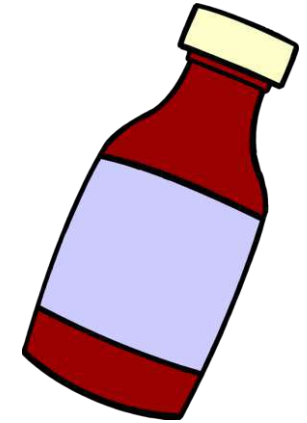

syrup

Copyright © 06/10/2019 englishsheets.com. All rights reserved.



cream

Copyright © 06/10/2019 englishsheets.com. All rights reserved.

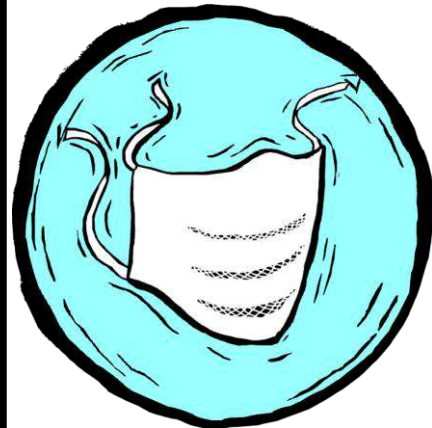

mask

Copyright © 06/10/2019 englishsheets.com. All rights reserved.



gloves

Copyright © 06/10/2019 englishsheets.com. All rights reserved.



cap

Copyright © 06/10/2019 englishsheets.com. All rights reserved.



blood pressure
monitor

Copyright © 06/10/2019 englishsheets.com. All rights reserved.



microscope

Copyright © 06/10/2019 englishsheets.com. All rights reserved.



bed

Copyright © 06/10/2019 englishsheets.com. All rights reserved.



oxygen mask

Copyright © 06/10/2019 englishsheets.com. All rights reserved.

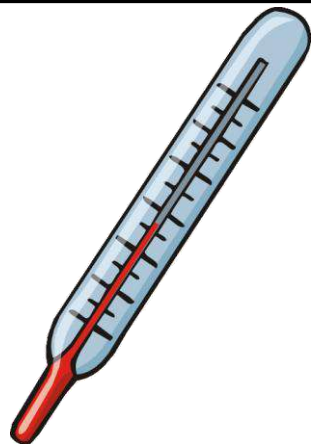

thermometer

Copyright © 06/10/2019 englishsheets.com. All rights reserved.



syringe

Copyright © 06/10/2019 englishsheets.com. All rights reserved.

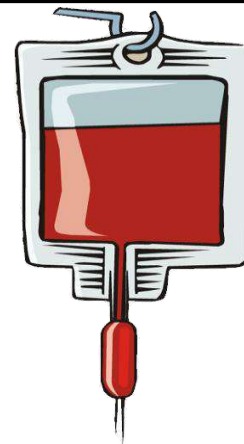

drip

Copyright © 06/10/2019 englishsheets.com. All rights reserved.



crutches

Copyright © 06/10/2019 englishsheets.com. All rights reserved.

HOSPITAL FIDGET SPINNER GAME



- Cut a small arrow from paper or craft foam and stick it onto the fidget spinner as your pointer.
- Place the fidget spinner in the middle of the vocabulary circle.
- Spin it and say the word quickly!

HOSPITAL FIDGET SPINNER GAME



- Cut a small arrow from paper or craft foam and stick it onto the fidget spinner as your pointer.
- Place the fidget spinner in the middle of the vocabulary circle.
- Spin it and say the word quickly!

HOSPITAL FIDGET SPINNER GAME



- Cut a small arrow from paper or craft foam and stick it onto the fidget spinner as your pointer.
- Place the fidget spinner in the middle of the vocabulary circle.
- Spin it and say the word quickly!

HOSPITAL FIDGET SPINNER GAME



- Cut a small arrow from paper or craft foam and stick it onto the fidget spinner as your pointer.
- Place the fidget spinner in the middle of the vocabulary circle.
- Spin it and say the word quickly!

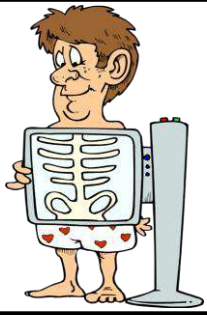

doctor

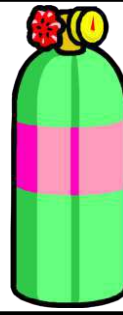

dentist



nurse



surgeon



patient

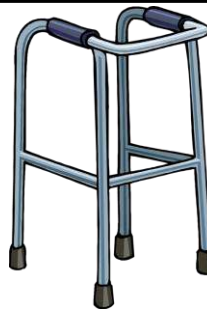

secretary



examination



x-ray

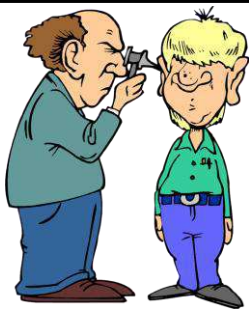

ambulance

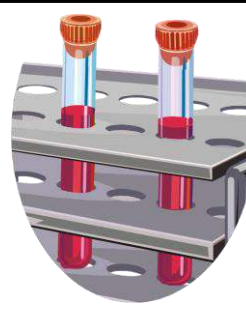

wheelchair



walker



stretcher



blood test



oxygen tank



hot water
bottle



stethoscope



tablets

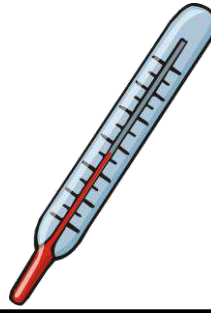

drop



capsules



syrup



cream



mask



gloves



cap



blood pressure
monitor



microscope



bed



oxygen mask



thermometer



syringe



drip



crutches

AT THE HOTEL PICTURE DICTIONARY !



reception



bellboy



maid



manager



luggage



key

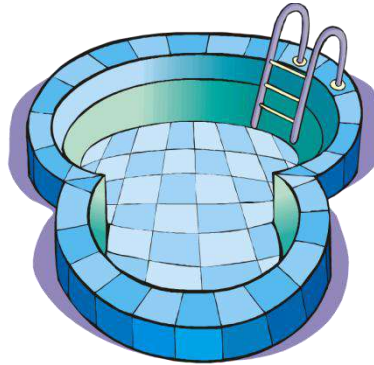

swimming pool

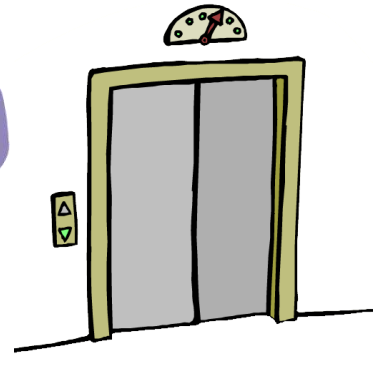

lift



air conditioner



sauna

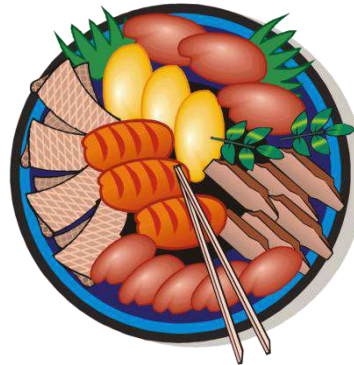

buffet



gym

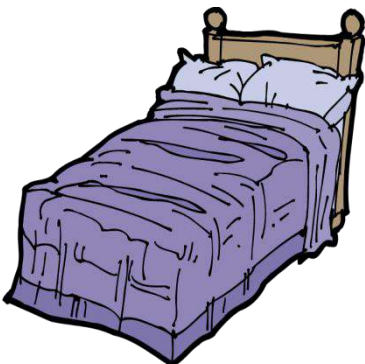

double bed

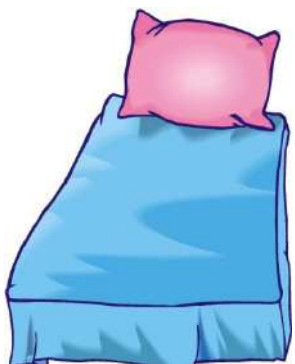

single bed

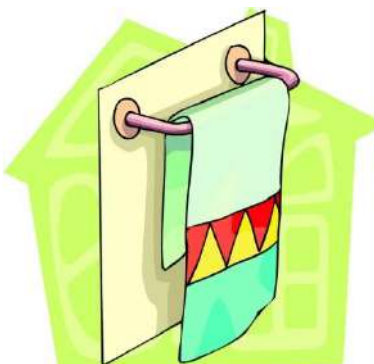

towel

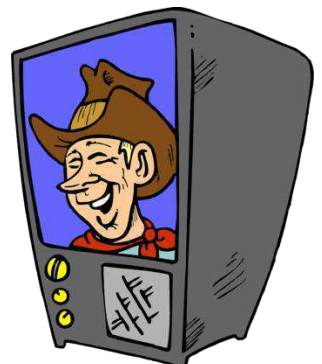

television

AT THE HOTEL PICTURE DICTIONARY 2



lobby

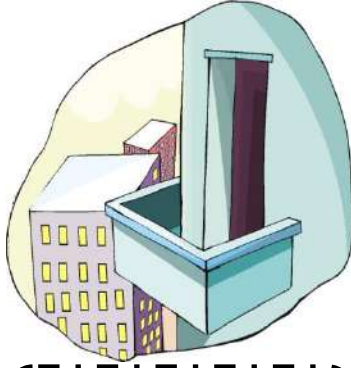

balcony

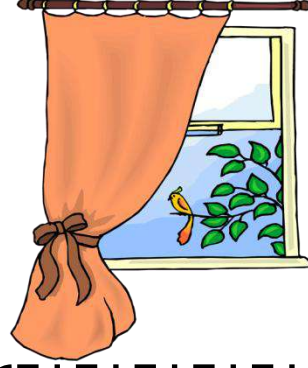

view



brochure



credit card



internet connection

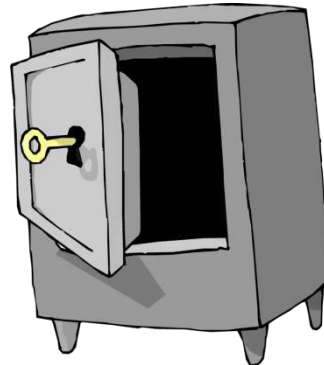

safe



laundry



tip

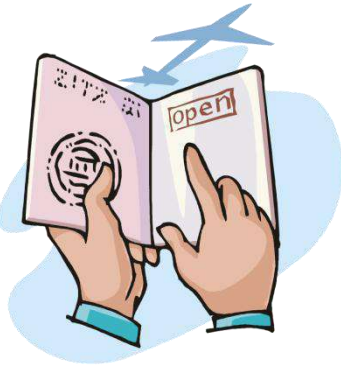

passport

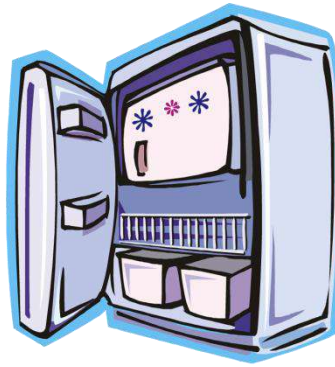

minibar



bathtub



hair dryer



fan



vending machine



spa

AT THE HOTEL PICTURE DICTIONARY !



reception



bellboy



maid



manager



luggage



key



swimming pool



lift



air conditioner



sauna

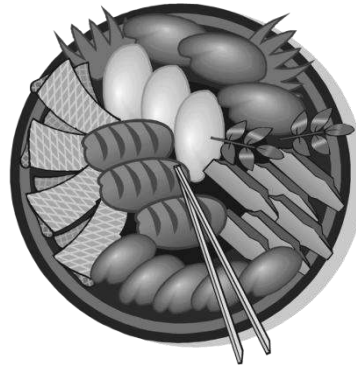

buffet



gym



double bed



single bed

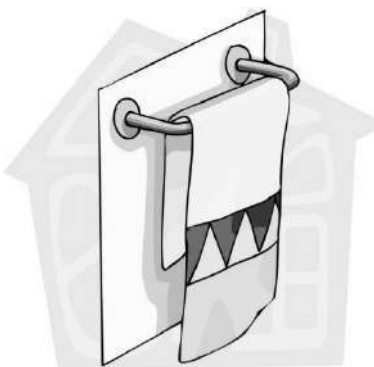

towel



television

AT THE HOTEL PICTURE DICTIONARY 2



lobby

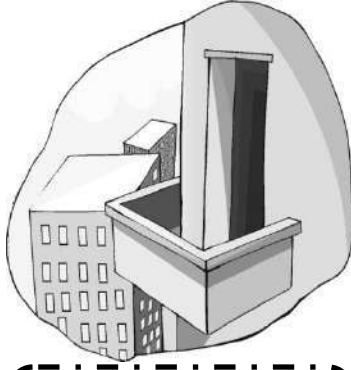

balcony



view



brochure



credit card



internet connection

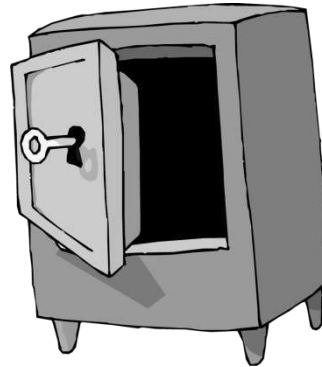

safe



laundry



tip

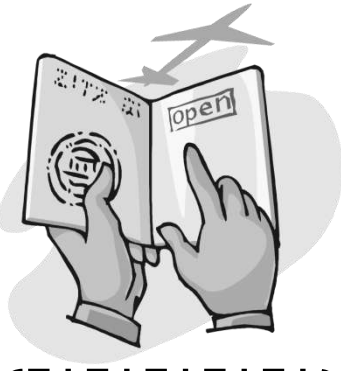

passport

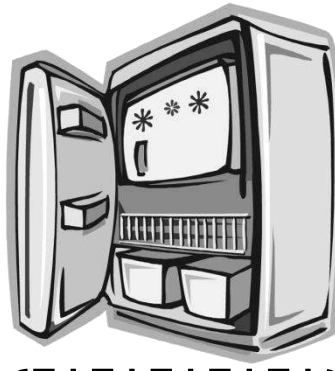

minibar



bathtub



hair dryer



fan



vending machine



spa

AT THE HOTEL VOCABULARY MATCHING WORKSHEET !

Choose the correct words from the list below and write them under the correct pictures

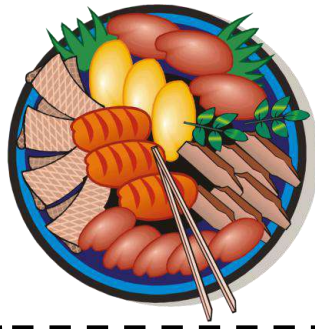



WORD LIST

- reception
- bellboy
- maid
- manager
- luggage
- key
- swimming pool
- lift
- air conditioner
- sauna
- buffet
- gym
- double bed
- single bed
- towel
- television



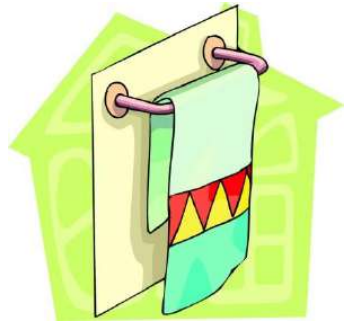

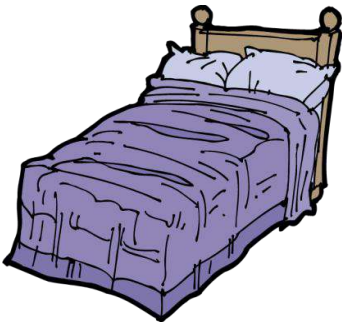

AT THE HOTEL VOCABULARY MATCHING WORKSHEET 2

Choose the correct words from the list below and write them under the correct pictures



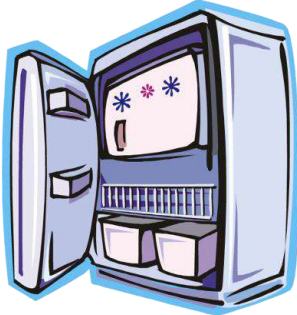

WORD LIST

- lobby
- balcony
- view
- brochure
- credit card
- internet connection
- safe
- laundry
- tip
- passport
- minibar
- bathtub
- hair dryer
- fan
- vending machine
- spa

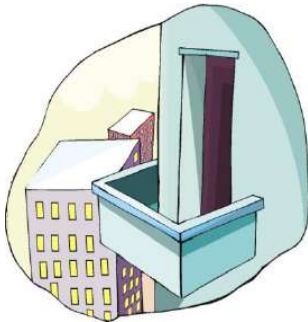

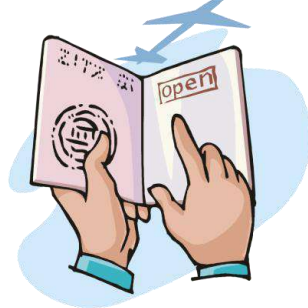

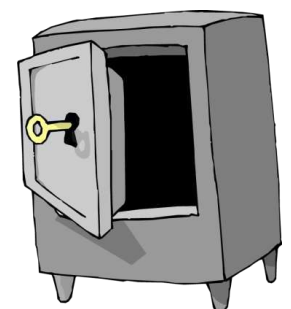

AT THE HOTEL VOCABULARY MATCHING WORKSHEET 1 ANSWER KEY

Choose the correct words from the list below and write them under the correct pictures



manager

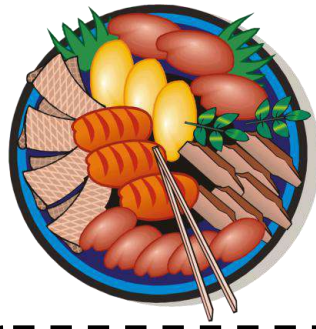

buffet



swimming pool



television



air conditioner



single bed

WORD LIST

- reception
- bellboy
- maid
- manager
- luggage
- key
- swimming pool
- lift
- air conditioner
- sauna
- buffet
- gym
- double bed
- single bed
- towel
- television



key



reception



sauna



towel



bellboy



lift

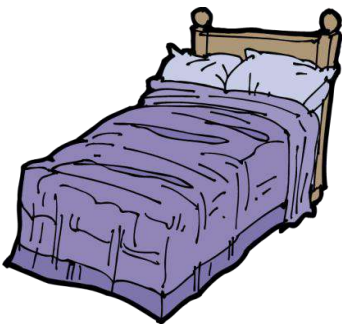

double bed



maid



gym



luggage

AT THE HOTEL VOCABULARY MATCHING WORKSHEET 2 ANSWER KEY

Choose the correct words from the list below and write them under the correct pictures



bathtub



brochure



internet connection



hair dryer

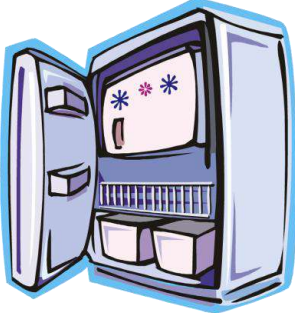

minibar



laundry

WORD LIST

- lobby
- balcony
- view
- brochure
- credit card
- internet connection
- safe
- laundry
- tip
- passport
- minibar
- bathtub
- hair dryer
- fan
- vending machine
- spa

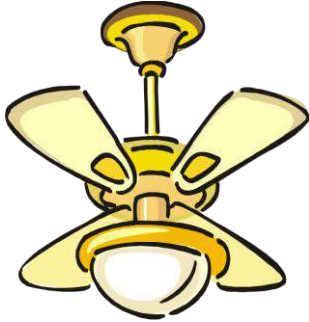

fan

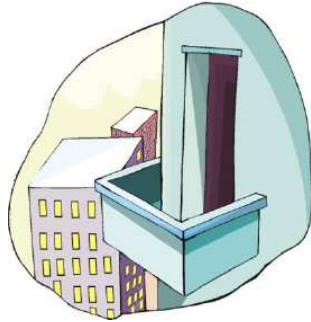

balcony



credit card

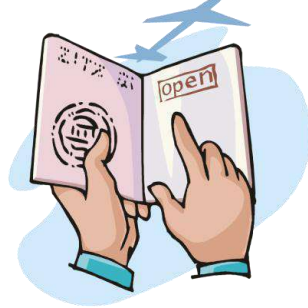

passport



view



spa



tip



lobby

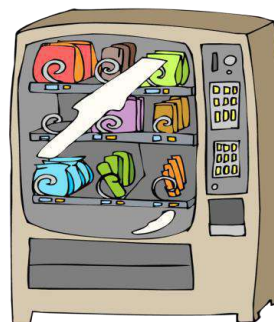

vending machine

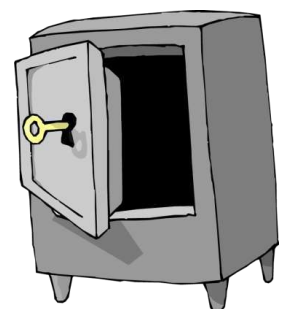

safe

AT THE HOTEL VOCABULARY WORD SEARCH PUZZLE !

Find and circle the words in the word search puzzle and number the pictures

d	a	i	r	c	o	n	d	i	t	i	o	n	e	r
l	o	k	e	y	d	o	u	b	l	e	b	e	d	g
e	y	t	c	n	e	b	z	e	u	x	g	y	m	b
s	h	o	e	i	q	w	c	l	g	l	b	p	p	u
i	f	w	p	b	t	v	b	l	g	b	e	y	d	f
n	q	e	t	e	e	e	h	b	a	u	e	k	o	f
g	l	i	x	h	e	v	o	g	w	k	o	m	e	
l	i	v	o	c	h	n	y	e	m	o	b	m	t	
e	f	e	n	d	m	a	n	a	g	e	r	u	g	b
b	t	q	f	t	e	l	e	v	i	s	i	o	n	l
e	g	u	d	l	b	w	q	w	s	a	u	n	a	z
d	w	q	n	z	e	y	t	s	j	z	f	g	u	k
m	t	s	w	i	m	m	i	n	g	p	o	o	l	m
x	d	e	u	c	c	e	s	n	n	x	a	o	f	k
p	f	n	d	n	f	o	g	x	y	m	a	i	d	b

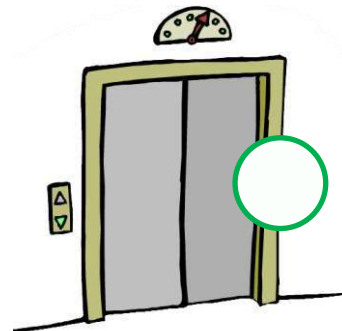
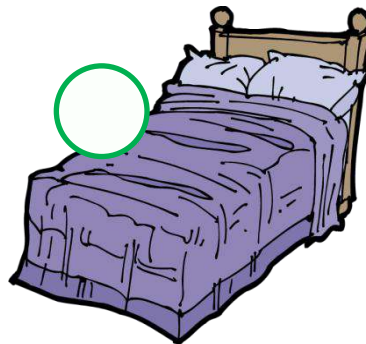
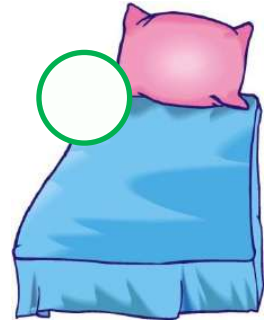
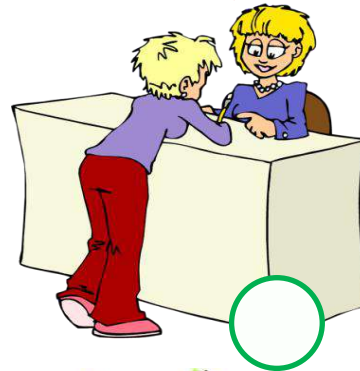
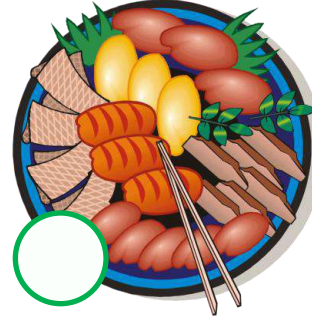
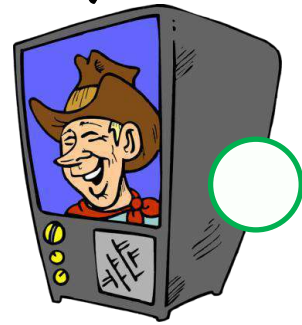
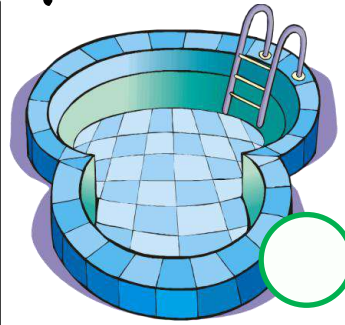

1. reception
2. bellboy
3. maid
4. manager
5. luggage
6. key
7. swimming pool
8. lift
9. air conditioner
10. sauna
11. buffet
12. gym
13. double bed
14. single bed
15. towel
16. television

AT THE HOTEL VOCABULARY WORD SEARCH PUZZLE 2

Find and circle the words in the word search puzzle and number the pictures

t	h	a	i	r	d	r	y	e	r	f	x	c	z	c	x	a	r
a	a	m	n	o	q	h	y	j	b	u	r	v	c	p	e	m	b
g	u	q	t	c	t	r	o	w	a	p	a	s	s	p	o	r	t
d	v	r	e	k	a	w	d	b	a	l	c	o	n	y	s	d	s
g	k	p	r	w	r	g	u	s	a	f	e	o	a	l	r	w	l
d	v	e	n	d	i	n	g	m	a	c	h	i	n	e	u	b	a
n	c	r	e	d	i	t	c	a	r	d	i	v	o	j	u	b	u
l	v	k	t	l	o	b	b	y	b	o	q	i	w	d	u	o	n
j	i	q	c	j	p	c	r	b	d	f	j	e	p	n	y	f	d
b	v	b	o	e	o	s	i	r	v	p	i	w	m	t	k	j	r
t	e	e	n	q	w	p	x	o	t	f	i	t	l	v	x	j	y
y	m	i	n	i	b	a	r	c	s	k	l	g	r	l	n	h	d
o	w	u	e	f	a	n	w	h	n	s	b	i	f	a	r	e	t
r	l	d	c	k	t	w	e	u	w	g	s	y	a	z	a	u	i
s	o	y	t	s	h	t	t	r	a	b	m	h	q	i	e	s	p
c	a	y	i	a	t	i	m	e	p	j	d	a	l	k	l	p	v
d	i	q	o	b	u	k	y	p	h	z	u	w	l	v	f	y	b
v	a	p	n	o	b	n	c	e	x	p	b	v	y	w	f	u	q

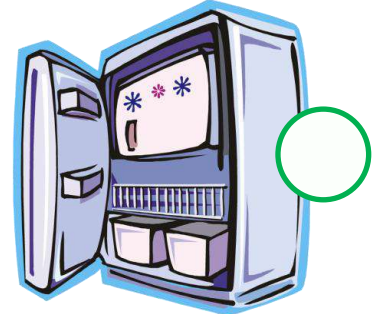
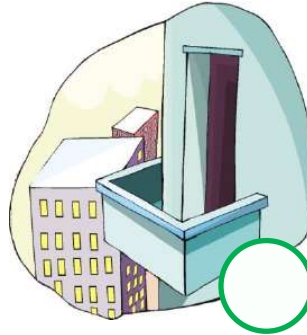
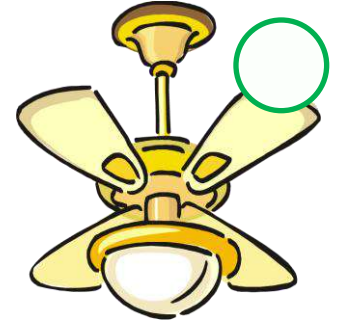
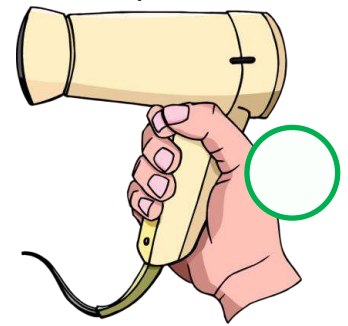

1. lobby
2. balcony
3. view
4. brochure
5. credit card
6. internet connection
7. safe
8. laundry
9. tip
10. passport
11. minibar
12. bathtub
13. hair dryer
14. fan
15. vending machine
16. spa

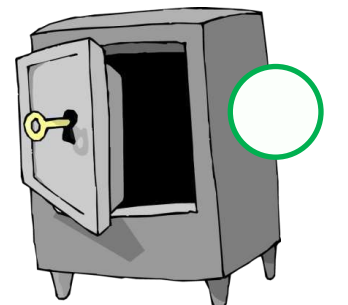
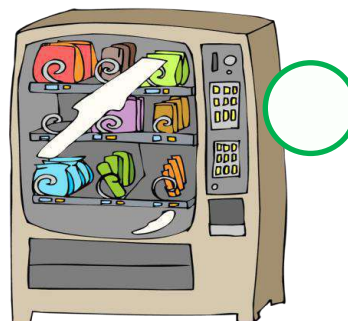
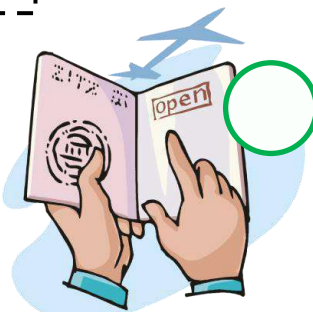

AT THE HOTEL VOCABULARY WORD SEARCH PUZZLE | ANSWER KEY

Find and circle the words in the word search puzzle and number the pictures

d	a	i	r	c	o	n	d	i	t	i	o	n	e	r
l	o	k	e	y	d	o	u	b	l	e	b	e	d	g
e	y	t	c	n	e	b	z	e	u	x	g	y	m	b
s	h	o	e	i	q	w	c	l	g	l	b	p	p	u
i	f	w	p	b	t	v	b	l	g	b	e	y	d	f
n	q	e	t	e	e	e	h	b	a	u	e	k	o	f
g	l	i	x	h	e	v	o	g	w	k	o	m	e	
l	i	v	o	c	h	n	y	e	m	o	b	m	t	
e	f	e	n	d	m	a	n	a	g	e	r	u	g	b
b	t	q	f	t	e	l	e	v	i	s	i	o	n	l
e	g	u	d	l	b	w	q	w	s	a	u	n	a	z
d	w	q	n	z	e	y	t	s	j	z	f	g	u	k
m	t	s	w	i	m	m	i	n	g	p	o	o	l	m
x	d	e	u	c	c	e	s	n	n	x	a	o	f	k
p	f	n	d	n	f	o	g	x	y	m	a	i	d	b

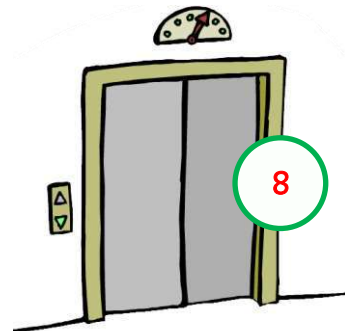
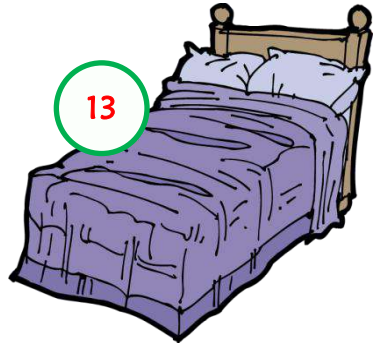
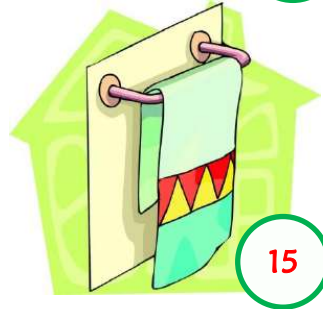
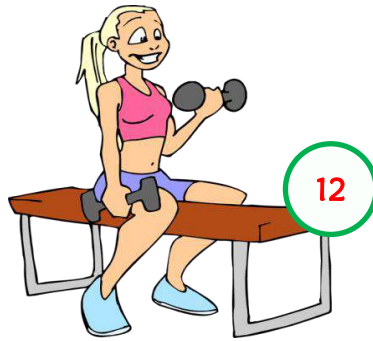
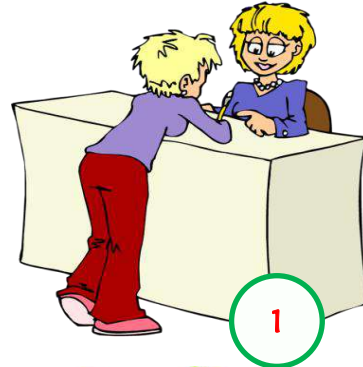
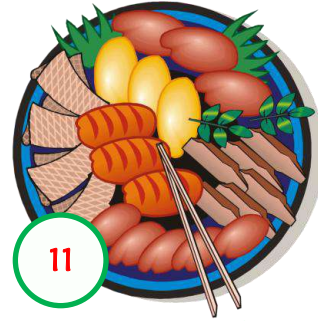
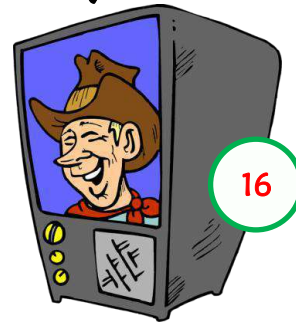
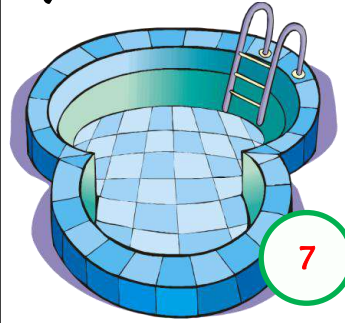

1. reception
2. bellboy
3. maid
4. manager
5. luggage
6. key
7. swimming pool
8. lift
9. air conditioner
10. sauna
11. buffet
12. gym
13. double bed
14. single bed
15. towel
16. television



AT THE HOTEL VOCABULARY WORD SEARCH PUZZLE 2 ANSWER KEY

Find and circle the words in the word search puzzle and number the pictures

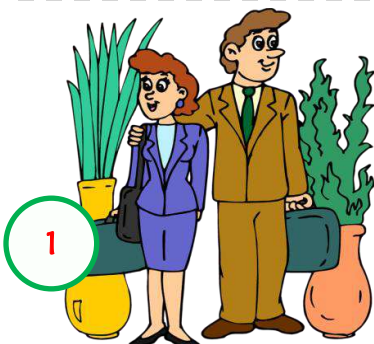
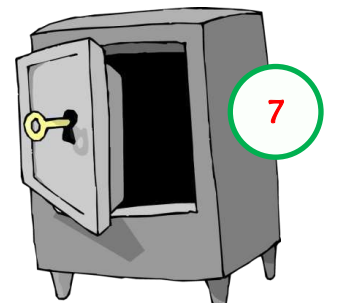
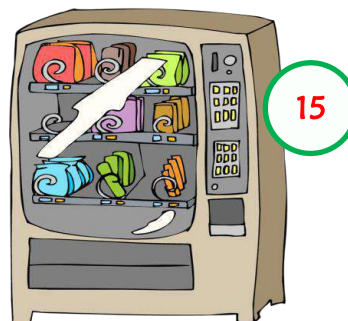
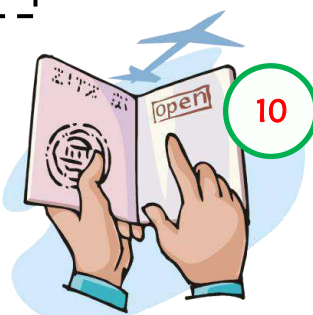
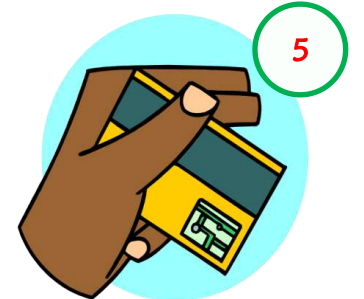
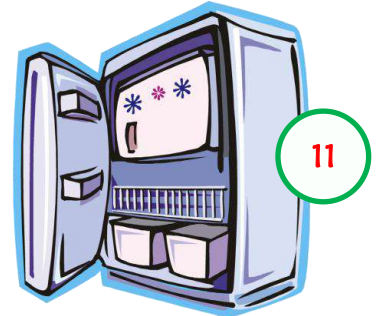
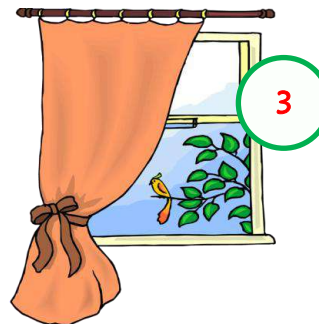
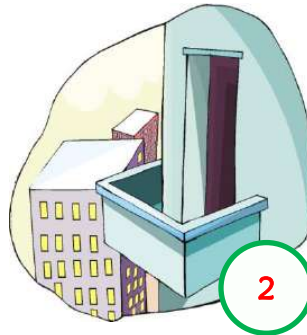
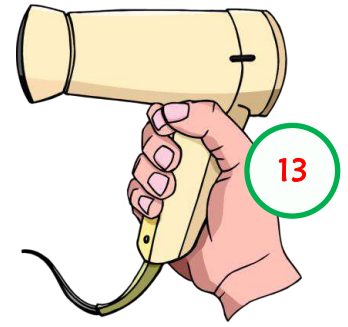
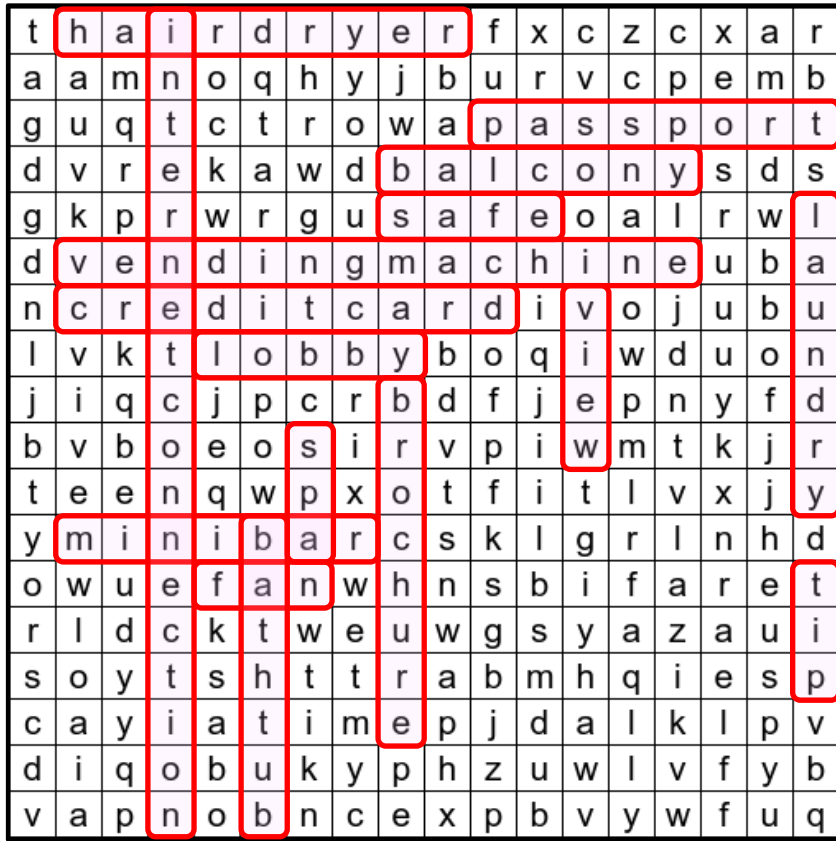

1. lobby
2. balcony
3. view
4. brochure
5. credit card
6. internet connection
7. safe
8. laundry
9. tip
10. passport
11. minibar
12. bathtub
13. hair dryer
14. fan
15. vending machine
16. spa

AT THE HOTEL CROSSWORD PUZZLE !

Look at the numbers on the pictures and write the hotel vocabulary in the crossword puzzle



9



5



12



11



3



13



2

14

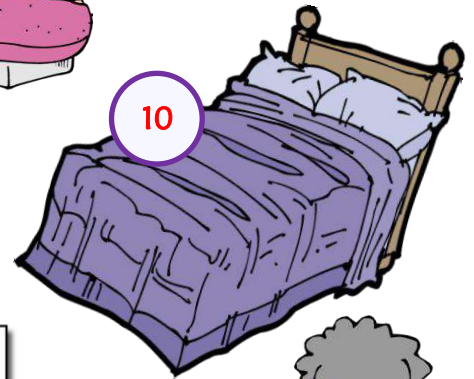
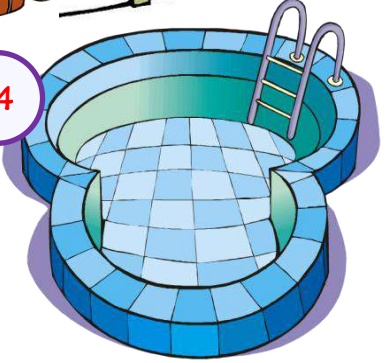

10

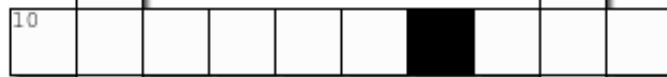

10



4



12



13

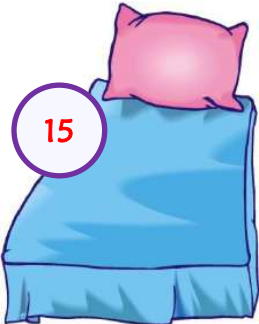

15



14



15

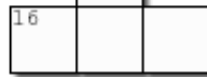

16

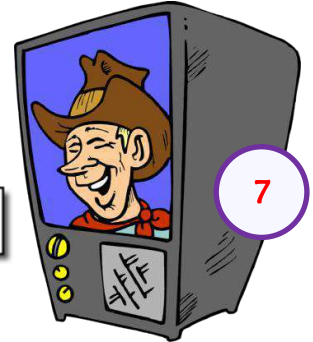

7



16



6

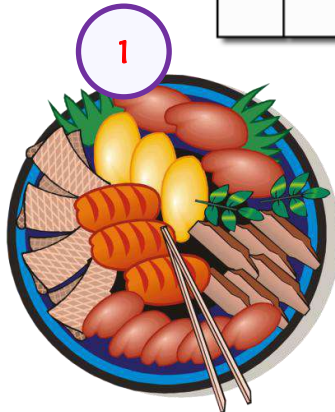

1

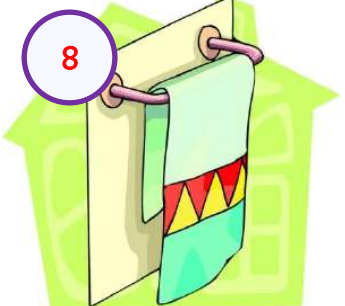

8

ANSWER KEY

Across

3. lift

7. television

10. double bed

12. reception

13. luggage

14. swimming pool

15. single bed

16. gym

Down

1. buffet

2. sauna

4. maid

5. key

6. air conditioner

8. towel

9. manager

11. bellboy

AT THE HOTEL CROSSWORD PUZZLE 2

Look at the numbers on the pictures and write the hotel vocabulary in the crossword puzzle



15

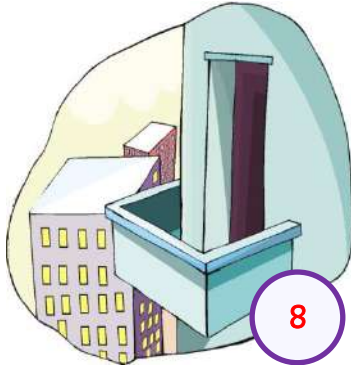

8



16



3



11



6

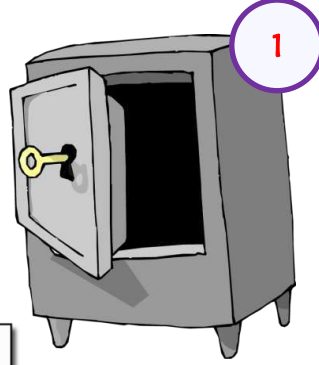

1



4

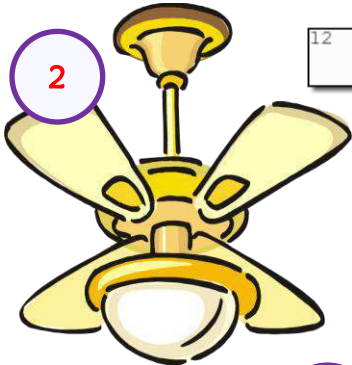

2

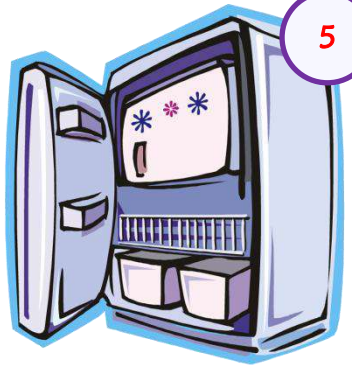

5



10



13



7



9

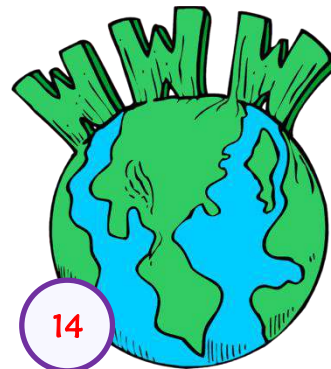

14



12

The crossword puzzle grid consists of white squares for letters and black squares for empty space. The starting points for the words are numbered as follows:

- 1: Down, 5 squares
- 2: Across, 2 squares
- 3: Down, 3 squares
- 4: Across, 4 squares
- 5: Across, 5 squares
- 6: Across, 2 squares
- 7: Down, 7 squares
- 8: Down, 8 squares
- 9: Down, 9 squares
- 10: Across, 10 squares
- 11: Down, 11 squares
- 12: Across, 2 squares
- 13: Across, 3 squares
- 14: Across, 14 squares
- 15: Across, 5 squares
- 16: Across, 3 squares

ANSWER KEY

Across

2. fan

3. brochure

6. tip

12. spa

14. internet connection

15. lobby

16. view

Down

1. safe

4. credit card

5. minibar

7. passport

8. balcony

9. vending machine

10. bathtub

11. laundry

13. hair dryer

AT THE HOTEL MISSING LETTERS IN WORDS !

Write the missing letters in the boxes to complete the hotel vocabulary



m_n_g_r

m__d



b_llb_y

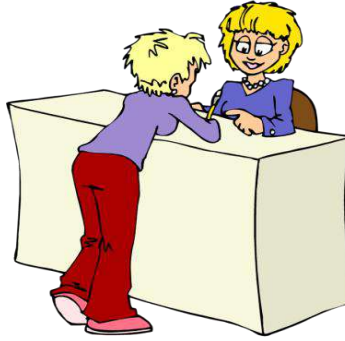

r_c_pt__n



l_gg_g_

l_ft

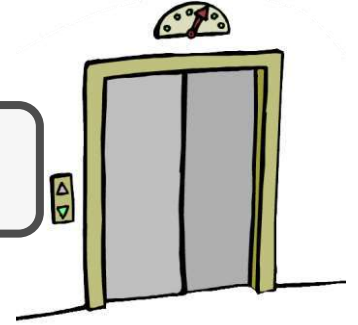

k_y

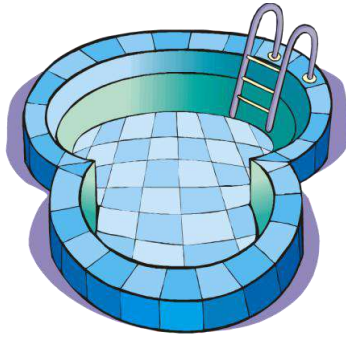

sw_mm_ng p__l



__r c_nd_t__n_r

b_ff_t

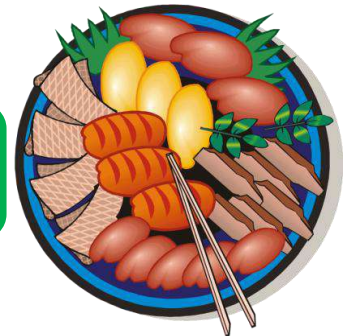

g_m



s__n__



d__bl__b_d

t_w_l

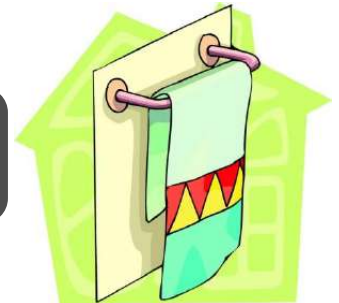

s_ngl__b_d

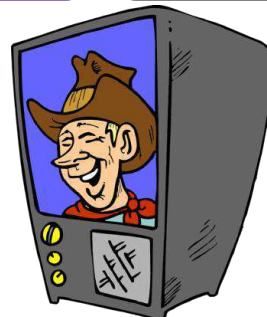

t_l_v_s__n

AT THE HOTEL MISSING LETTERS IN WORDS 2

Write the missing letters in the boxes to complete the hotel vocabulary

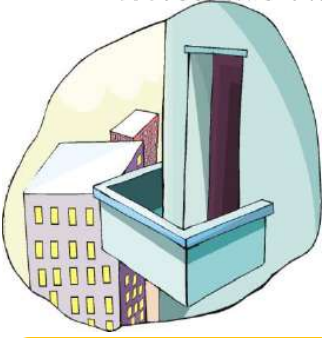

b_l_c_ny

cr_d_t c_rd



v__w

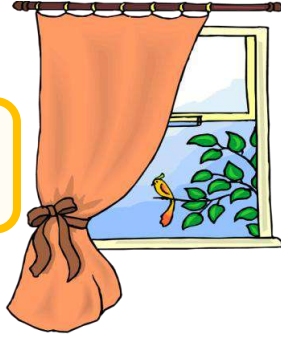

br_ch_r_



l_bby

l__ndry



_nt_rn_t c_nn_ct__n



t_p

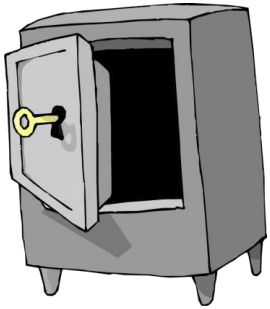

s_f_

p_ssp_rt

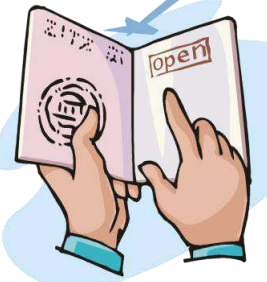

m_n_b_r

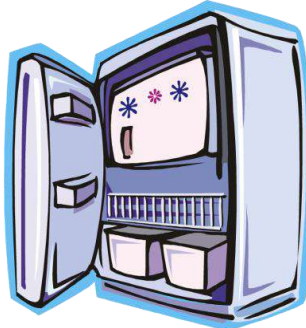

b_tht_b



h__r dry_r

sp_



v_nd_ng m_ch_n_

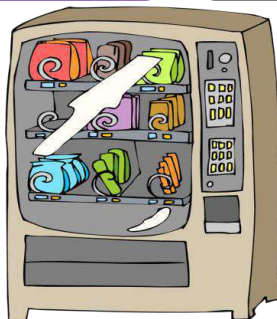

f_n

AT THE HOTEL MISSING LETTERS IN WORDS | ANSWER KEY

Write the missing letters in the boxes to complete the hotel vocabulary



mananer

maid



bellboy

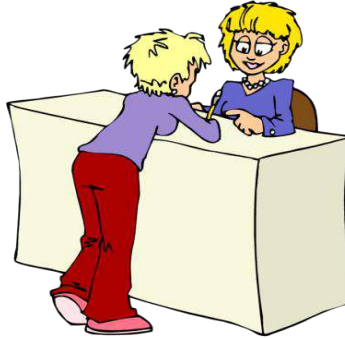

reception



luggage

lift

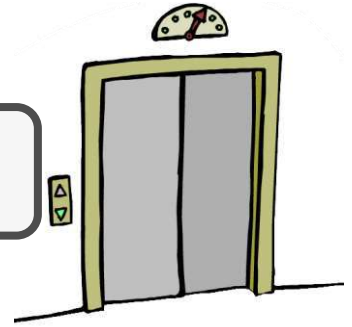

key

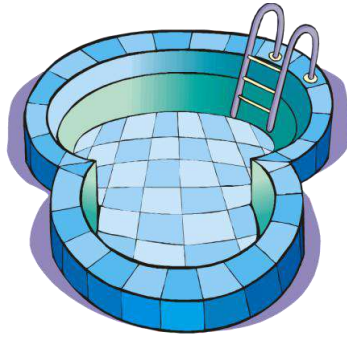

swimming pool



air conditioner

buffet

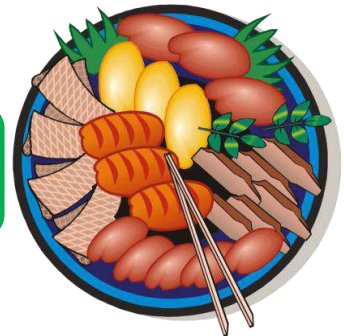

gym



sauna

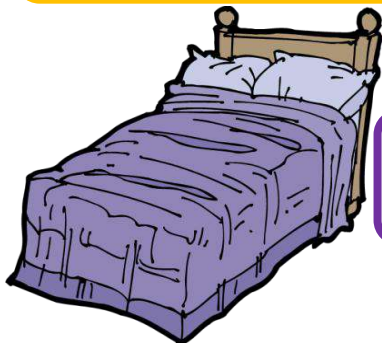

double bed

towel

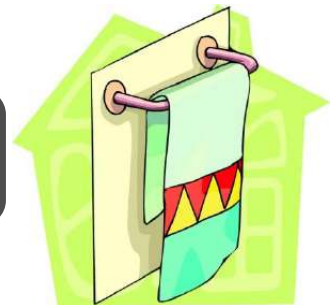

single bed

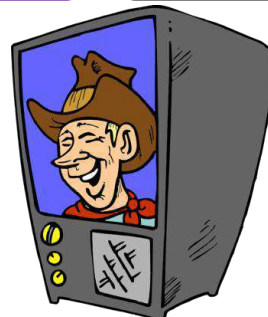

television

AT THE HOTEL MISSING LETTERS IN WORDS 2 ANSWER KEY

Write the missing letters in the boxes to complete the hotel vocabulary

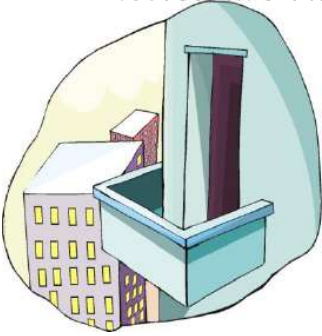

balcony

credit card



view

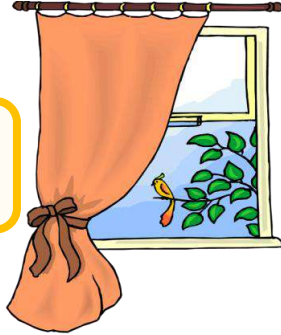

brochure



lobby

laudry



internet connection



tip

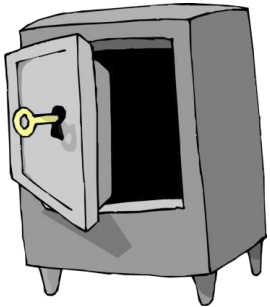

safe

passport



minibar

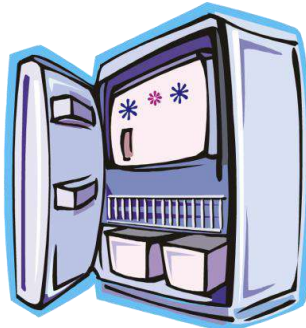

bathtub



hair dryer

spa



vending machine

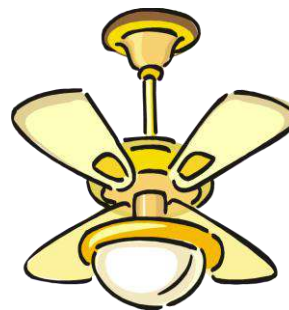

fan

AT THE HOTEL UNSCRAMBLE THE WORDS !

Unscramble the hotel vocabulary and number the pictures

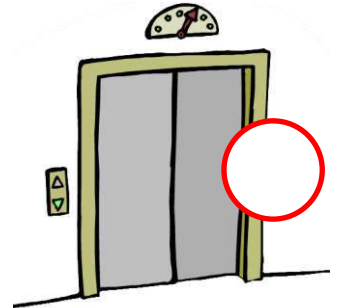
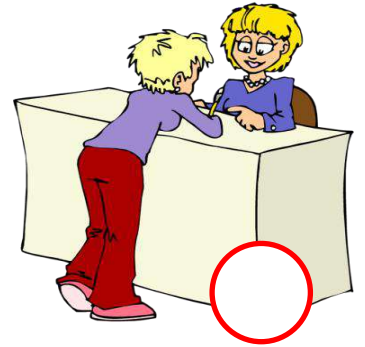
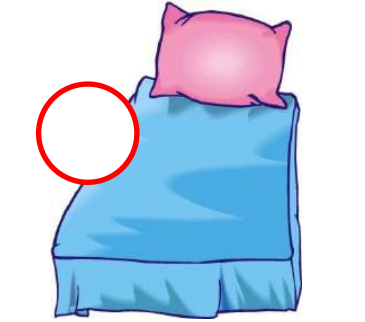
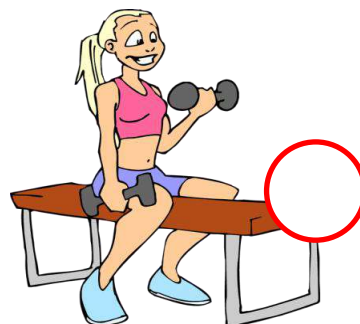
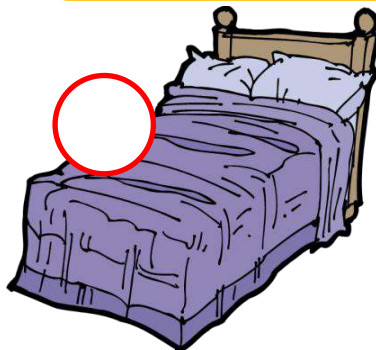
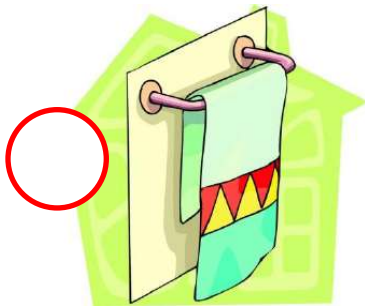
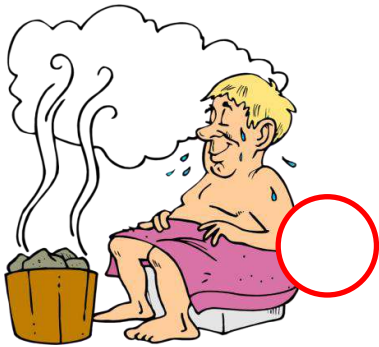
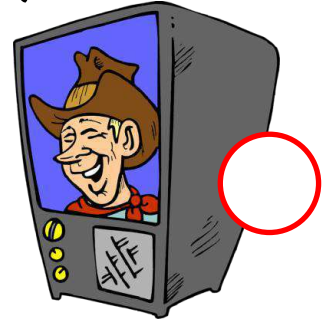
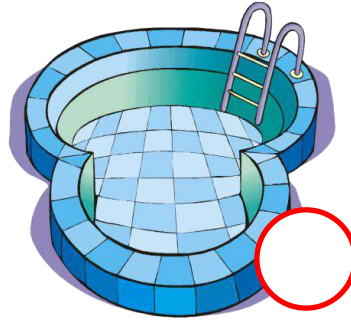
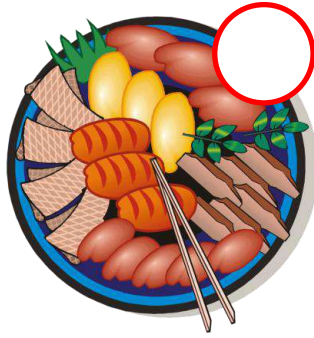

1. oeitneprc _____
2. elobylb _____
3. idma _____
4. arnmega _____
5. uglageg _____
6. eky _____
7. wigmnims olop _____
8. iftl _____
9. ira cniritoodne _____
10. nuaas _____
11. ffbtue _____
12. ymg _____
13. lduebo bde _____
14. nelgis bde _____
15. oetwl _____
16. seintolvei _____

AT THE HOTEL UNSCRAMBLE THE WORDS 2

Unscramble the hotel vocabulary and number the pictures

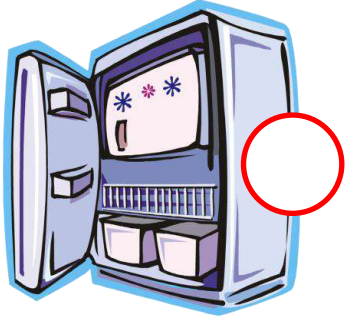
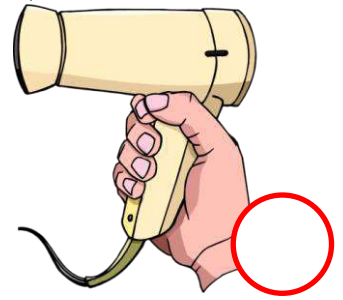
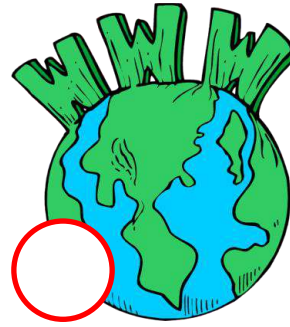

1. lybob

2. acblyno

3. wvei

4. ceobuhrr

5. tcdrei adrc

6. ienerttn oinnctotec

7. sfea

8. rnluyad

9. ipt

10. sptoarps

11. mibrian

12. utabthb

13. raih rreyd

14. fna

15. nnvedgi ehanmci

16. psa

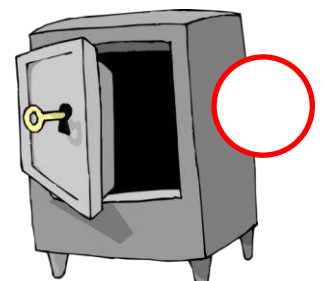
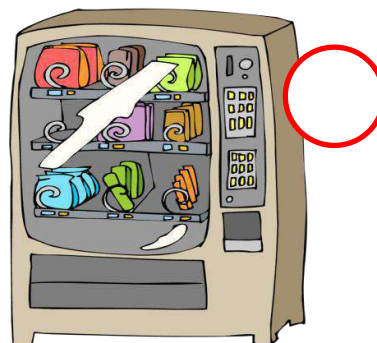
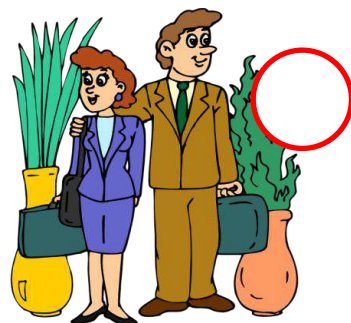
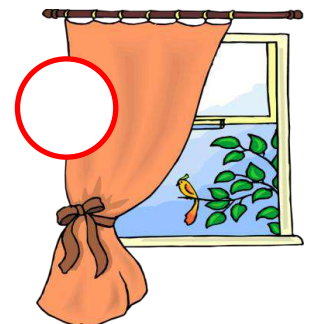
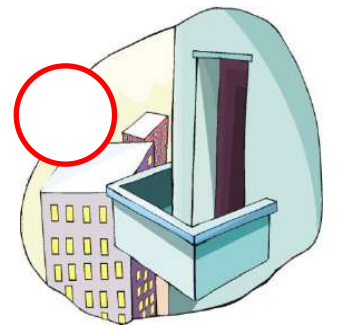
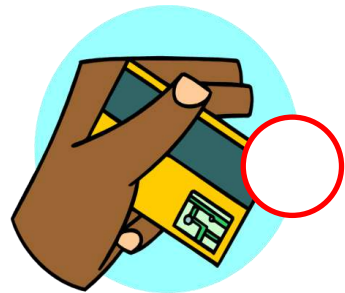
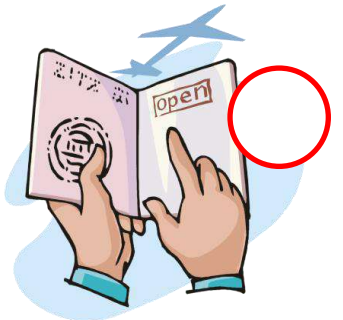
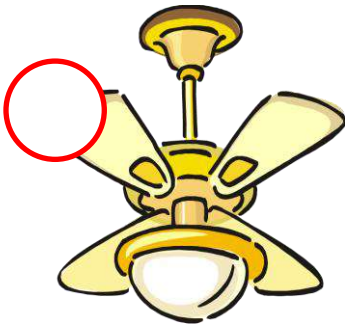

AT THE HOTEL UNSCRAMBLE THE WORDS | ANSWER KEY

Unscramble the hotel vocabulary and number the pictures

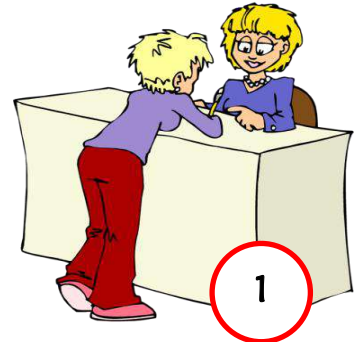
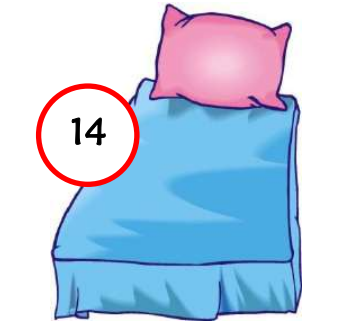
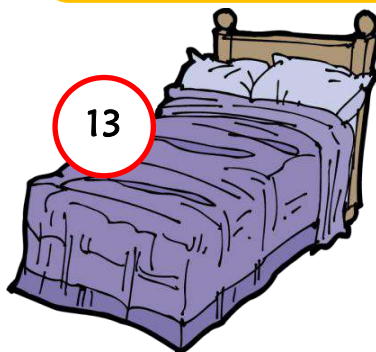
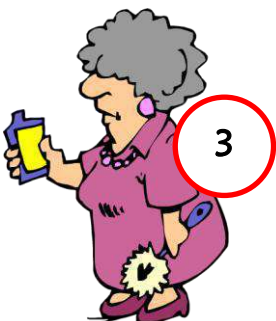
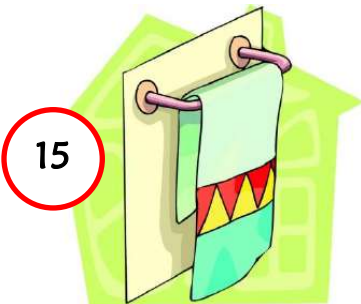
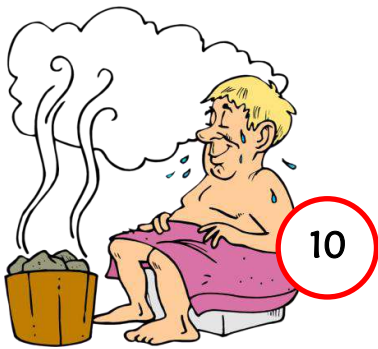
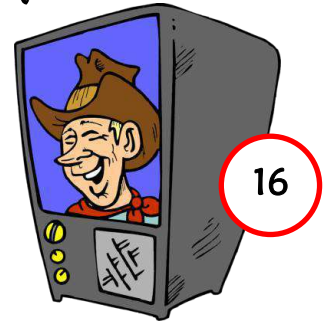
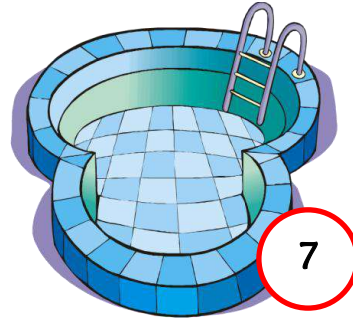
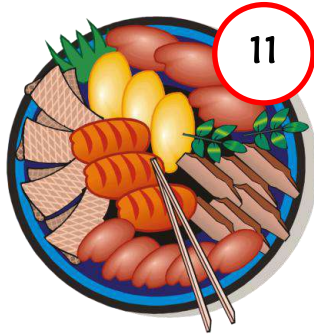

- | | |
|-------------------|-----------------|
| 1. oeitnprc | reception |
| 2. elobybl | bellboy |
| 3. idma | maid |
| 4. arnmega | manager |
| 5. uglageg | luggage |
| 6. eky | key |
| 7. wigmnims olop | swimming pool |
| 8. iftl | lift |
| 9. ira cnritoodne | air conditioner |
| 10. nuaas | sauna |
| 11. ffbtue | buffet |
| 12. ymg | gym |
| 13. lduebo bde | double bed |
| 14. nelgis bde | single bed |
| 15. oetwl | towel |
| 16. seintolvei | television |

AT THE HOTEL UNSCRAMBLE THE WORDS 2 ANSWER KEY

Unscramble the hotel vocabulary and number the pictures

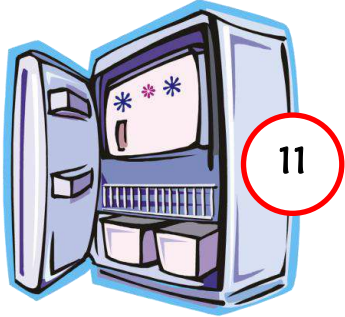
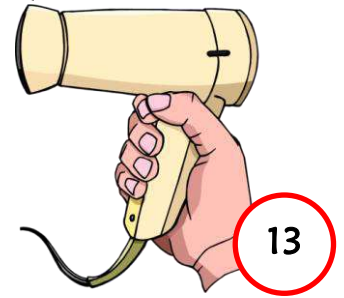
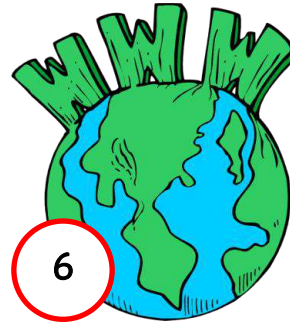

1. lybob

lobby

2. acblyno

balcony

3. wvei

view

4. ceobuhrr

brochure

5. tcdrei adrc

credit card

6. ienerttn oinnctotec internet connection

7. sfea

safe

8. nrluyad

laundry

9. ipt

tip

10. sptoarps

passport

11. mibrian

minibar

12. utabthb

bathtub

13. raih rreyd

hair dryer

14. fna

fan

15. nnvedgi ehanmci vending machine

16. psa

spa

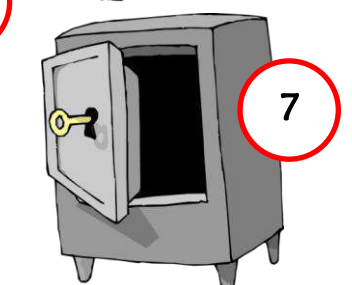
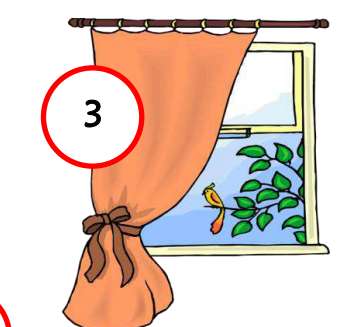
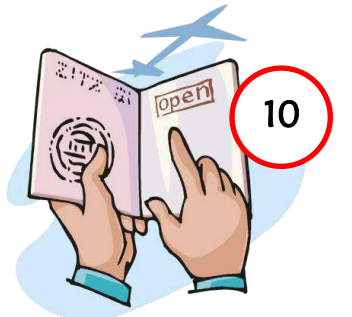
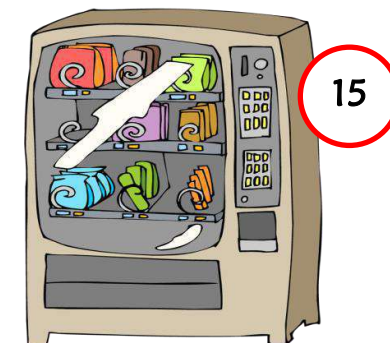
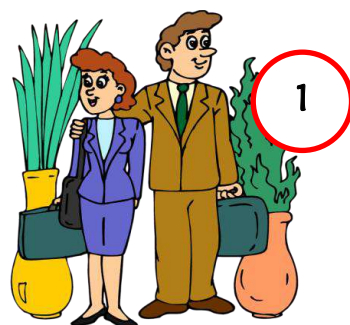
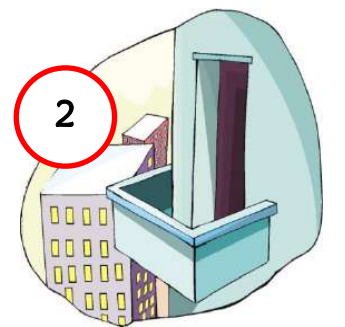
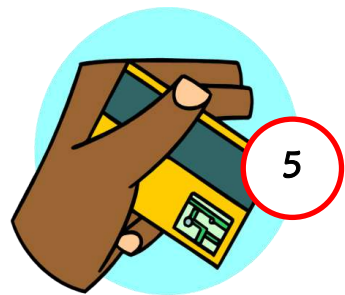
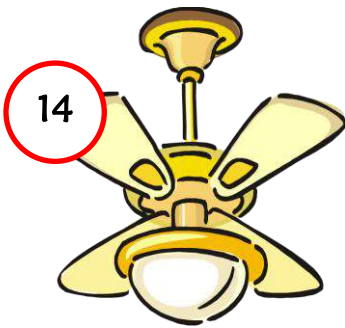

AT THE HOTEL MULTIPLE CHOICE TEST !

Look at the pictures, choose and circle the correct option.

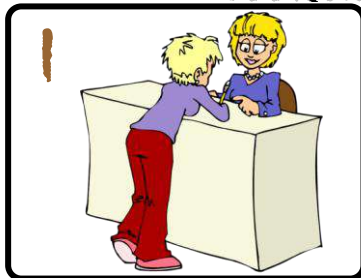

- a) swimming pool
- b) sauna
- c) reception
- d) television



- a) bellboy
- b) lift
- c) buffet
- d) double bed



- a) gym
- b) luggage
- c) single bed
- d) maid

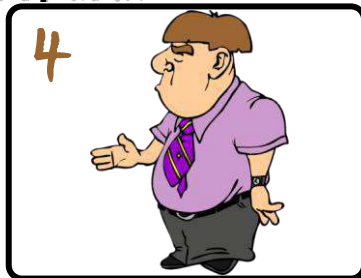

- a) towel
- b) manager
- c) key
- d) air conditioner



- a) single bed
- b) maid
- c) luggage
- d) gym

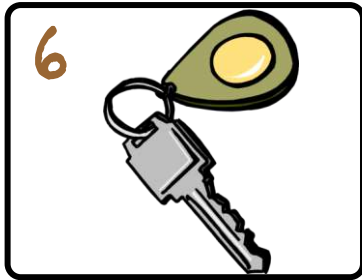

- a) buffet
- b) towel
- c) manager
- d) key

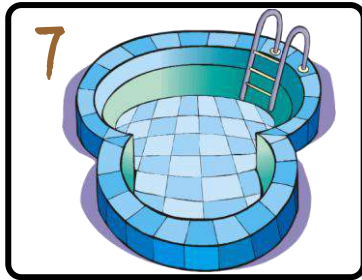

- a) air conditioner
- b) double bed
- c) swimming pool
- d) reception

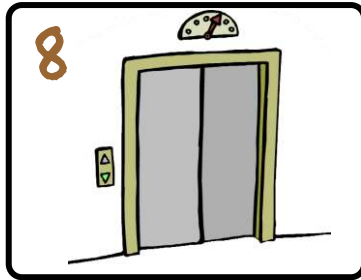

- a) television
- b) sauna
- c) bellboy
- d) lift



- a) television
- b) air conditioner
- c) reception
- d) swimming pool



- a) sauna
- b) lift
- c) maid
- d) double bed

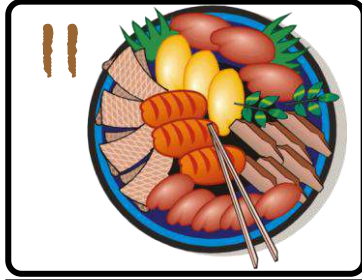

- a) single bed
- b) key
- c) bellboy
- d) buffet



- a) luggage
- b) towel
- c) gym
- d) manager



- a) bellboy
- b) double bed
- c) buffet
- d) luggage



- a) air conditioner
- b) manager
- c) swimming pool
- d) single bed

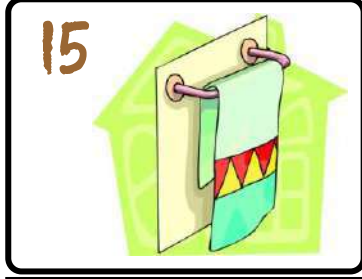

- a) towel
- b) reception
- c) lift
- d) sauna

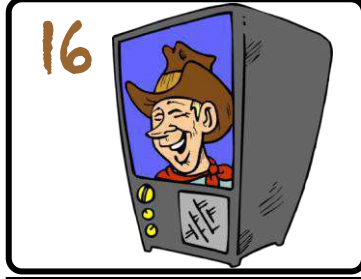

- a) maid
- b) gym
- c) television
- d) key

AT THE HOTEL MULTIPLE CHOICE TEST 2

Look at the pictures, choose and circle the correct option.

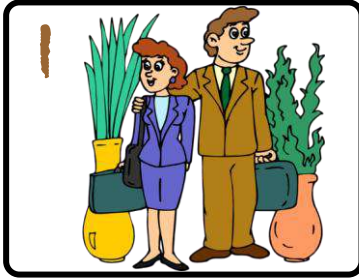

- a) passport
- b) lobby
- c) safe
- d) hair dryer

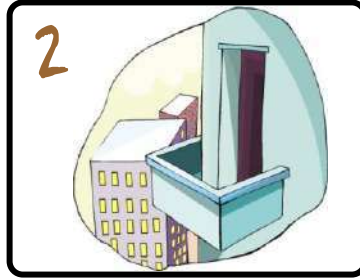

- a) laundry
- b) spa
- c) minibar
- d) balcony

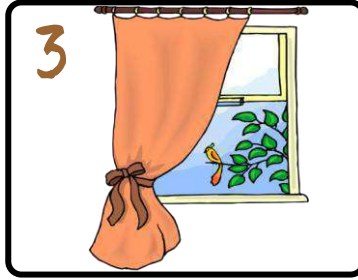

- a) bathtub
- b) view
- c) credit card
- d) fan

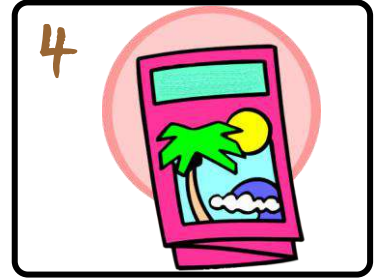

- a) brochure
- b) internet connection
- c) vending machine
- d) tip



- a) view
- b) spa
- c) bathtub
- d) credit card



- a) tip
- b) vending machine
- c) internet connection
- d) brochure

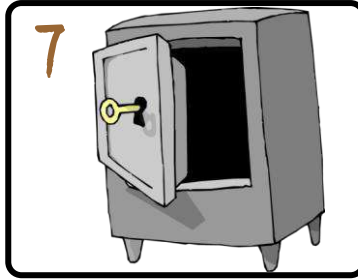

- a) safe
- b) passport
- c) hair dryer
- d) lobby



- a) minibar
- b) balcony
- c) laundry
- d) fan



- a) balcony
- b) tip
- c) fan
- d) safe



- a) lobby
- b) credit card
- c) hair dryer
- d) passport

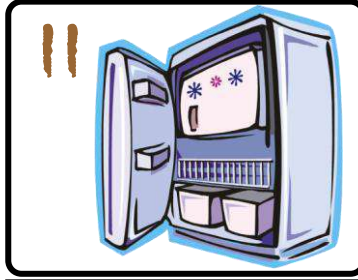

- a) internet connection
- b) brochure
- c) spa
- d) minibar



- a) laundry
- b) bathtub
- c) view
- d) vending machine

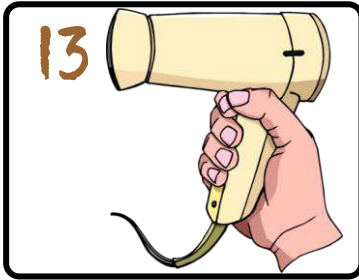

- a) hair dryer
- b) minibar
- c) brochure
- d) laundry

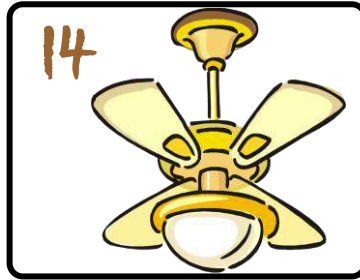

- a) tip
- b) safe
- c) fan
- d) view

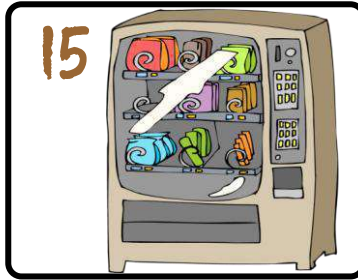

- a) vending machine
- b) passport
- c) balcony
- d) internet connection



- a) credit card
- b) spa
- c) lobby
- d) balcony

AT THE HOSPITAL MULTIPLE CHOICE TESTS ANSWER KEY

TEST 1

- 1) c
- 2) a
- 3) d
- 4) b
- 5) c
- 6) d
- 7) c
- 8) d
- 9) b
- 10) a
- 11) d
- 12) c
- 13) b
- 14) d
- 15) a
- 16) c

TEST 2

- 1) b
- 2) d
- 3) b
- 4) a
- 5) d
- 6) c
- 7) a
- 8) c
- 9) b
- 10) d
- 11) d
- 12) b
- 13) a
- 14) c
- 15) a
- 16) b

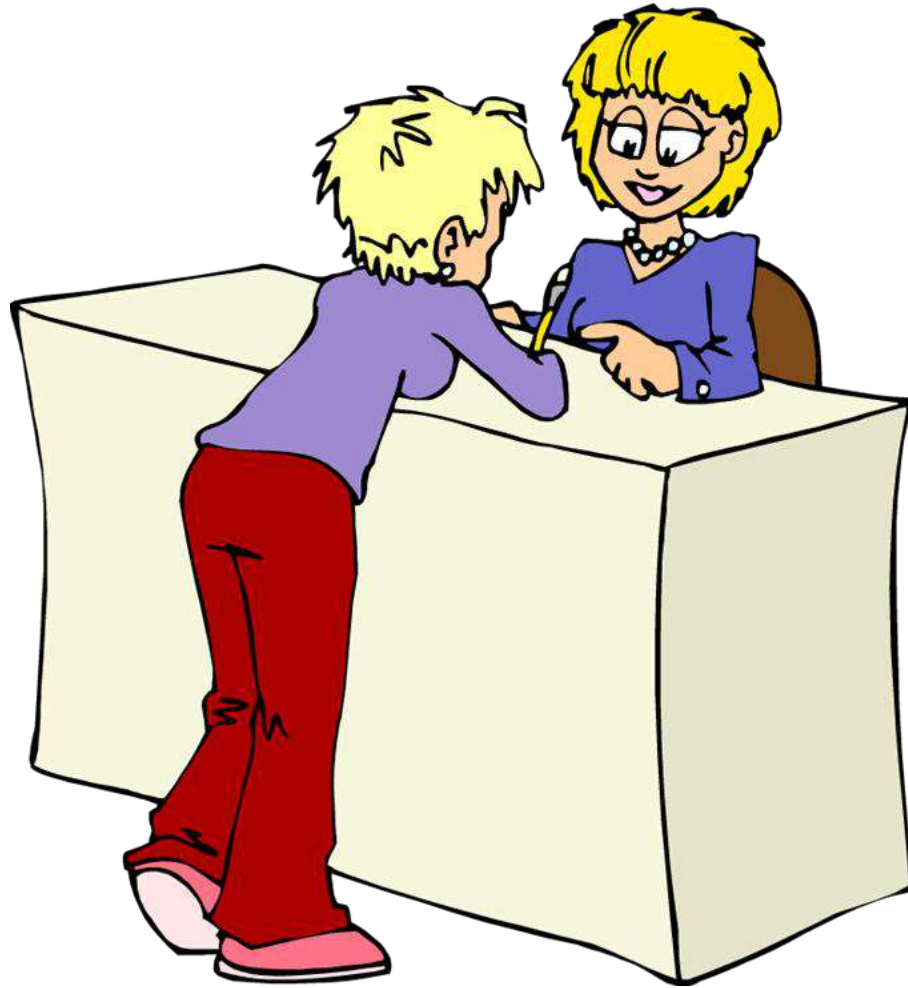

reception



bellboy



maid



manager



luggage



key

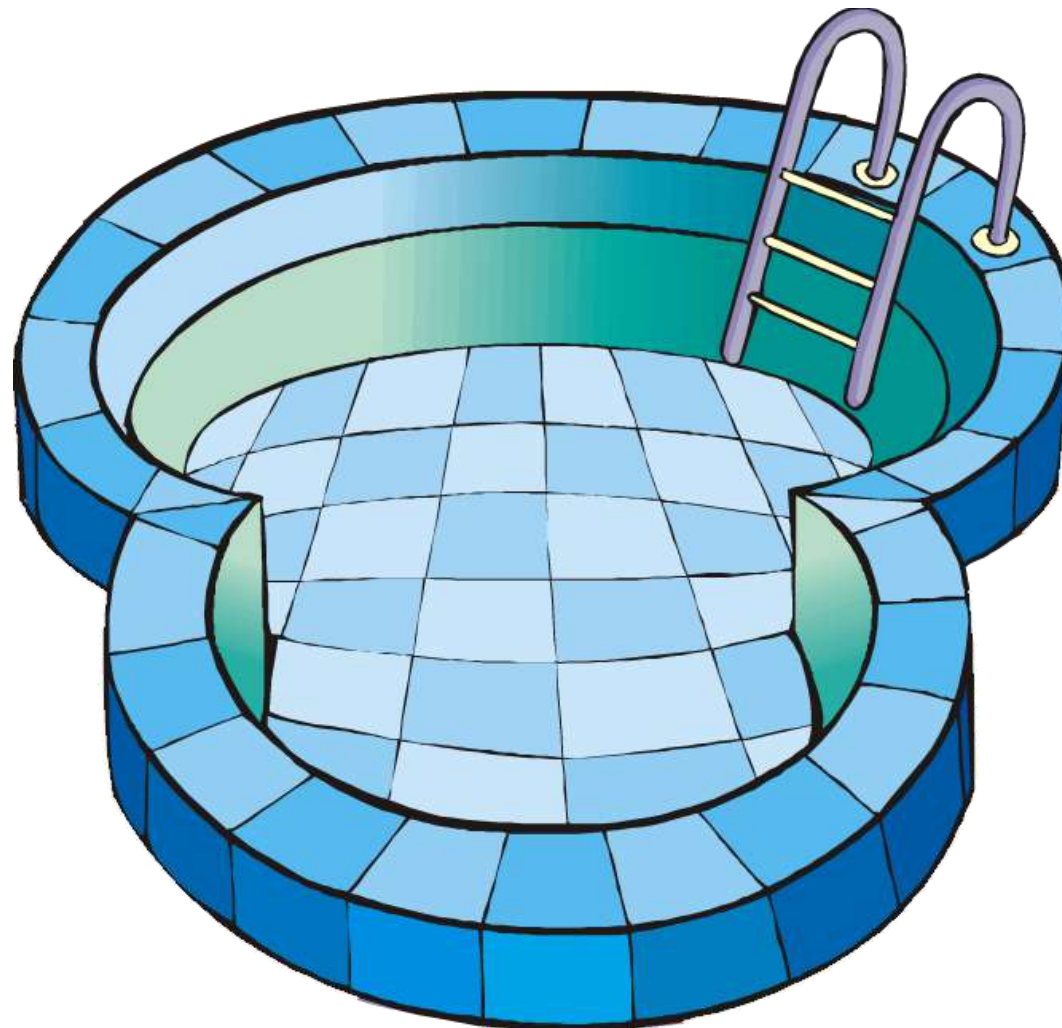

swimming pool

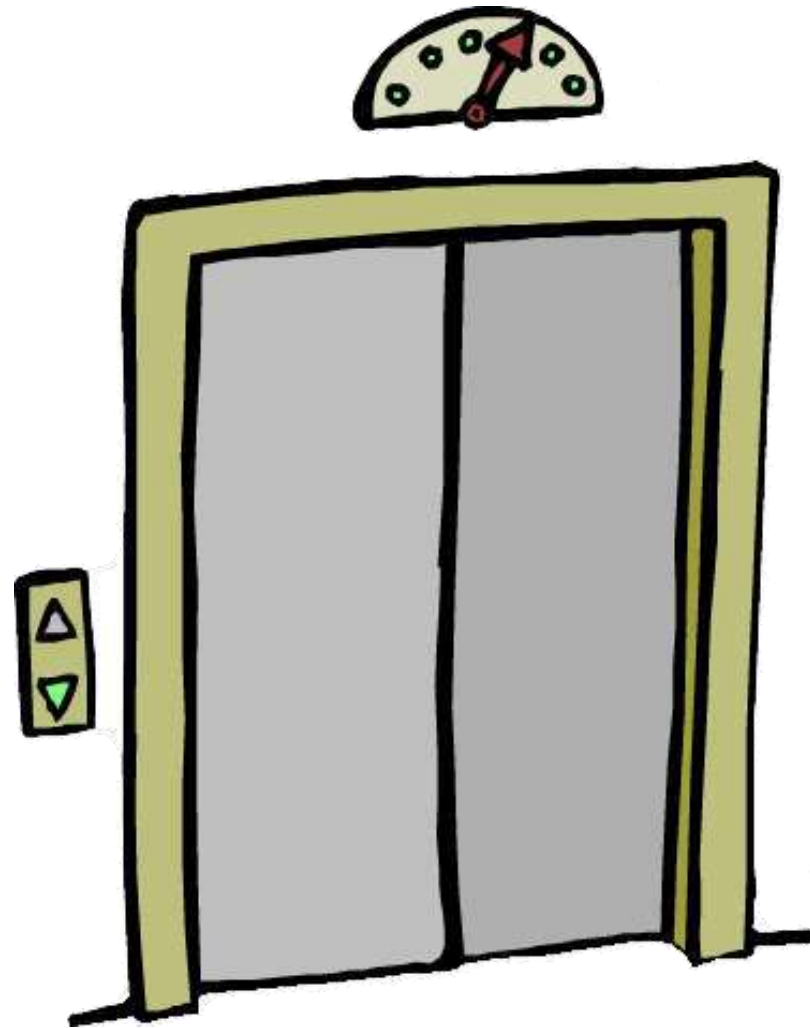

lift



air conditioner



sauna

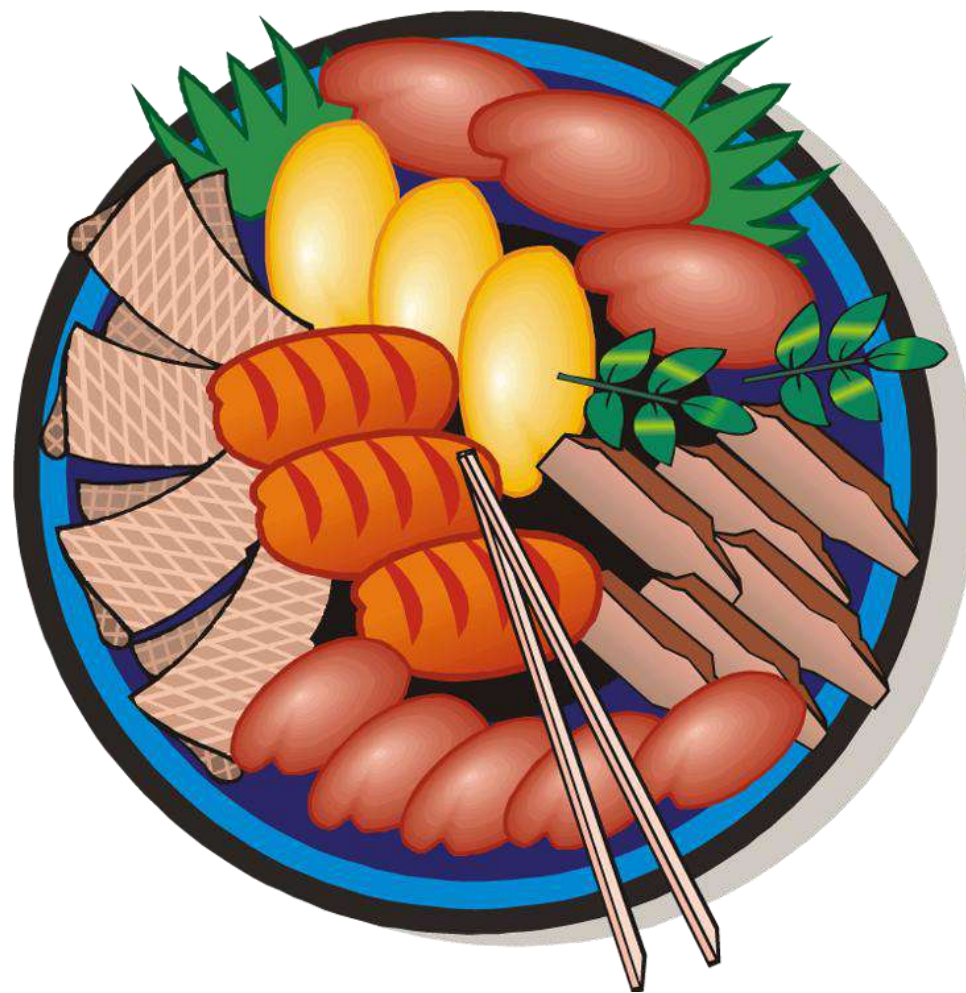

buffet



gym

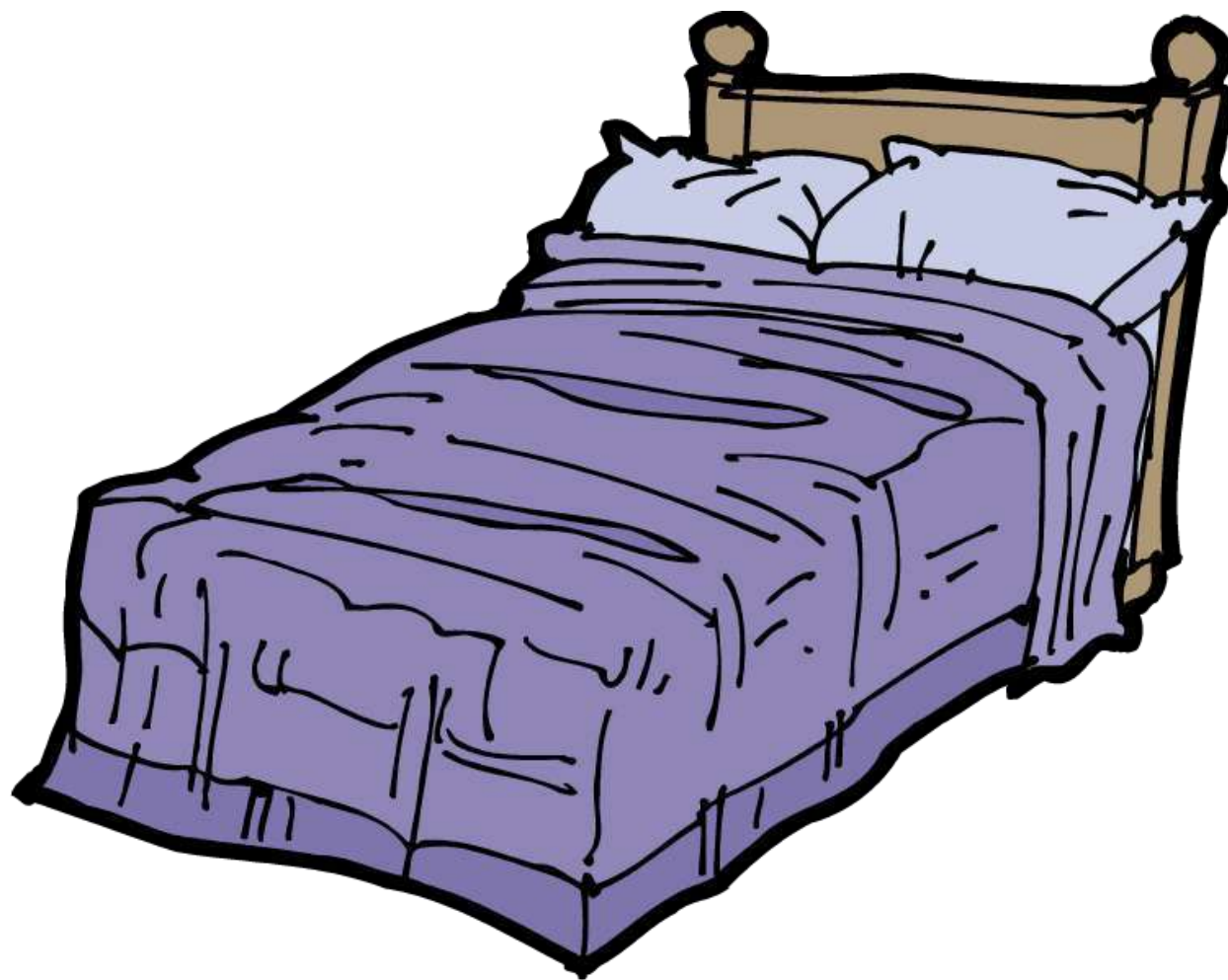

double bed



single bed

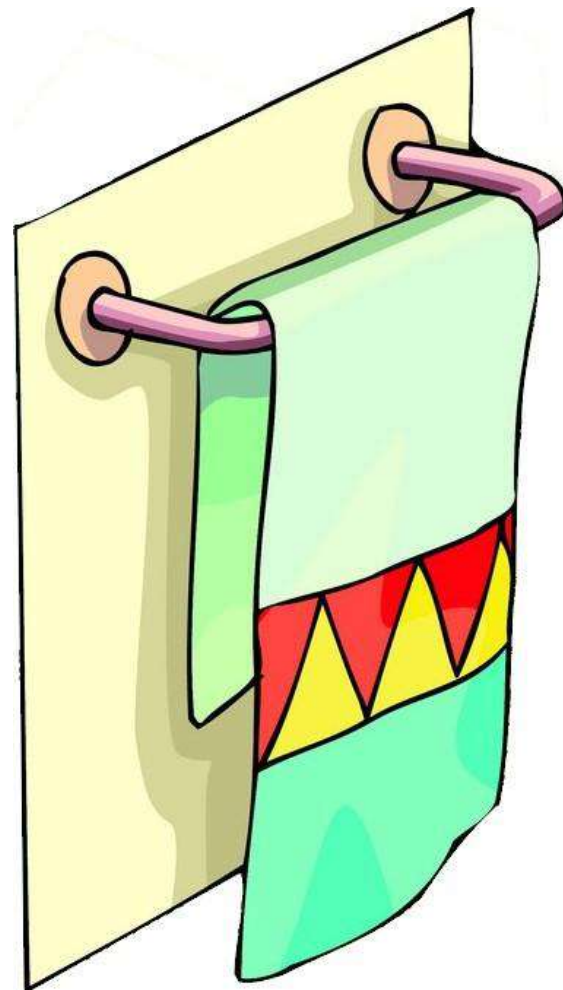

towel

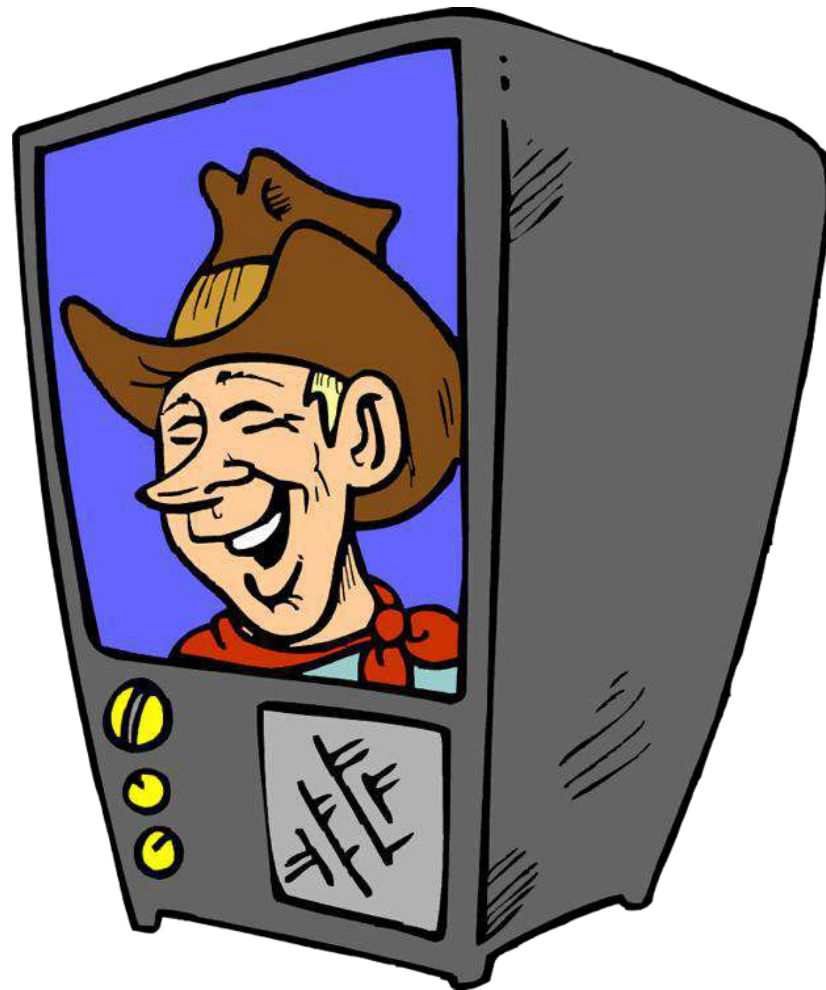

television



lobby

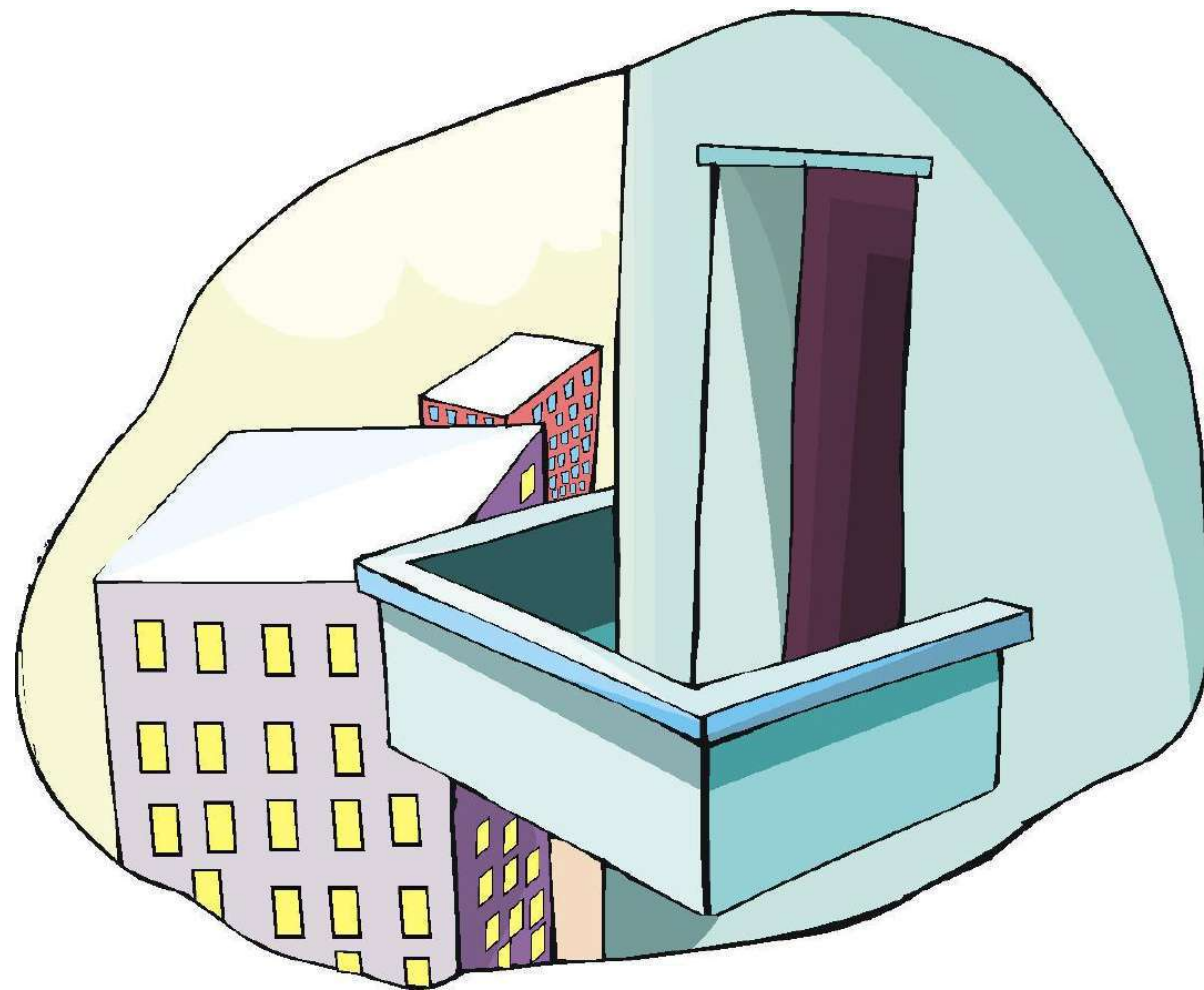

balcony



view



brochure



credit card



internet connection

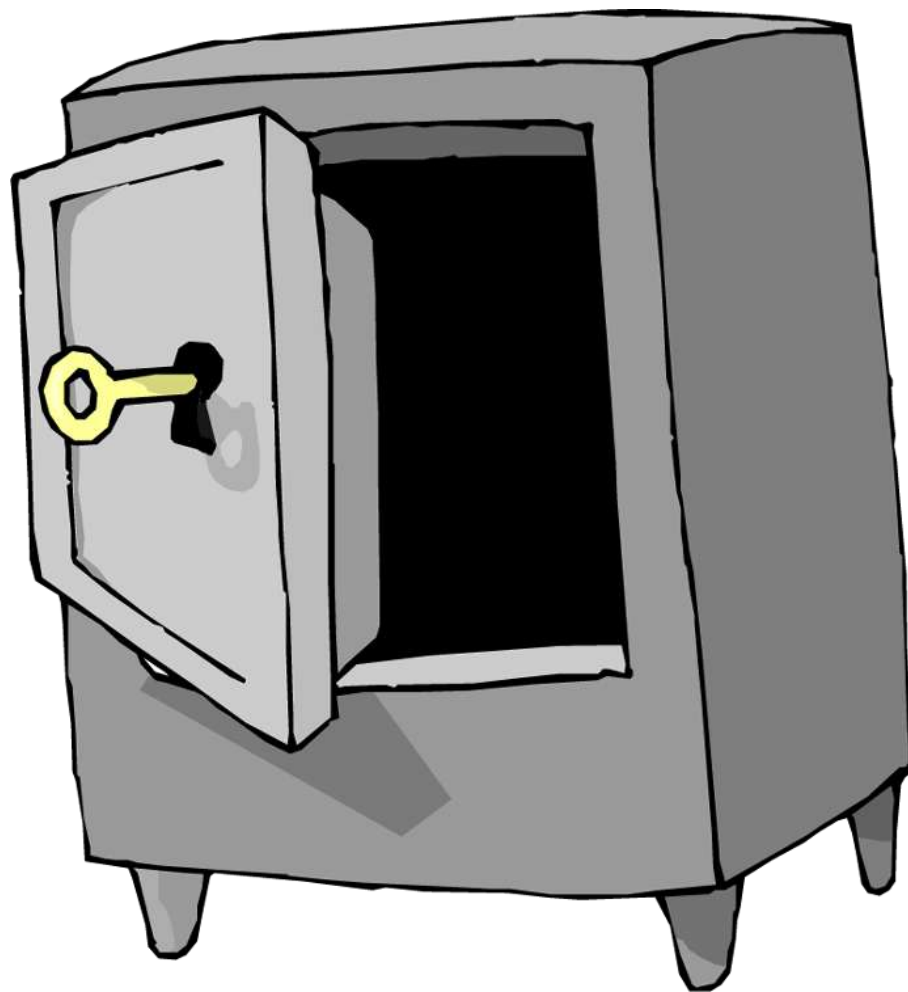

safe



laundry



tip

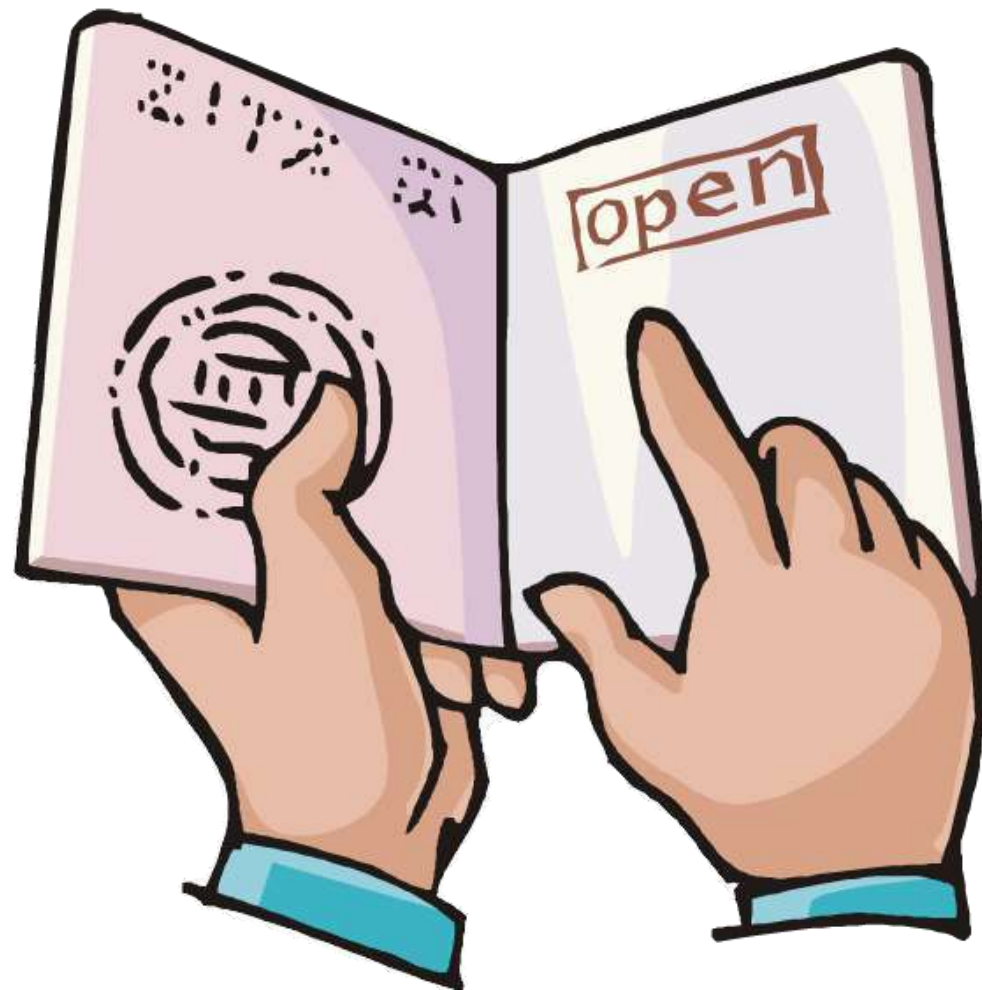

passport

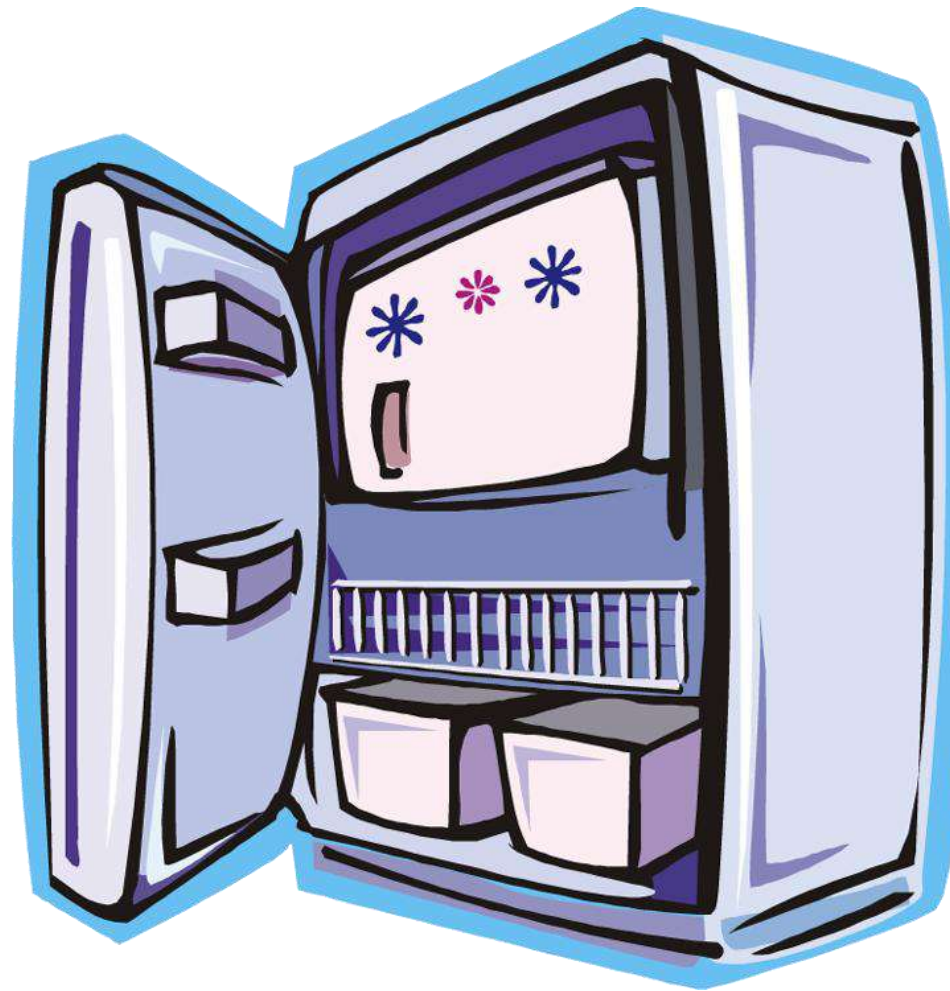

minibar



bathtub



hair dryer

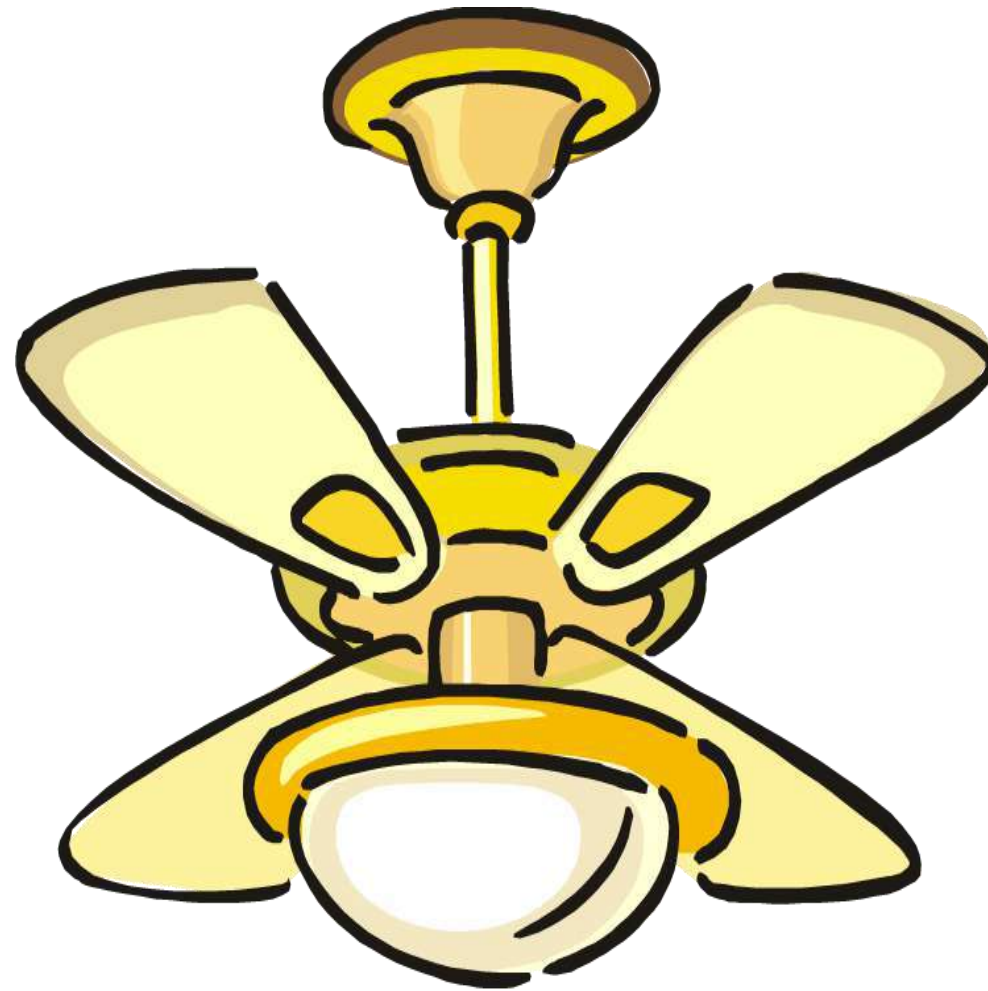

fan



vending machine



spa













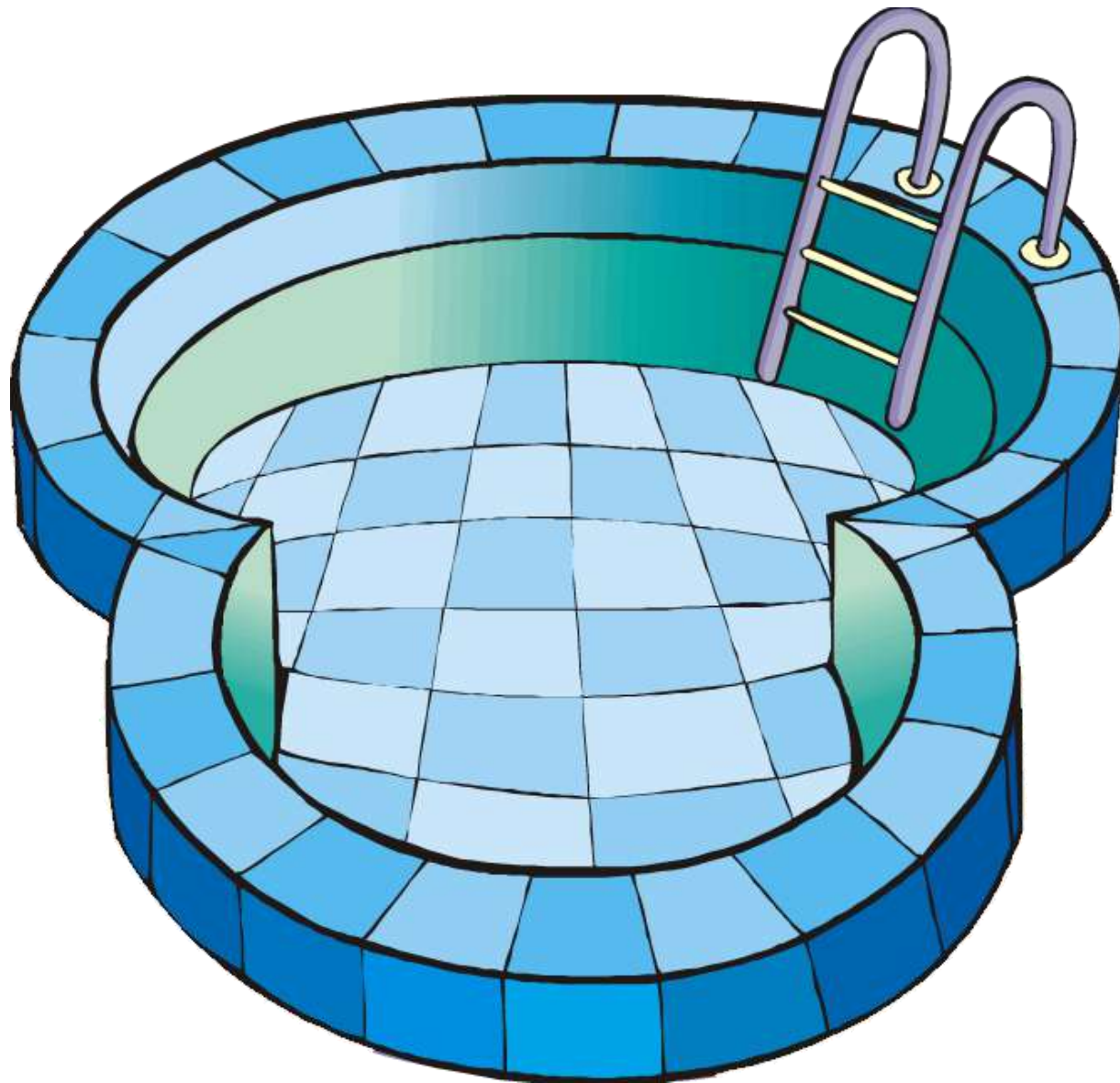

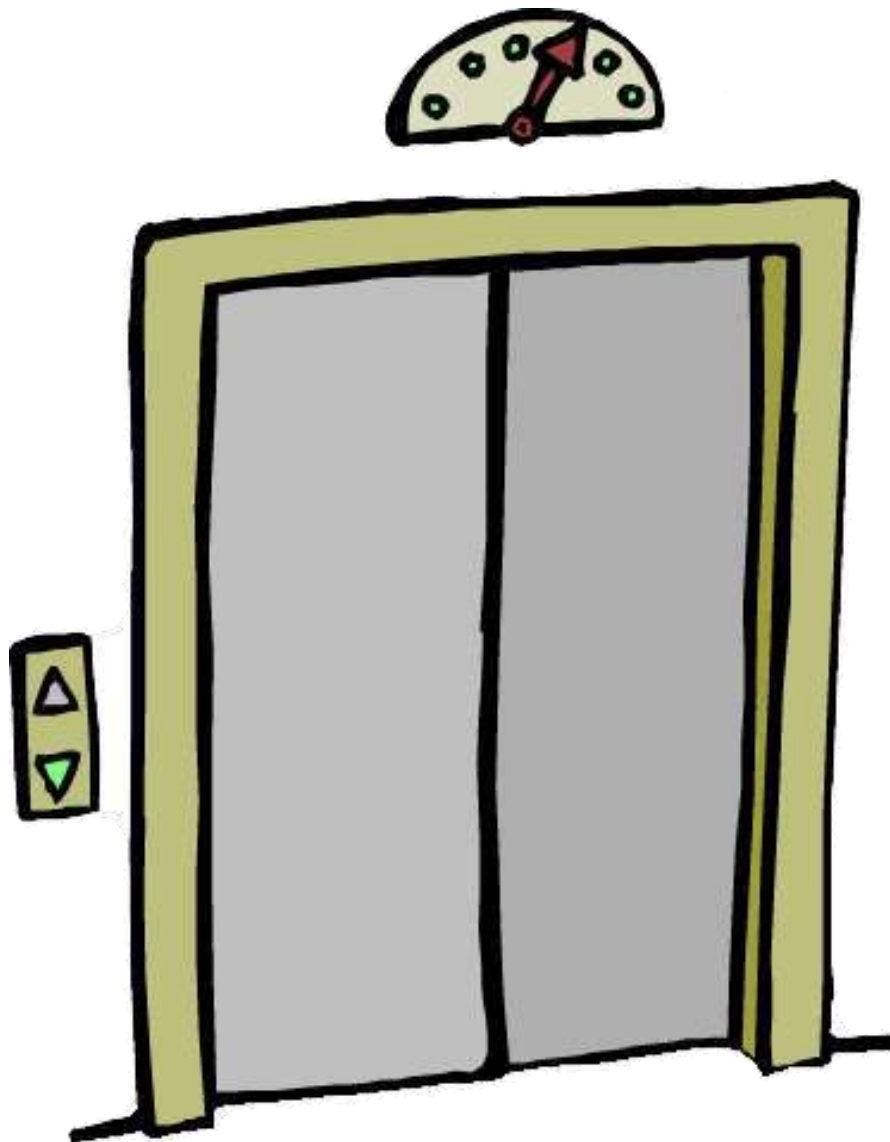





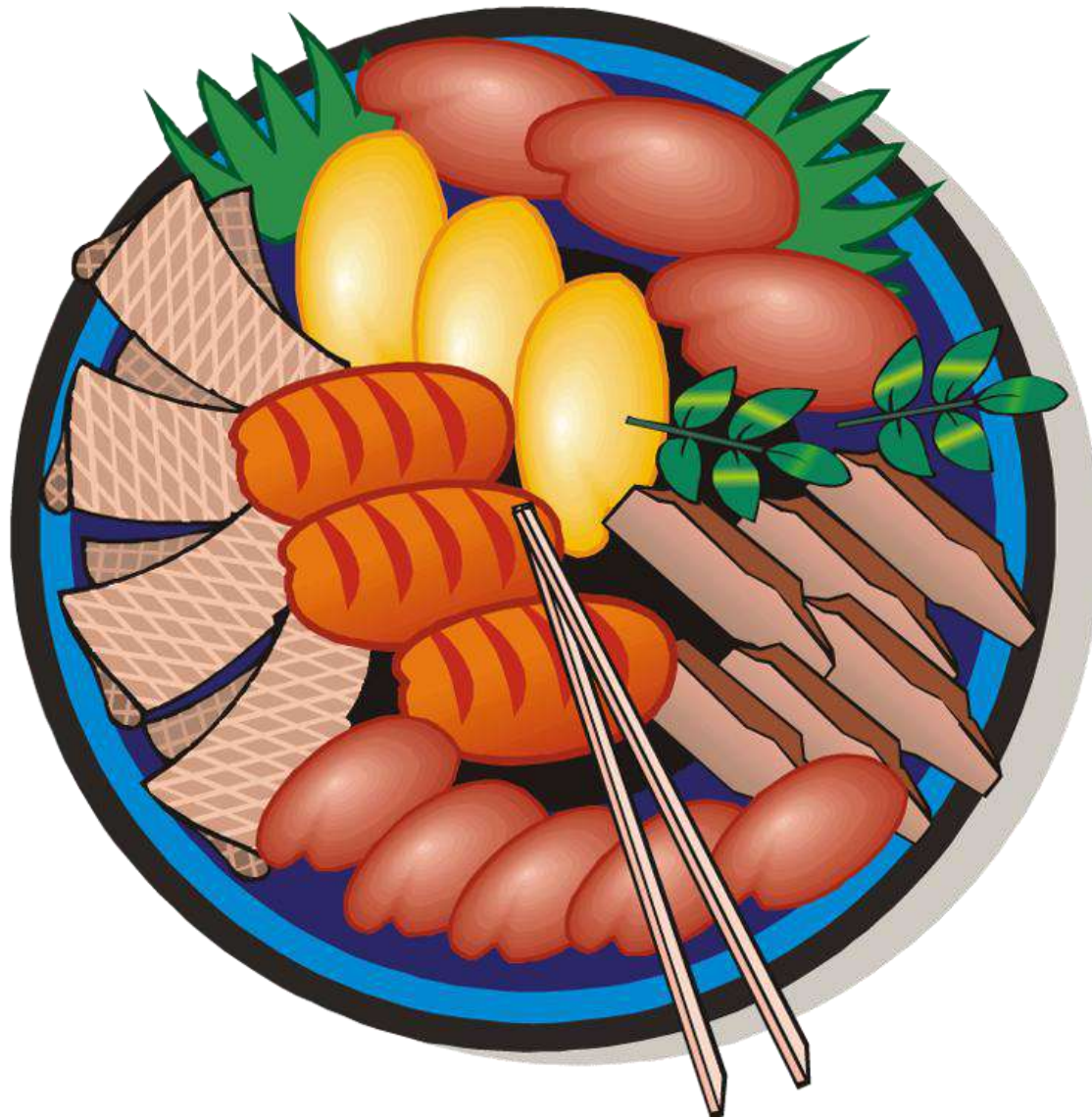



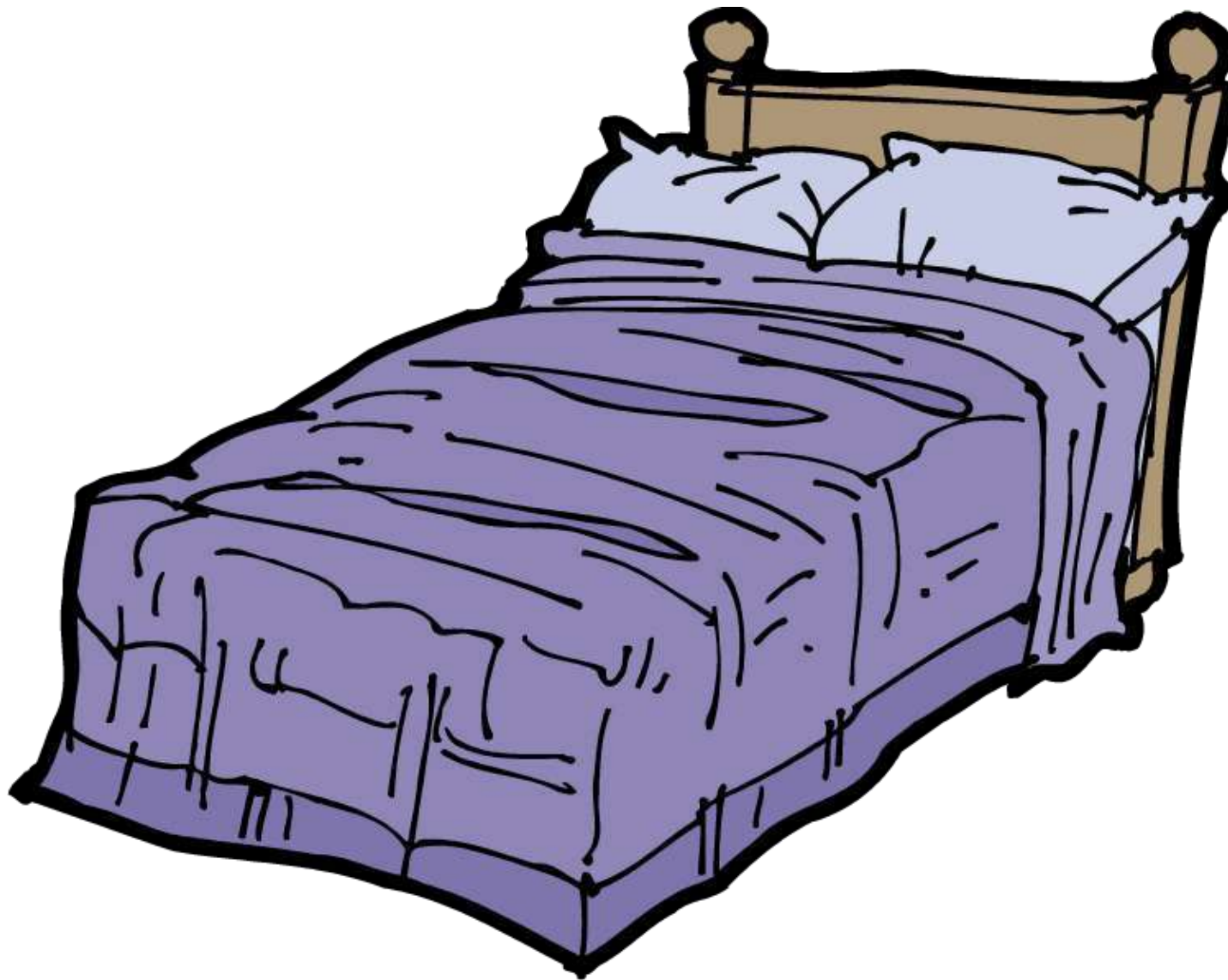



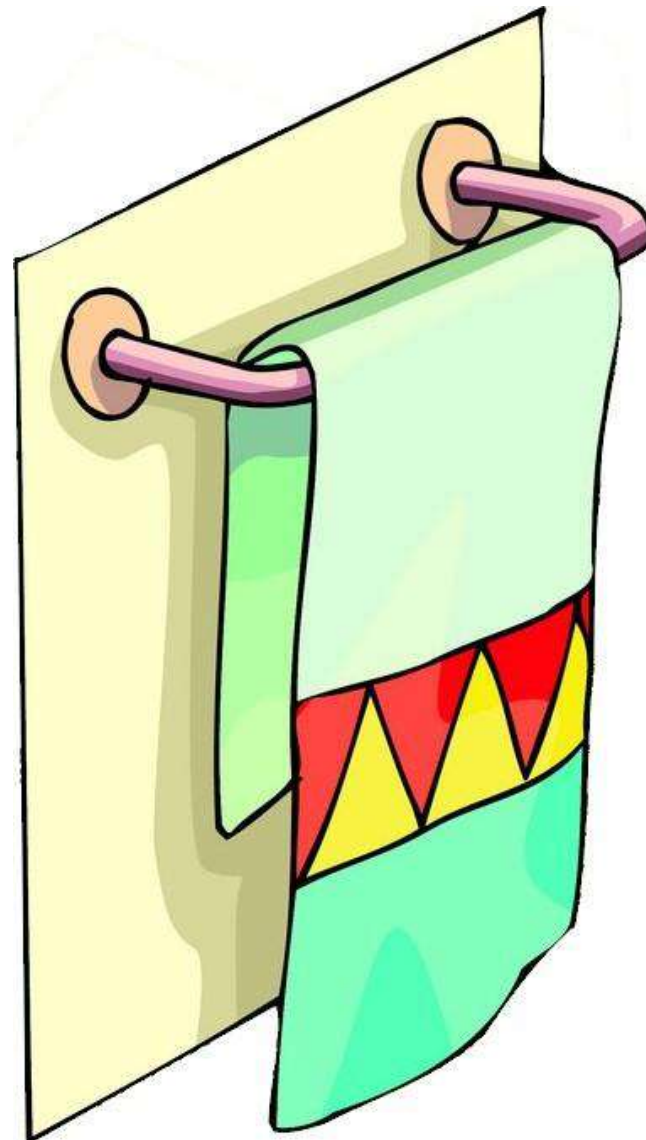

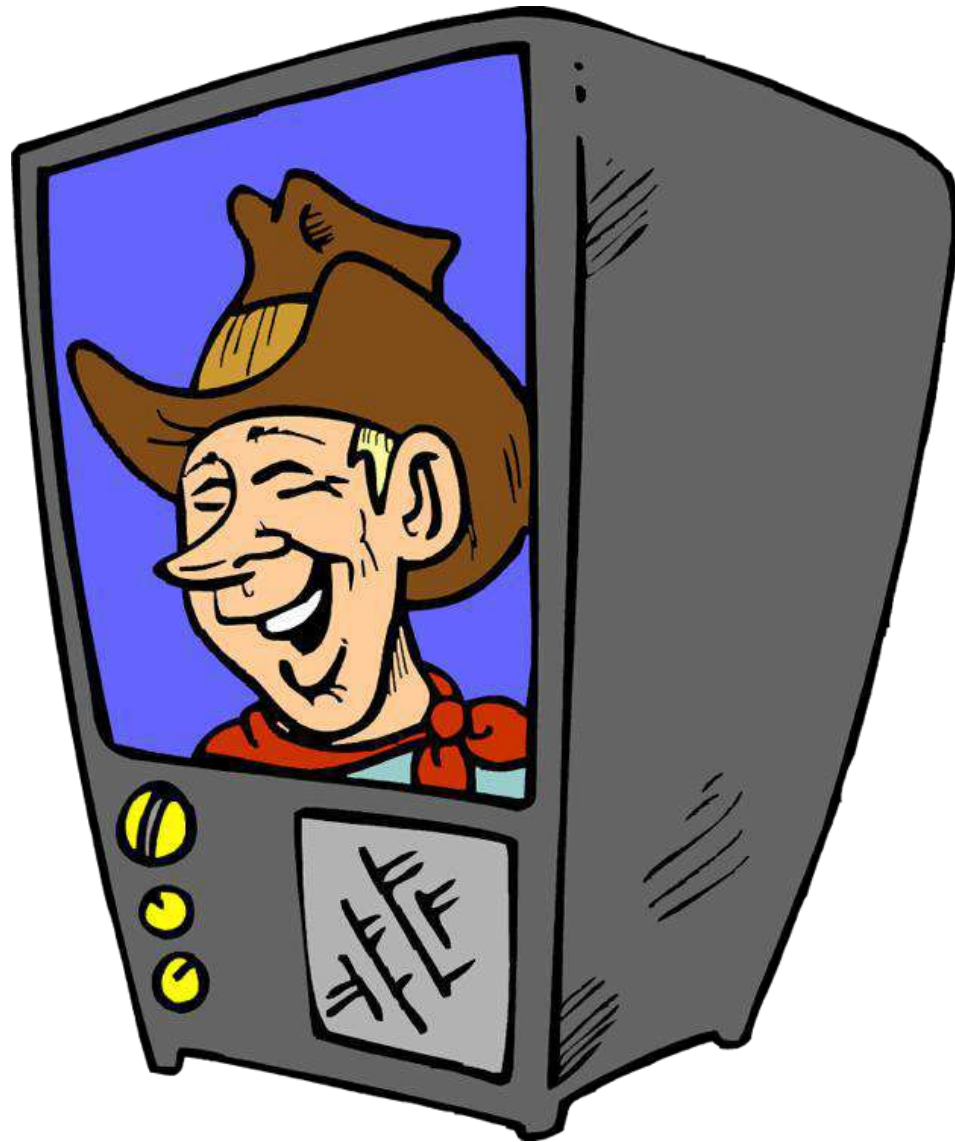



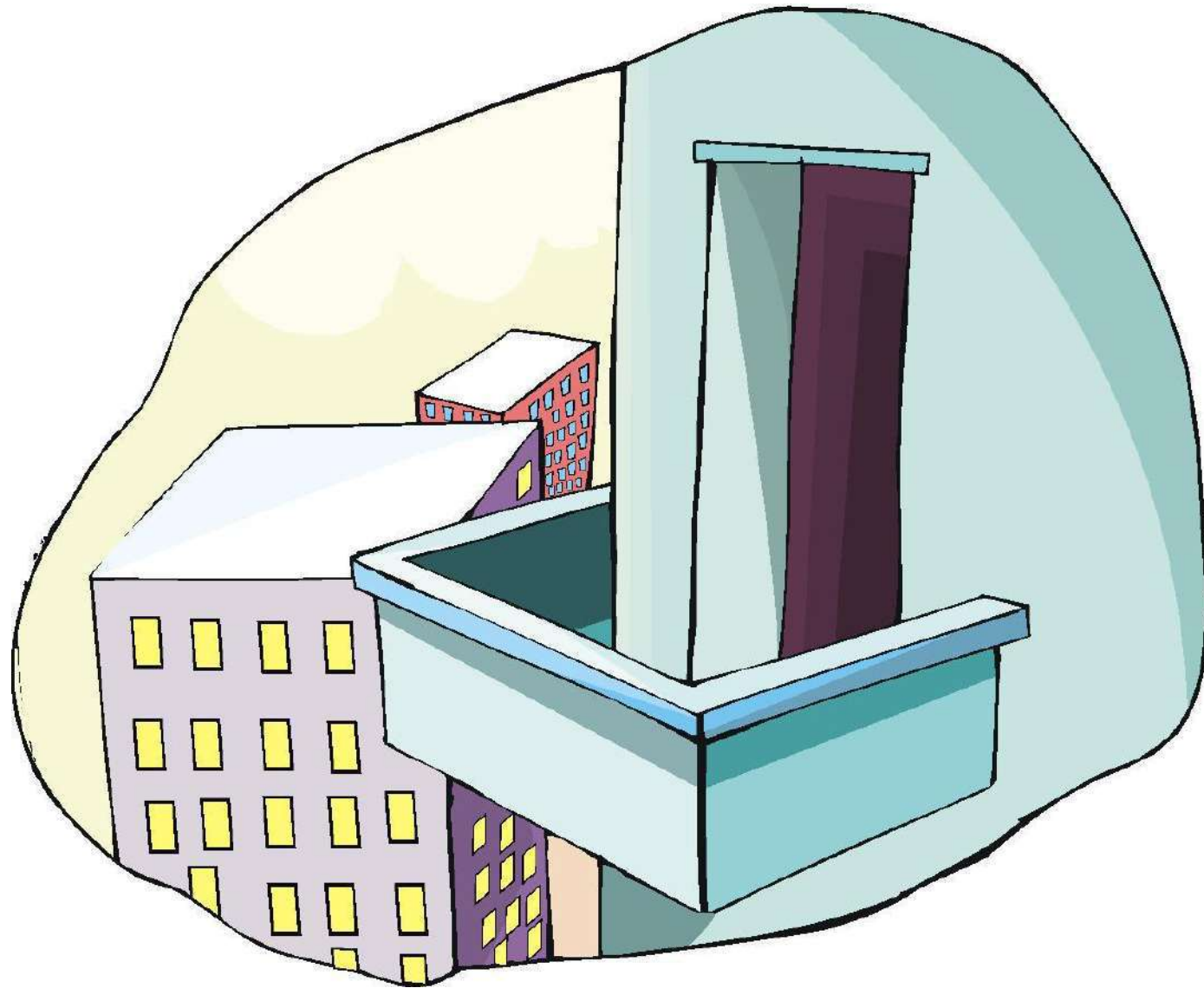









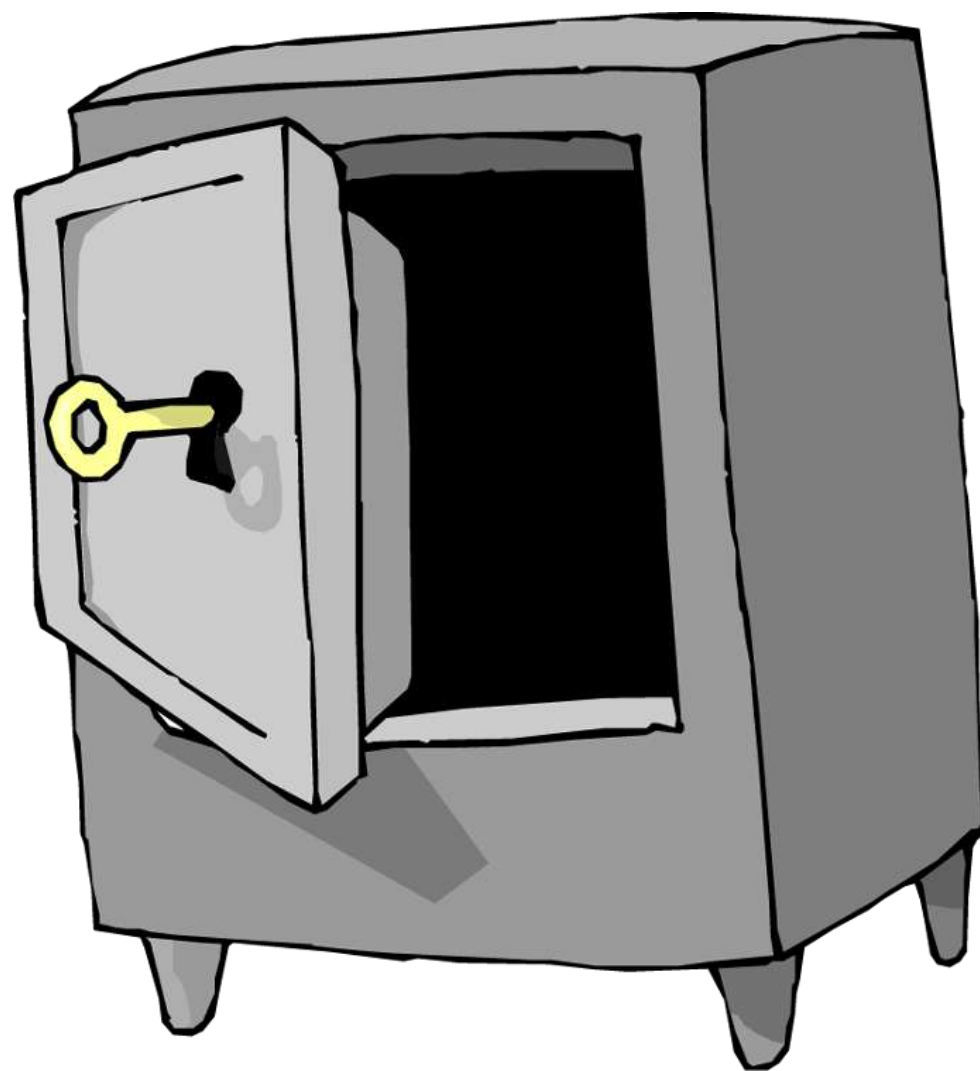





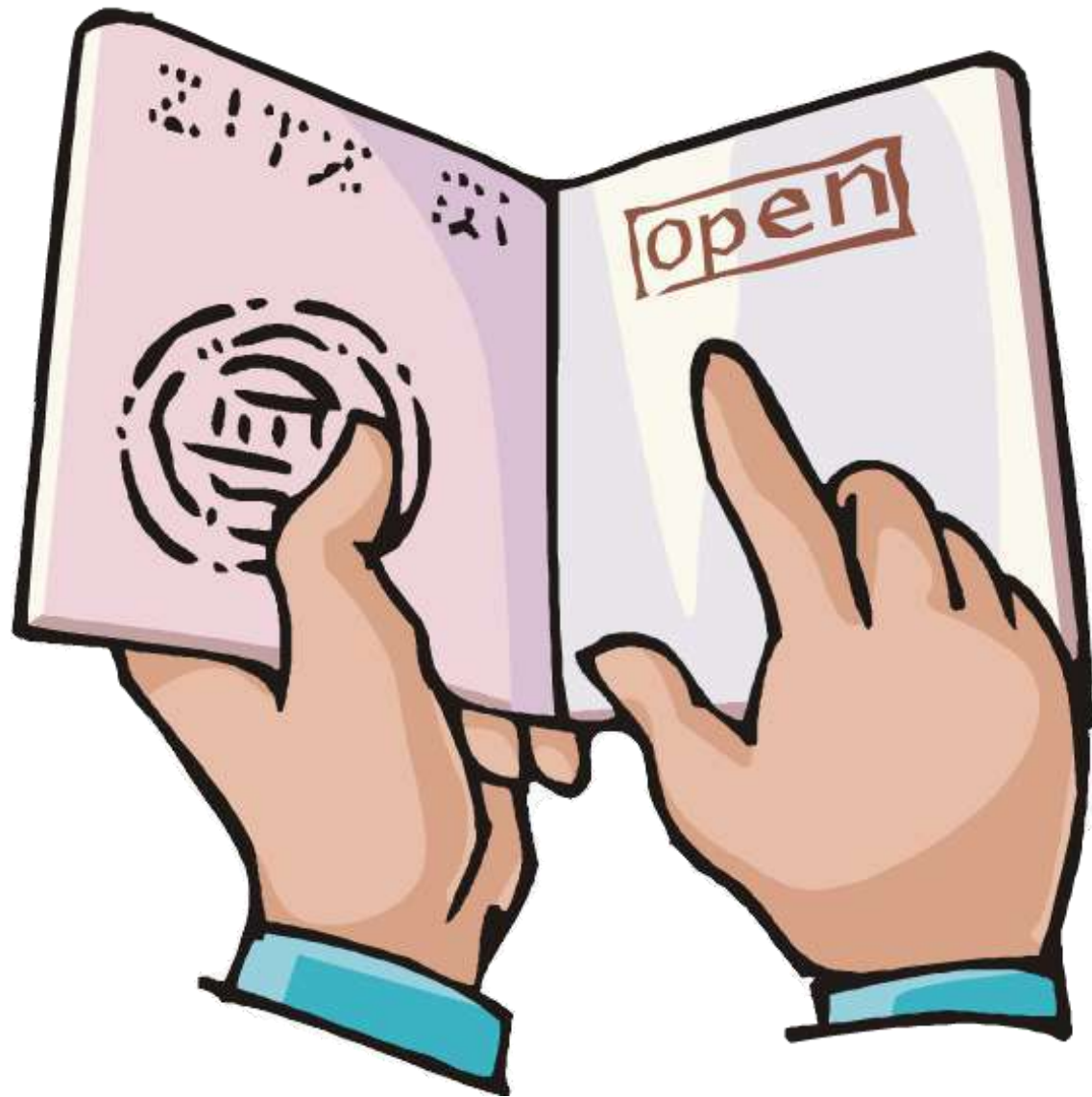

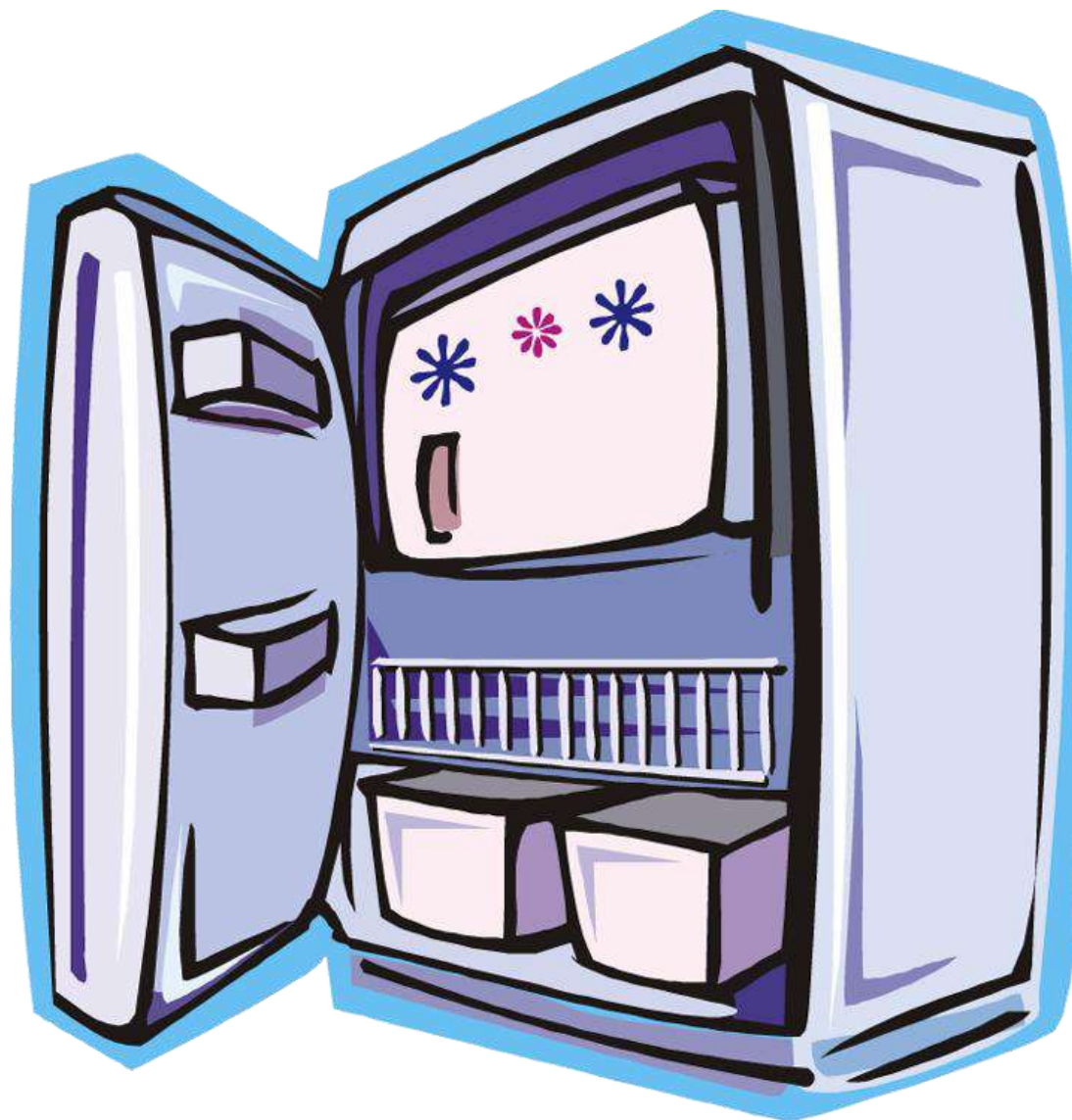



Copyright © 06/10/2019 englishsheets.com. All rights reserved.









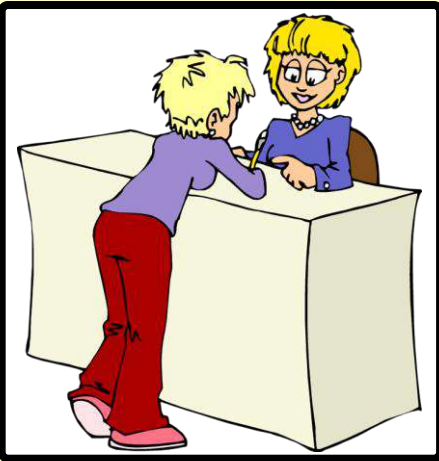

reception

Copyright © 06/10/2019 englishsheets.com. All rights reserved.



bellboy

Copyright © 06/10/2019 englishsheets.com. All rights reserved.



maid

Copyright © 06/10/2019 englishsheets.com. All rights reserved.



manager

Copyright © 06/10/2019 englishsheets.com. All rights reserved.



luggage

Copyright © 06/10/2019 englishsheets.com. All rights reserved.



key

Copyright © 06/10/2019 englishsheets.com. All rights reserved.

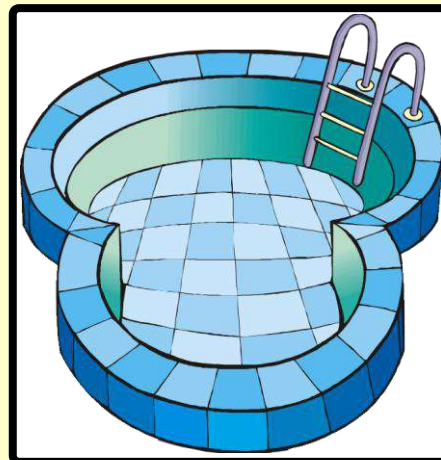

swimming pool

Copyright © 06/10/2019 englishsheets.com. All rights reserved.

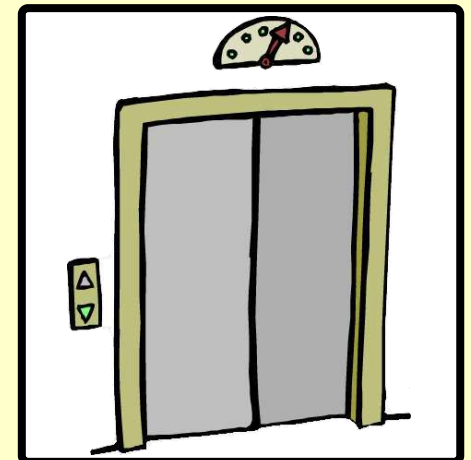

lift

Copyright © 06/10/2019 englishsheets.com. All rights reserved.



air conditioner

Copyright © 06/10/2019 englishsheets.com. All rights reserved.



sauna

Copyright © 06/10/2019 englishsheets.com. All rights reserved.

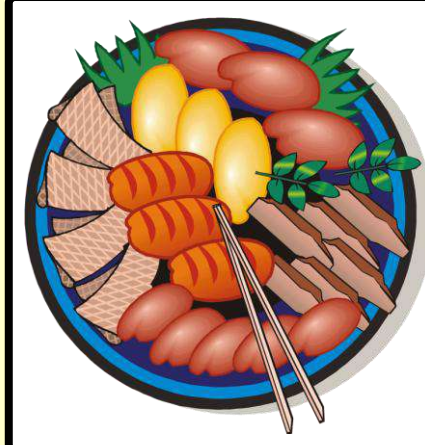

buffet

Copyright © 06/10/2019 englishsheets.com. All rights reserved.



gym

Copyright © 06/10/2019 englishsheets.com. All rights reserved.

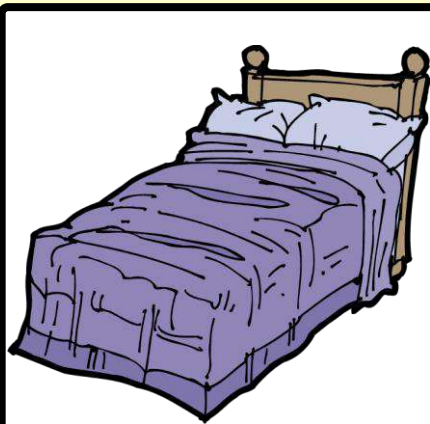

double bed

Copyright © 06/10/2019 englishsheets.com. All rights reserved.



single bed

Copyright © 06/10/2019 englishsheets.com. All rights reserved.

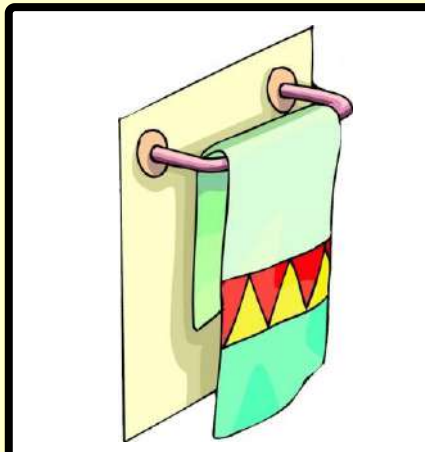

towel

Copyright © 06/10/2019 englishsheets.com. All rights reserved.

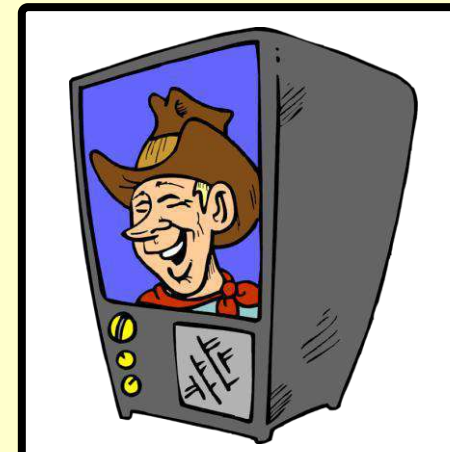

television

Copyright © 06/10/2019 englishsheets.com. All rights reserved.



lobby

Copyright © 06/10/2019 englishsheets.com. All rights reserved.

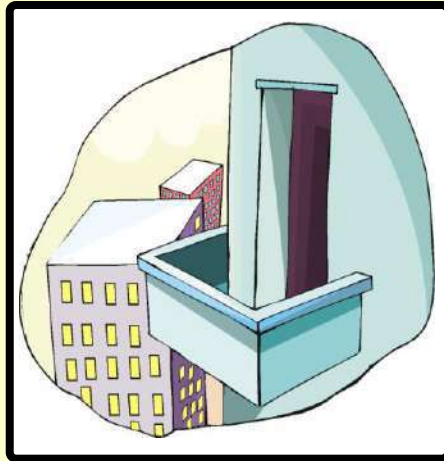

balcony

Copyright © 06/10/2019 englishsheets.com. All rights reserved.

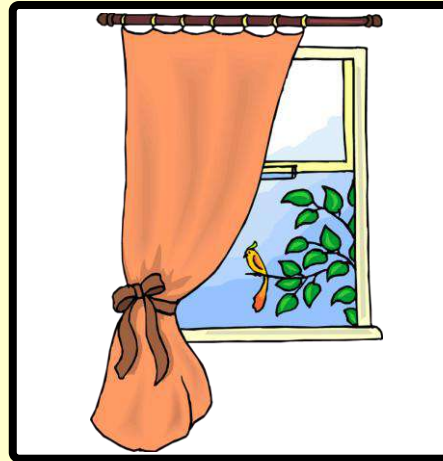

view

Copyright © 06/10/2019 englishsheets.com. All rights reserved.



brochure

Copyright © 06/10/2019 englishsheets.com. All rights reserved.



credit card

Copyright © 06/10/2019 englishsheets.com. All rights reserved.

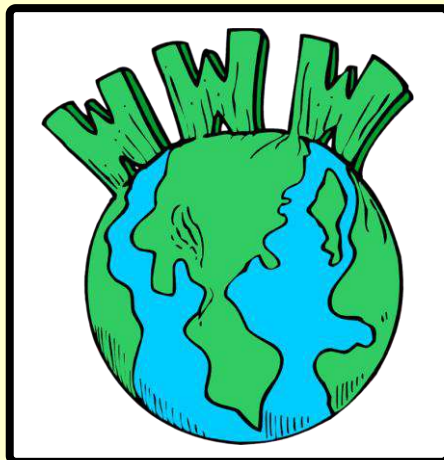

internet connection

Copyright © 06/10/2019 englishsheets.com. All rights reserved.

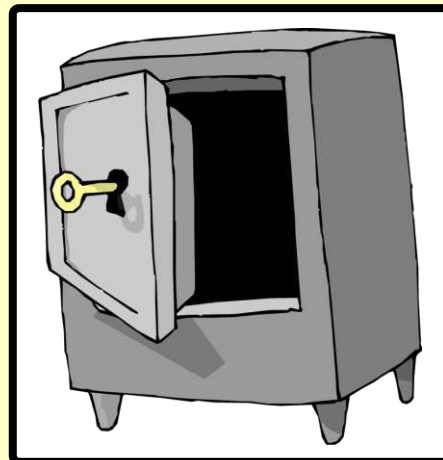

safe

Copyright © 06/10/2019 englishsheets.com. All rights reserved.



laundry

Copyright © 06/10/2019 englishsheets.com. All rights reserved.



tip

Copyright © 06/10/2019 englishsheets.com. All rights reserved.

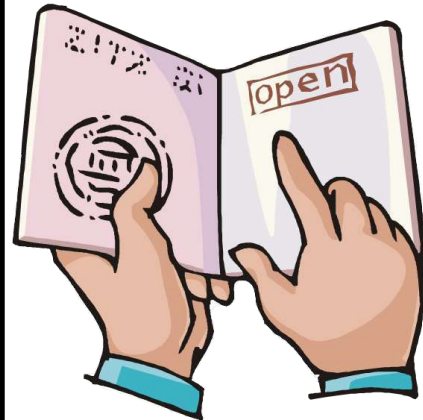

passport

Copyright © 06/10/2019 englishsheets.com. All rights reserved.

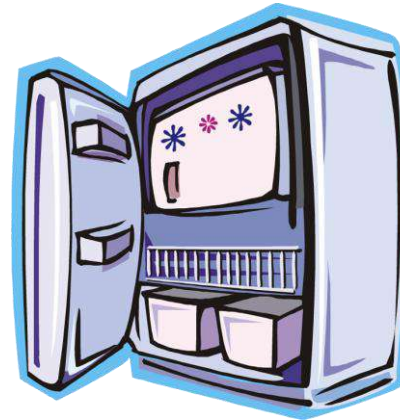

minibar

Copyright © 06/10/2019 englishsheets.com. All rights reserved.



bathtub

Copyright © 06/10/2019 englishsheets.com. All rights reserved.



hair dryer

Copyright © 06/10/2019 englishsheets.com. All rights reserved.

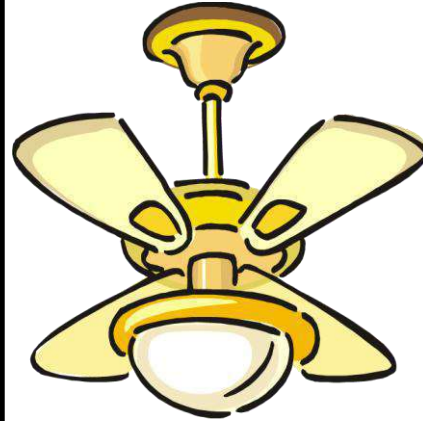

fan

Copyright © 06/10/2019 englishsheets.com. All rights reserved.



vending machine

Copyright © 06/10/2019 englishsheets.com. All rights reserved.



spa

Copyright © 06/10/2019 englishsheets.com. All rights reserved.

HOTEL FIDGET SPINNER GAME

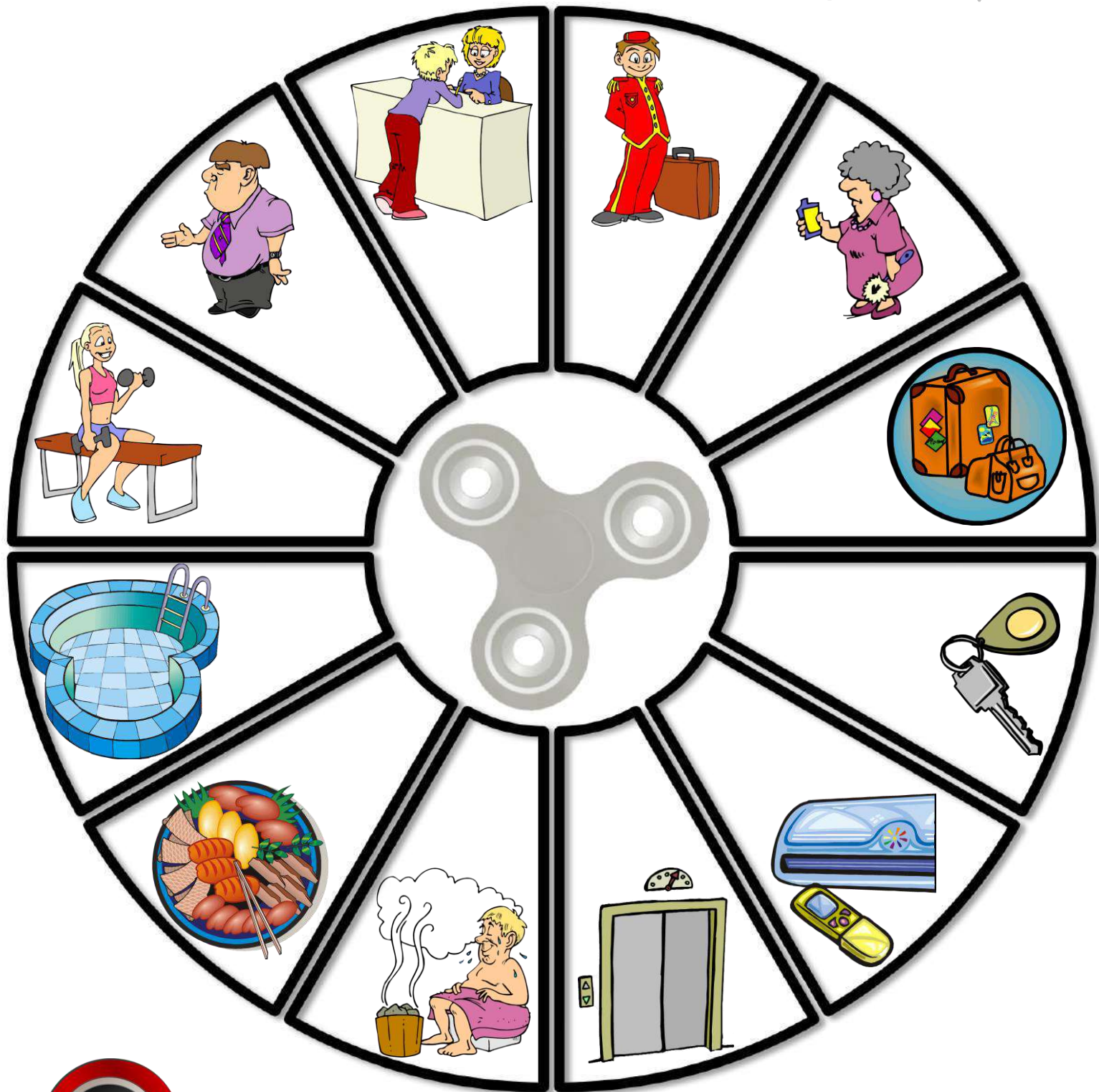

- Cut a small arrow from paper or craft foam and stick it onto the fidget spinner as your pointer.
- Place the fidget spinner in the middle of the vocabulary circle.
- Spin it and say the word quickly!

HOTEL FIDGET SPINNER GAME



- Cut a small arrow from paper or craft foam and stick it onto the fidget spinner as your pointer.
- Place the fidget spinner in the middle of the vocabulary circle.
- Spin it and say the word quickly!

HOTEL FIDGET SPINNER GAME

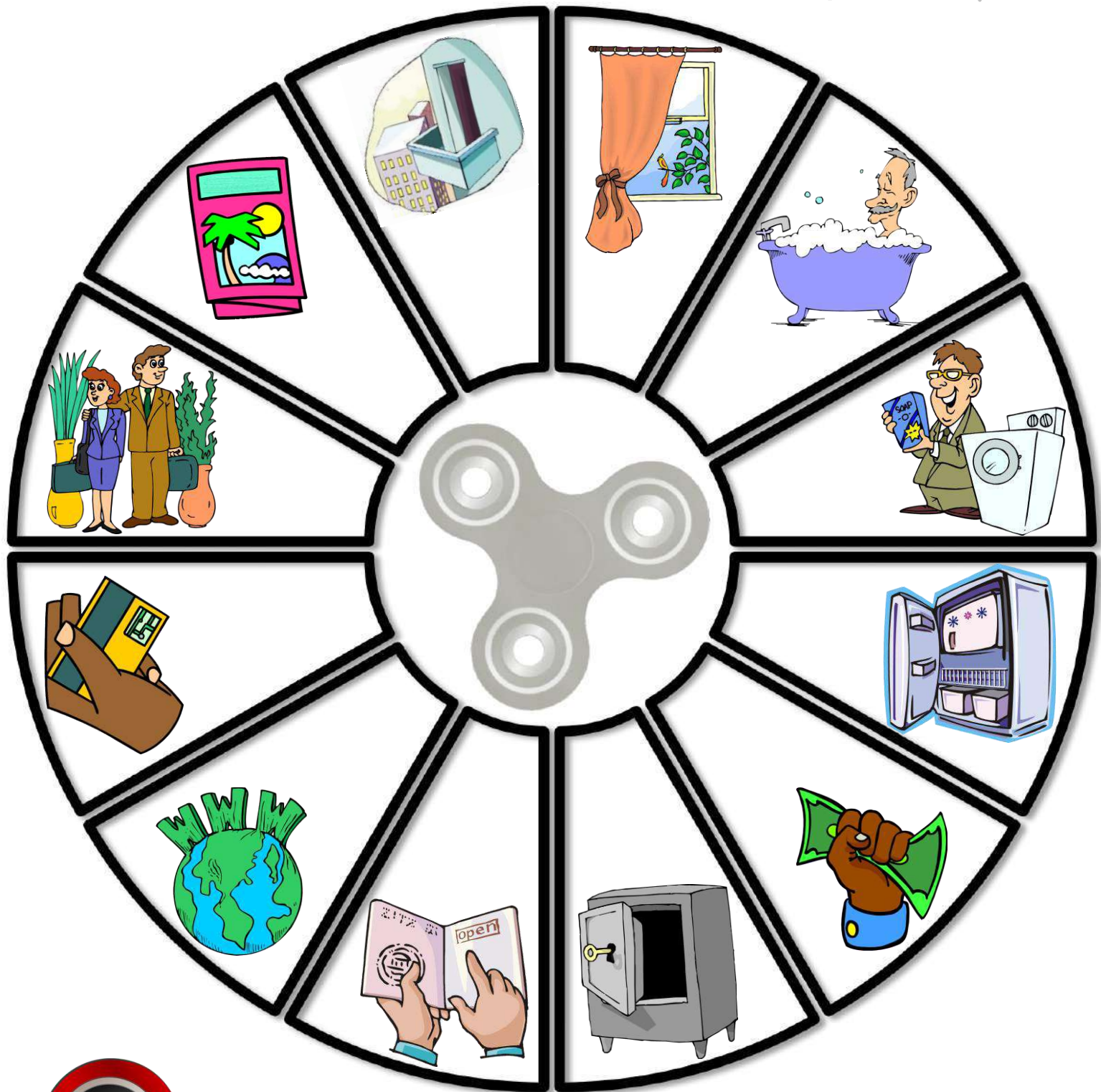

- Cut a small arrow from paper or craft foam and stick it onto the fidget spinner as your pointer.
- Place the fidget spinner in the middle of the vocabulary circle.
- Spin it and say the word quickly!

HOTEL FIDGET SPINNER GAME

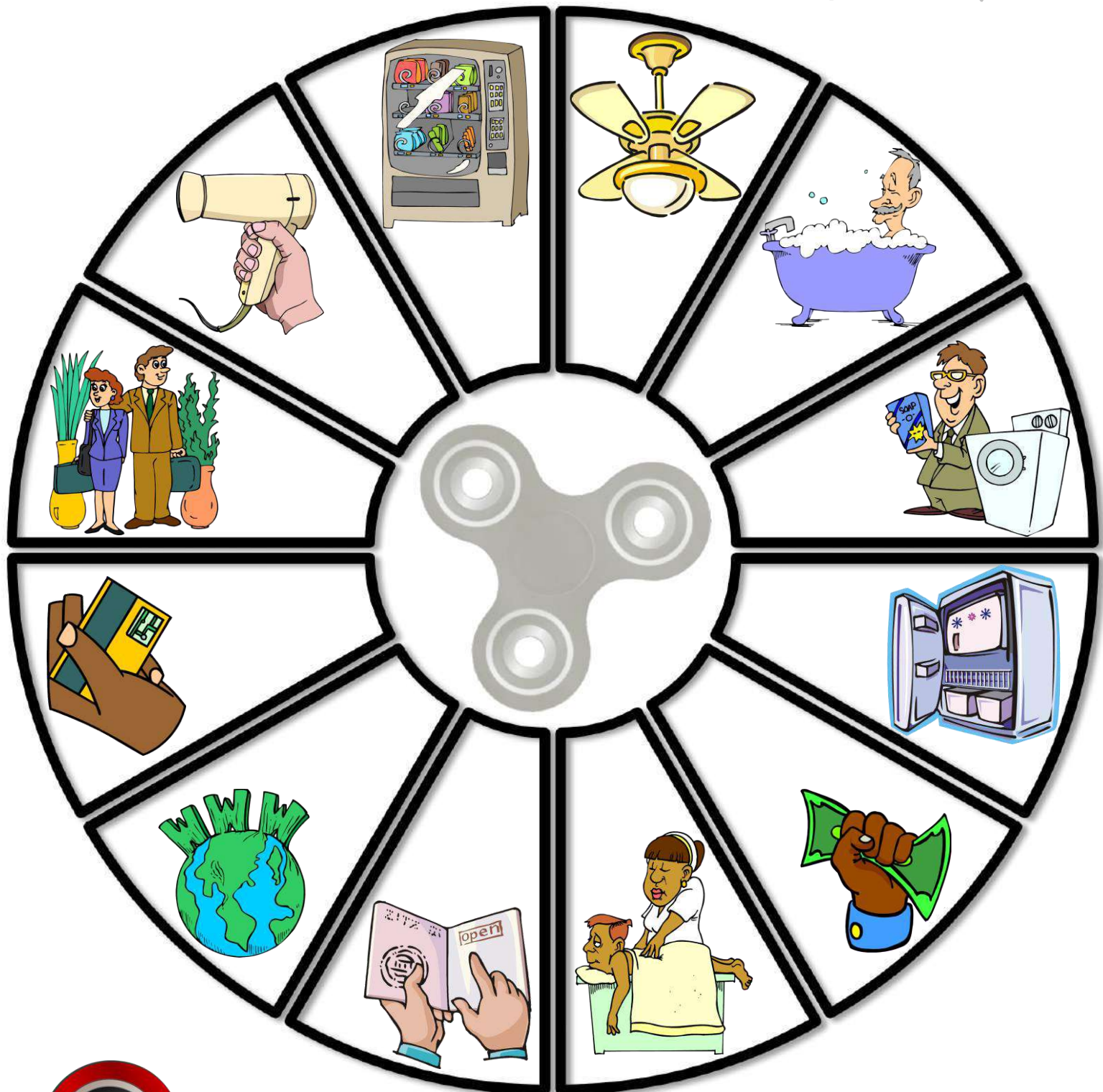

- Cut a small arrow from paper or craft foam and stick it onto the fidget spinner as your pointer.
- Place the fidget spinner in the middle of the vocabulary circle.
- Spin it and say the word quickly!

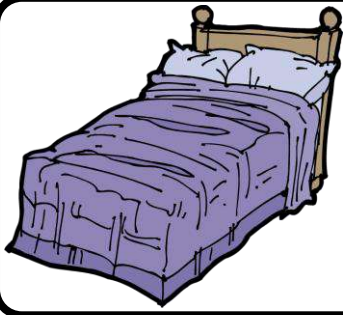

reception



bellboy



maid

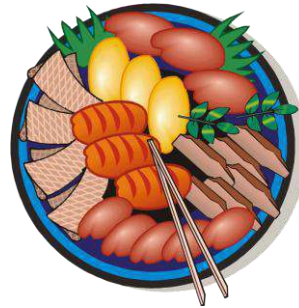

manager

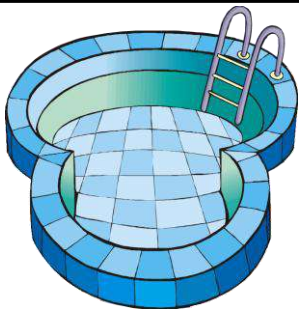

luggage



key



swimming
pool



lift

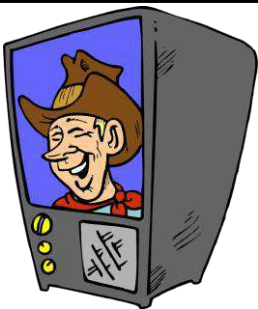

air conditioner



sauna



buffet



gym



double bed



single bed

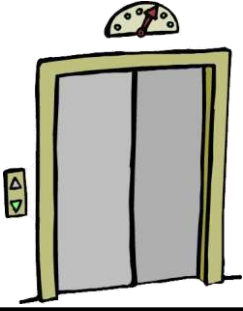

towel



television

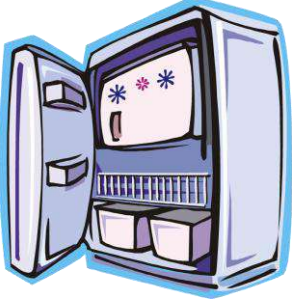

lobby



balcony



view

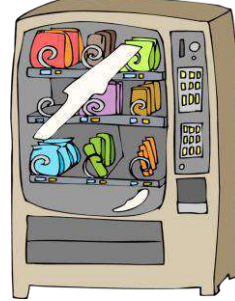

brochure

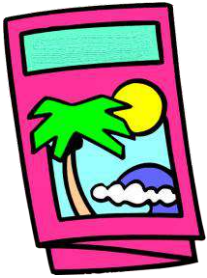

credit card

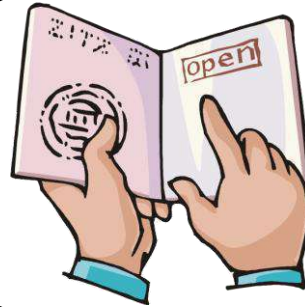

internet
connection



safe



laundry

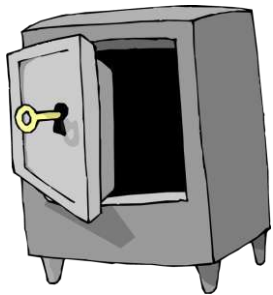

tip



passport



minibar

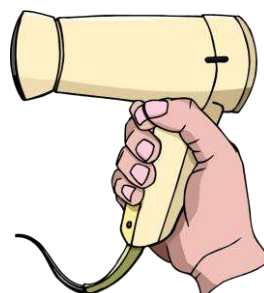

bathtub



hair dryer

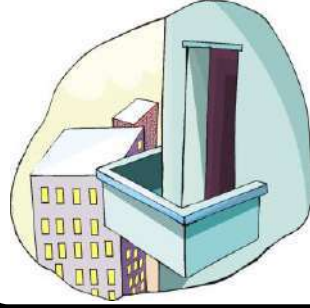

fan



vending
machine

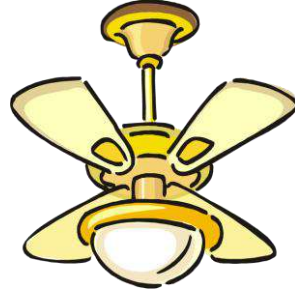

spa

HOUSEHOLD CHORES PICTURE DICTIONARY



wash the dishes



dust the furniture



vacuum the floor



mop the floor



do the ironing



sweep the floor



do the laundry



do the cooking



clean the windows



set the table



take out the trash



water the plants



feed the pets

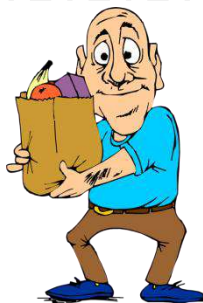

do the shopping



mow the lawn



fold the laundry



clean the toilet



do the gardening



wash the car



walk the dog

HOUSEHOLD CHORES PICTURE DICTIONARY



wash the dishes



dust the furniture



vacuum the floor



mop the floor



do the ironing



sweep the floor



do the laundry



do the cooking



clean the windows



set the table



take out the trash



water the plants



feed the pets



do the shopping



mow the lawn



fold the laundry



clean the toilet



do the gardening



wash the car



walk the dog

HOUSEHOLD CHORES VOCABULARY MATCHING WORKSHEET

Choose the correct words from the list below and write them under the correct pictures

- wash the dishes
- dust the furniture
- vacuum the floor
- mop the floor
- do the ironing

- sweep the floor
- do the laundry
- do the cooking
- clean the windows
- set the table

- take out the trash
- water the plants
- feed the pets
- do the shopping
- mow the lawn

- fold the laundry
- clean the toilet
- do the gardening
- wash the car
- walk the dog



HOUSEHOLD CHORES VOCABULARY MATCHING WORKSHEET ANSWER KEY

Choose the correct words from the list below and write them under the correct pictures

- wash the dishes
- dust the furniture
- vacuum the floor
- mop the floor
- do the ironing

- sweep the floor
- do the laundry
- do the cooking
- clean the windows
- set the table

- take out the trash
- water the plants
- feed the pets
- do the shopping
- mow the lawn

- fold the laundry
- clean the toilet
- do the gardening
- wash the car
- walk the dog



vacuum the floor



do the shopping



do the laundry



clean the windows



mow the lawn



do the cooking



water the plants



wash the dishes



sweep the floor



wash the car



take out the trash



clean the toilet



feed the pets



mop the floor



walk the dog



do the ironing



fold the laundry



do the gardening



dust the furniture



set the table

HOUSEHOLD CHORES WORD SEARCH PUZZLE

Find and circle the words in the word search puzzle and number the pictures

r	k	r	d	o	t	h	e	g	a	r	d	e	n	i	n	g	v	v	k
k	z	q	f	k	s	w	e	e	p	t	h	e	f	l	o	o	r	o	p
f	t	c	n	p	g	d	o	t	h	e	c	o	o	k	i	n	g	d	u
k	w	l	x	h	d	o	t	h	e	s	h	o	p	p	i	n	g	o	j
c	l	e	a	n	t	h	e	t	o	i	l	e	t	j	l	t	r	t	w
g	h	a	t	r	d	o	t	h	e	i	r	o	n	i	n	g	g	h	w
k	w	n	m	g	u	w	z	r	o	p	d	z	r	a	q	r	t	e	a
m	x	t	a	k	e	o	u	t	t	h	e	t	r	a	s	h	i	l	t
o	q	h	x	r	t	z	z	o	q	y	o	n	h	w	f	e	c	a	e
p	y	e	m	c	x	t	s	e	t	t	h	e	t	a	b	l	e	u	r
t	p	w	f	e	e	d	t	h	e	p	e	t	s	d	v	i	h	n	t
h	q	i	v	a	c	u	m	t	h	e	f	l	o	o	r	w	d	h	
e	v	n	w	a	s	h	t	h	e	c	a	r	w	o	i	m	d	r	e
f	y	d	c	w	a	l	k	t	h	e	d	o	g	w	u	d	r	y	p
l	u	o	p	q	k	h	b	t	b	s	e	y	y	j	m	d	a	g	l
o	k	w	x	k	b	m	o	w	t	h	e	l	a	w	n	c	f	y	a
o	h	s	f	o	l	d	t	h	e	l	a	u	n	d	r	y	v	r	n
r	e	f	d	u	s	t	t	h	e	f	u	r	n	i	t	u	r	e	t
y	v	w	a	s	h	t	h	e	d	i	s	h	e	s	b	x	k	c	s
r	a	c	l	h	d	r	v	f	j	b	g	d	t	l	q	w	r	c	c

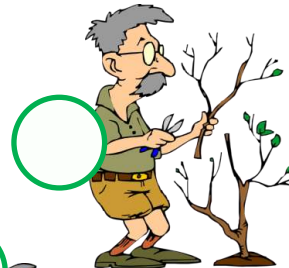
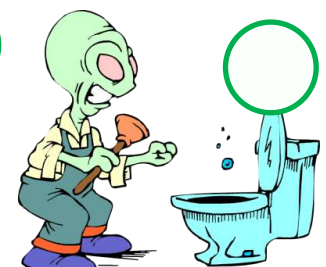
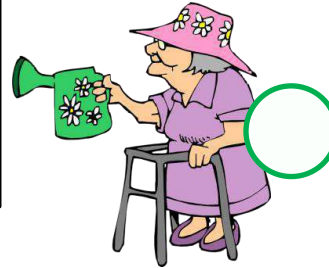

1. wash the dishes
2. dust the furniture
3. vacuum the floor
4. mop the floor
5. do the ironing
6. sweep the floor
7. do the laundry
8. do the cooking
9. clean the windows
10. set the table
11. take out the trash
12. water the plants
13. feed the pets
14. do the shopping
15. mow the lawn
16. fold the laundry
17. clean the toilet
18. do the gardening
19. wash the car
20. walk the dog



HOUSEHOLD CHORES WORD SEARCH PUZZLE ANSWER KEY

Find and circle the words in the word search puzzle and number the pictures

r	k	r	d	o	t	h	e	g	a	r	d	e	n	i	n	g	v	v	k
k	z	q	f	k	s	w	e	e	p	t	h	e	f	l	o	o	r	o	p
f	t	c	n	p	g	d	o	t	h	e	c	o	o	k	i	n	g	d	u
k	w	l	x	h	d	o	t	h	e	s	h	o	p	p	i	n	g	o	j
c	l	e	a	n	t	h	e	t	o	i	l	e	t	j	l	t	r	t	w
g	h	a	t	r	d	o	t	h	e	i	r	o	n	i	n	g	g	h	w
k	w	n	m	g	u	w	z	r	o	p	d	z	r	a	q	r	t	e	a
m	x	t	a	k	e	o	u	t	t	h	e	t	r	a	s	h	i	l	t
o	q	h	x	r	t	z	z	o	q	y	o	n	h	w	f	e	c	a	e
p	y	e	m	c	x	t	s	e	t	t	h	e	t	a	b	l	e	u	r
t	p	w	f	e	e	d	t	h	e	p	e	t	s	d	v	i	h	n	t
h	q	i	v	a	c	u	m	t	h	e	f	l	o	o	r	w	d	h	
e	v	n	w	a	s	h	t	h	e	c	a	r	w	o	i	m	d	r	e
f	y	d	c	w	a	k	t	h	e	d	o	g	w	u	d	r	y	p	
l	u	o	p	q	k	h	b	t	b	s	e	y	y	j	m	d	a	g	l
o	k	w	x	k	b	m	o	w	t	h	e	l	a	w	n	c	f	y	a
o	h	s	f	o	l	d	t	h	e	l	a	u	n	d	r	y	v	r	n
r	e	f	d	u	s	t	t	h	e	f	u	r	n	i	t	u	r	e	t
y	v	w	a	s	h	t	h	e	d	i	s	h	e	s	b	x	k	c	s
r	a	c	l	h	d	r	v	f	j	b	g	d	t	l	q	w	r	c	c

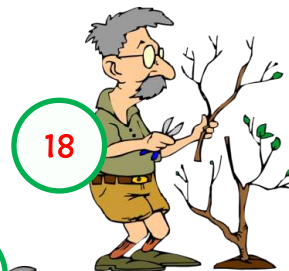
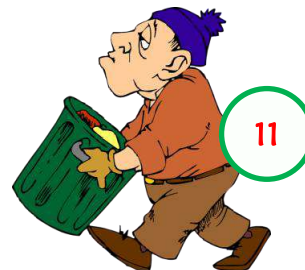
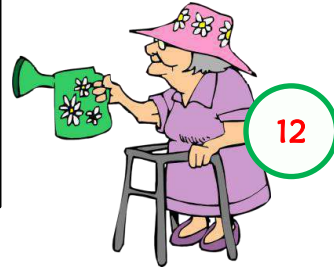

1. wash the dishes
2. dust the furniture
3. vacuum the floor
4. mop the floor
5. do the ironing
6. sweep the floor
7. do the laundry
8. do the cooking
9. clean the windows
10. set the table
11. take out the trash
12. water the plants
13. feed the pets
14. do the shopping
15. mow the lawn
16. fold the laundry
17. clean the toilet
18. do the gardening
19. wash the car
20. walk the dog



HOUSEHOLD CHORES CROSSWORD PUZZLE !

Look at the numbers on the pictures and write the household chores vocabulary in the crossword puzzle

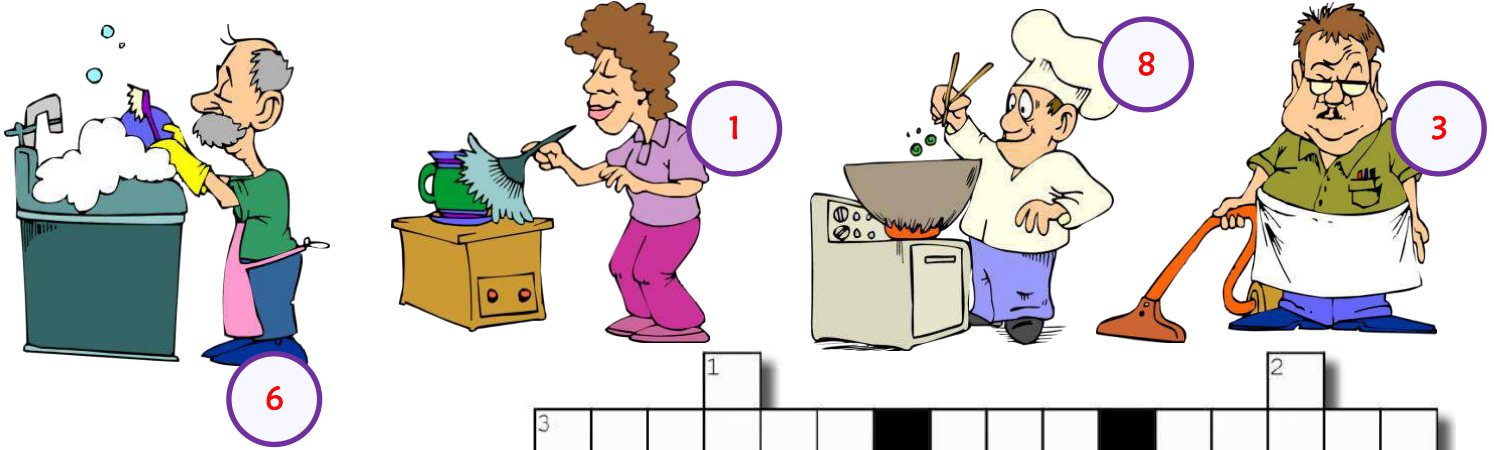

ANSWER KEY

Across

3. vacuum the floor

5. clean the windows

6. wash the dishes

7. sweep the floor

8. do the cooking

9. set the table

10. do the ironing

Down

1. dust the furniture

2. do the laundry

4. mop the floor

HOUSEHOLD CHORES CROSSWORD PUZZLE 2

Look at the numbers on the pictures and write the household chores vocabulary in the crossword puzzle

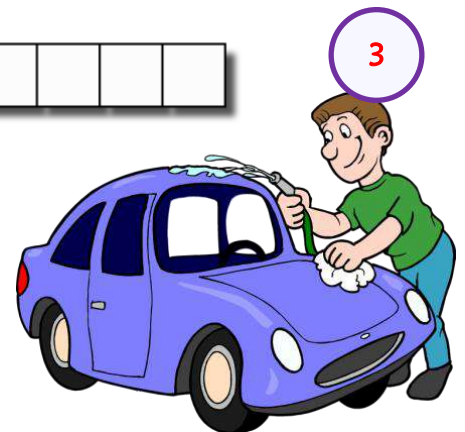
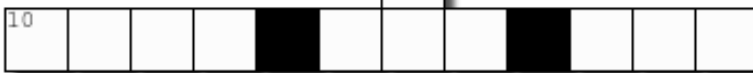
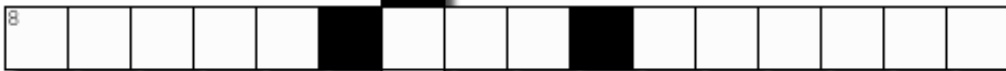
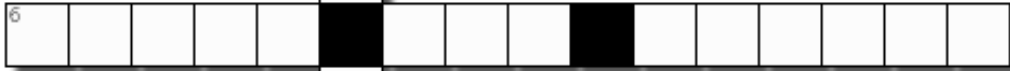
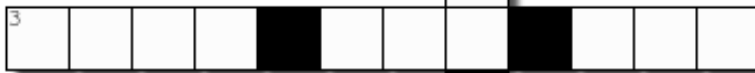
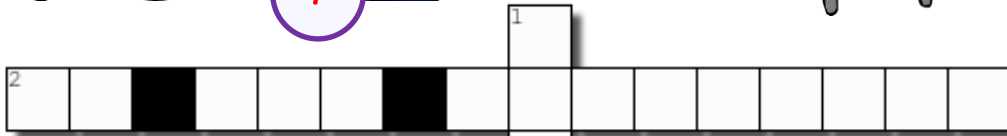

ANSWER KEY

Across

2. do the gardening

3. wash the car

4. do the shopping

6. water the plants

7. feed the pets

8. clean the toilet

9. fold the laundry

10. walk the dog

Down

1. take out the trash

5. mow the lawn

HOUSEHOLD CHORES MISSING LETTERS IN WORDS

Write the missing letters in the boxes to complete the household chores vocabulary

w_sh the d_sh_s



v_c_m the fl_r



d_st the f_rn_t_r_



m_p the fl_r



sw_p the fl_r



d_ the _r_n_ng



d_ the l_ndry



d_ the c_k_ng



s_t the t_bl_



t_k_o_t the tr_sh



cl_n the w_nd_ws



f_d the p_ts



f_ld the l_ndry



m_w the l_wn



w_t_r the pl_nts



d_ the sh_pp_ng



cl_n the t_l_t



w_lk the d_g



d_ the g_rd_n_ng



w_sh the c_r



HOUSEHOLD CHORES MISSING LETTERS IN WORDS ANSWER KEY

Write the missing letters in the boxes to complete the household chores vocabulary

wash the dishes



vacuum the floor



dust the furniture



mop the floor



sweep the floor



do the ironing



do the laundry



do the cooking



set the table



take out the trash



clean the windows



feed the pets



fold the laundry



mow the lawn



water the plants



do the shopping



clean the toilet

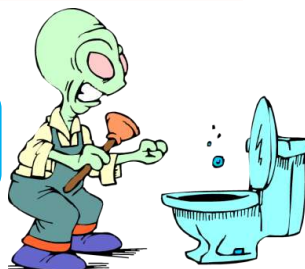

wak the dog



do the gardening



wash the car



HOUSEHOLD CHORES UNSCRAMBLE THE WORDS

Unscramble the household chores vocabulary and number the pictures

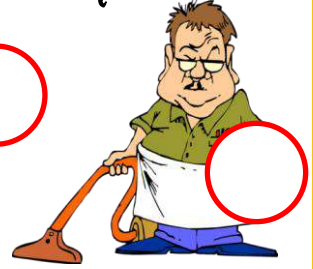
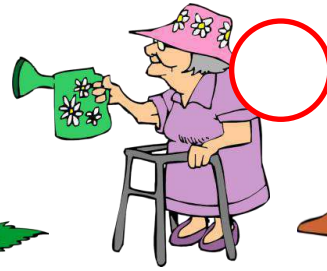
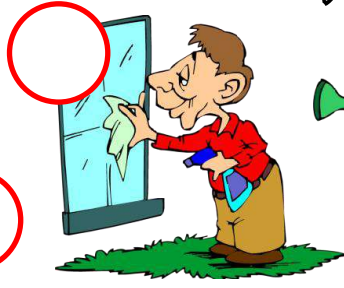
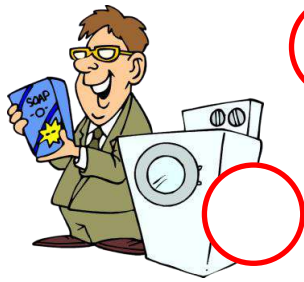
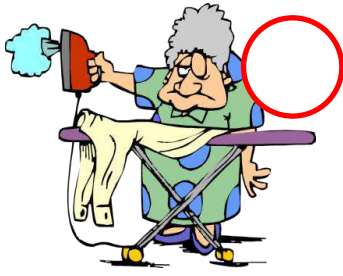

1. hwsa the hdssie _____
2. teka uto eht trsah _____
3. udst teh nrefruitut _____



4. ewatr hte tanlsp _____
5. uvamcu the ofrol _____
6. eefd eht pest _____



7. omp eth folro _____
8. od eht osgpinph _____
9. od het inigron _____



10. omw the nalw _____
11. esewp eht floro _____
12. dolf eht anydrlu _____

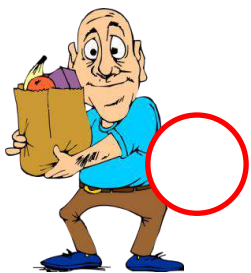
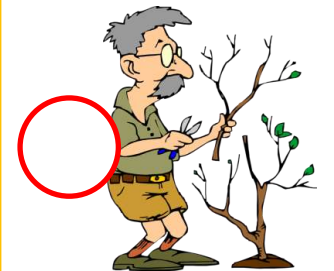

13. do eth lunyrad _____
14. aecnl the ttiel _____
15. od eth cnooikg _____

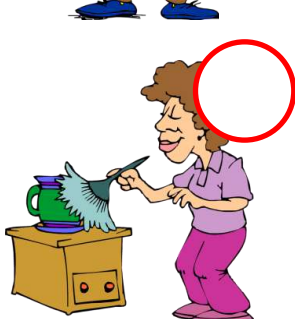

16. do het ridgganen _____
17. acenl eth nwiowds _____
18. shwa teh car _____

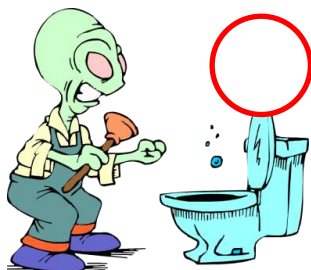

19. ste hte lateb _____
20. wkal hte god _____

HOUSEHOLD CHORES UNSCRAMBLE THE WORDS ANSWER KEY

Unscramble the household chores vocabulary and number the pictures

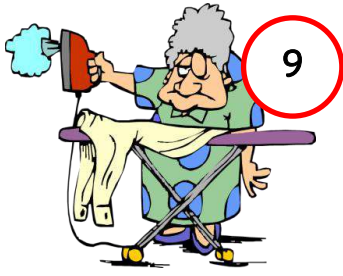

9



13



17

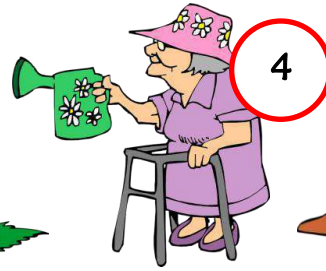

4

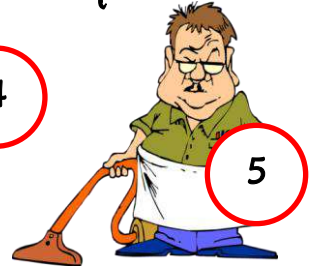

5



15



11



12



2



8



3



14



6



18



19

1. hwsa the hdssie
2. teka uto eht trsah
3. udst teh nrefruit
4. ewatr hte tanlsp
5. uvamcu the ofrol
6. eefd eht pest
7. omp eth folro
8. od eht osgpinph
9. od het inigron
10. omw the nalw
11. esewp eht floro
12. dolf eht anydrlu
13. do eth lunyrad
14. aecnl the ttiel
15. od eth cnooikg
16. do het ridgganen
17. acenl eth nwiowds
18. shwa teh car
19. ste hte lateb
20. wkal hte god

- wash the dishes
- take out the trash
- dust the furniture
- water the plants
- vacuum the floor
- feed the pets
- mop the floor
- do the shopping
- do the ironing
- mow the lawn
- sweep the floor
- fold the laundry
- do the laundry
- clean the toilet
- do the cooking
- do the gardening
- clean the windows
- wash the car
- set the table
- walk the dog



1



7



10

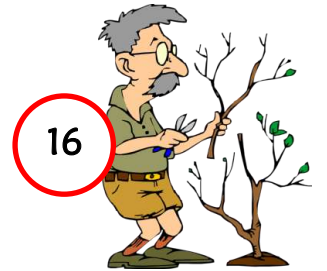

16



20

HOUSEHOLD CHORES MULTIPLE CHOICE TEST

Look at the pictures, choose and circle the correct option.



- 1
- a) sweep the floor
 - b) wash the dishes
 - c) take out the trash



- 2
- a) dust the furniture
 - b) water the plants
 - c) do the cooking



- 3
- a) do the ironing
 - b) set the table
 - c) vacuum the floor



- 4
- a) mop the floor
 - b) do the laundry
 - c) clean the windows

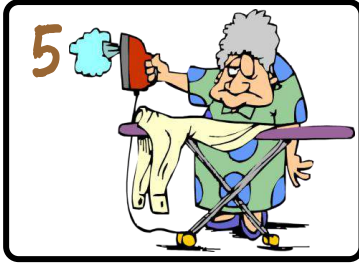

- 5
- a) set the table
 - b) mow the lawn
 - c) do the ironing



- 6
- a) take out the trash
 - b) sweep the floor
 - c) fold the laundry



- 7
- a) do the laundry
 - b) clean the windows
 - c) feed the pets



- 8
- a) water the plants
 - b) do the cooking
 - c) do the shopping



- 9
- a) clean the windows
 - b) do the shopping
 - c) walk the dog



- 10
- a) feed the pets
 - b) set the table
 - c) wash the car



- 11
- a) fold the laundry
 - b) take out the trash
 - c) do the gardening



- 12
- a) clean the toilet
 - b) mow the lawn
 - c) water the plants

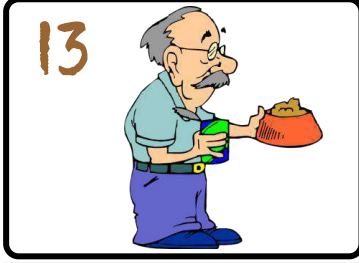

- 13
- a) mop the floor
 - b) wash the car
 - c) feed the pets

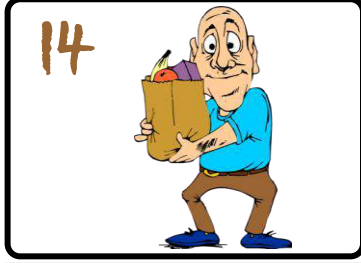

- 14
- a) do the shopping
 - b) walk the dog
 - c) vacuum the floor

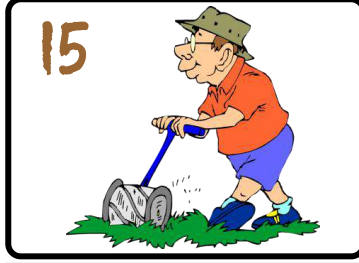

- 15
- a) mow the lawn
 - b) clean the toilet
 - c) wash the dishes



- 16
- a) do the gardening
 - b) fold the laundry
 - c) dust the furniture

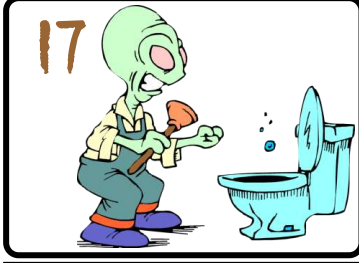

- 17
- a) do the laundry
 - b) vacuum the floor
 - c) clean the toilet



- 18
- a) wash the dishes
 - b) do the gardening
 - c) do the cooking



- 19
- a) wash the car
 - b) sweep the floor
 - c) dust the furniture



- 20
- a) vacuum the floor
 - b) walk the dog
 - c) do the ironing

HOUSEHOLD CHORES MULTIPLE CHOICE TEST ANSWER KEY

TEST 1

- 1) b
- 2) a
- 3) c
- 4) a
- 5) c
- 6) b
- 7) a
- 8) b
- 9) a
- 10) b
- 11) b
- 12) c
- 13) c
- 14) a
- 15) a
- 16) b
- 17) c
- 18) b
- 19) a
- 20) b



wash the dishes



dust the furniture



vacuum the floor



mop the floor



do the ironing



sweep the floor



do the laundry



do the cooking



clean the windows



set the table



take out the trash



water the plants



feed the pets

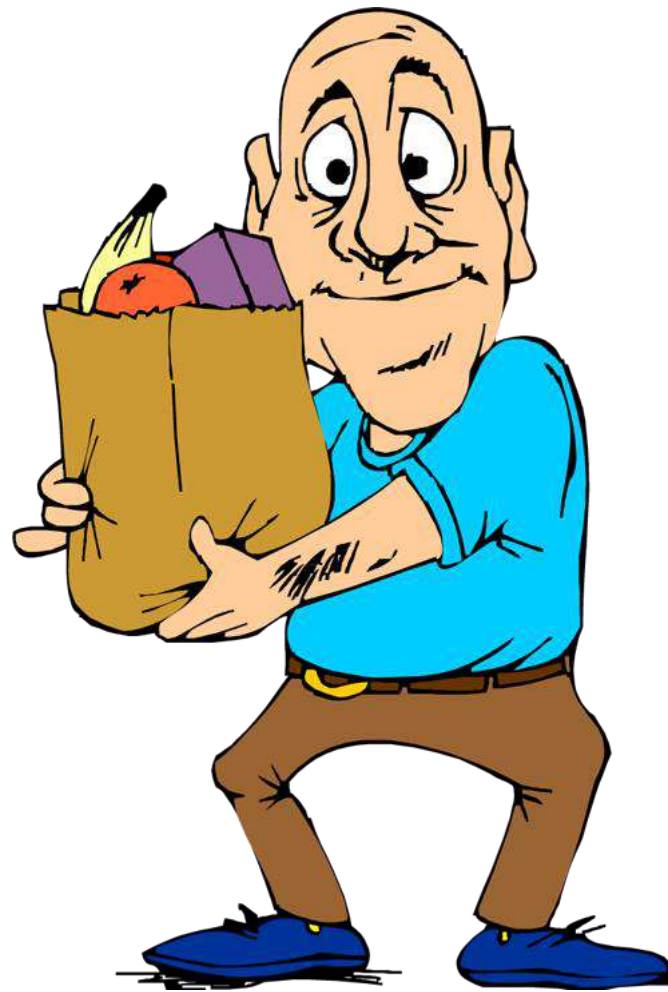

do the shopping



mow the lawn



fold the laundry



clean the toilet



do the gardening



wash the car



walk the dog



























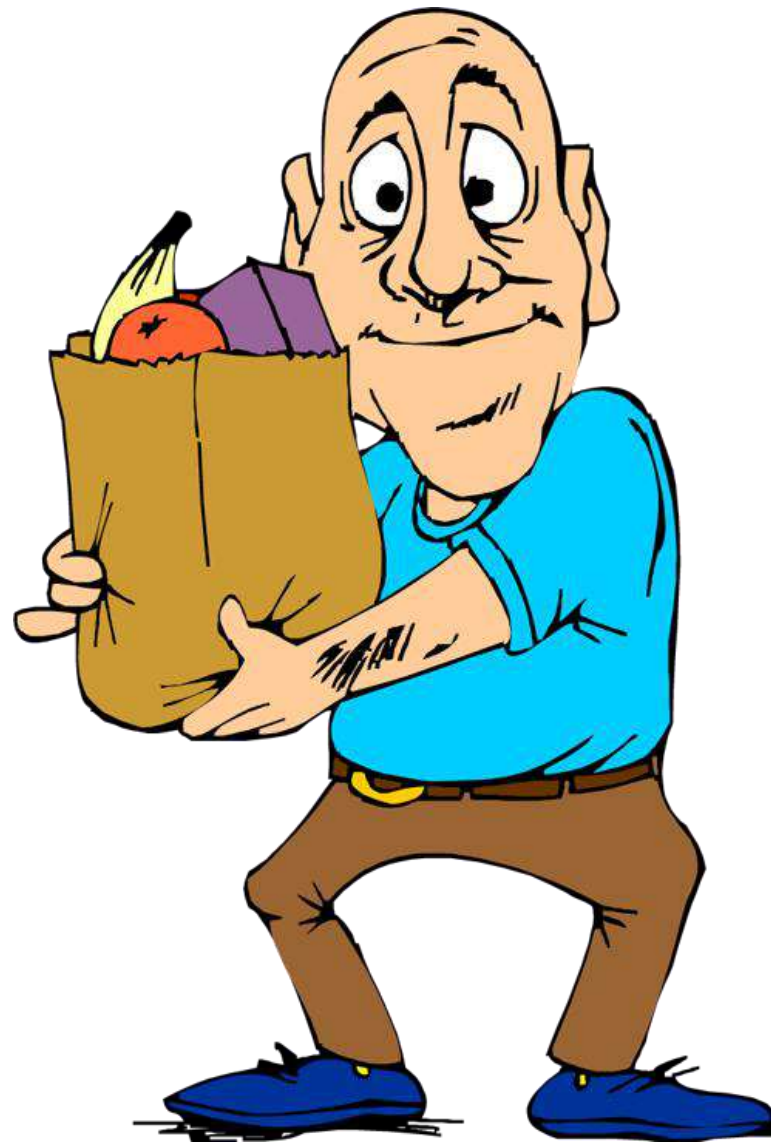







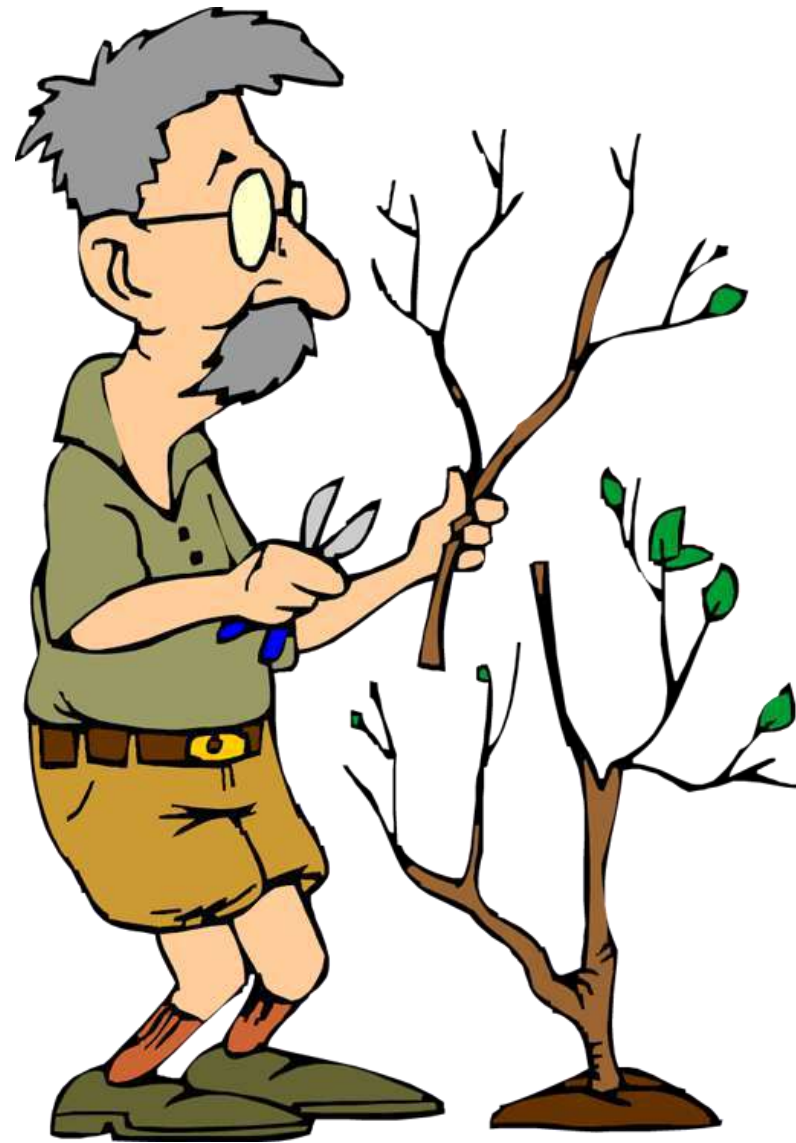







wash the dishes

Copyright © 29/04/2020 englishsheets.com. All rights reserved.



dust the furniture

Copyright © 29/04/2020 englishsheets.com. All rights reserved.



vacuum the floor

Copyright © 29/04/2020 englishsheets.com. All rights reserved.



mop the floor

Copyright © 29/04/2020 englishsheets.com. All rights reserved.



do the ironing

Copyright © 29/04/2020 englishsheets.com. All rights reserved.



sweep the floor

Copyright © 29/04/2020 englishsheets.com. All rights reserved.



do the laundry

Copyright © 29/04/2020 englishsheets.com. All rights reserved.



do the cooking

Copyright © 29/04/2020 englishsheets.com. All rights reserved.



clean the windows

Copyright © 29/04/2020 englishsheets.com. All rights reserved.



set the table

Copyright © 29/04/2020 englishsheets.com. All rights reserved.



take out the trash

Copyright © 29/04/2020 englishsheets.com. All rights reserved.

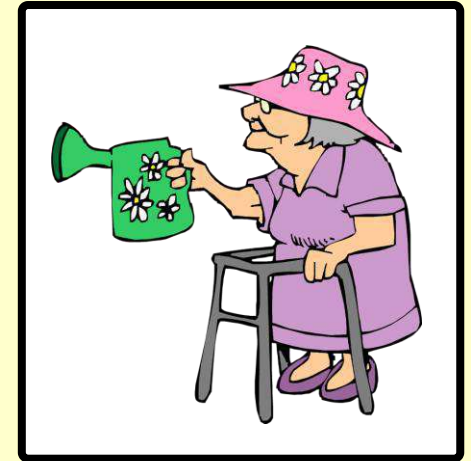

water the plants

Copyright © 29/04/2020 englishsheets.com. All rights reserved.

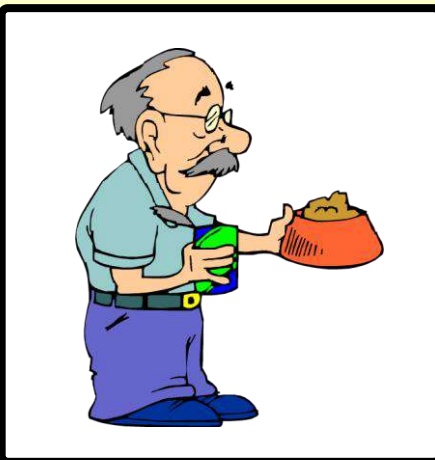

feed the pets

Copyright © 29/04/2020 englishsheets.com. All rights reserved.

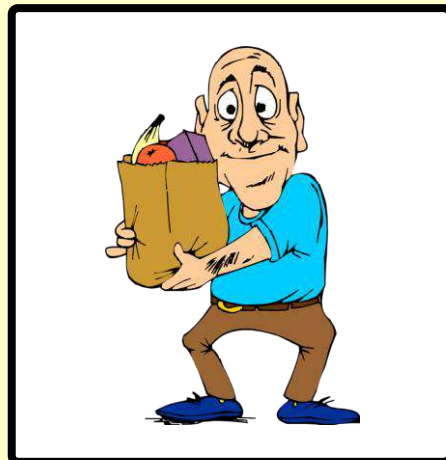

do the shopping

Copyright © 29/04/2020 englishsheets.com. All rights reserved.

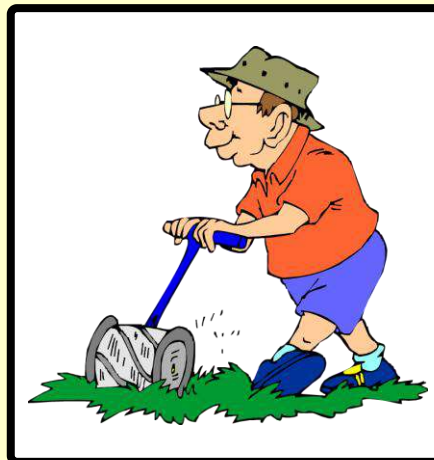

mow the lawn

Copyright © 29/04/2020 englishsheets.com. All rights reserved.



fold the laundry

Copyright © 29/04/2020 englishsheets.com. All rights reserved.



clean the toilet

Copyright © 29/04/2020 englishsheets.com. All rights reserved.



do the gardening

Copyright © 29/04/2020 englishsheets.com. All rights reserved.

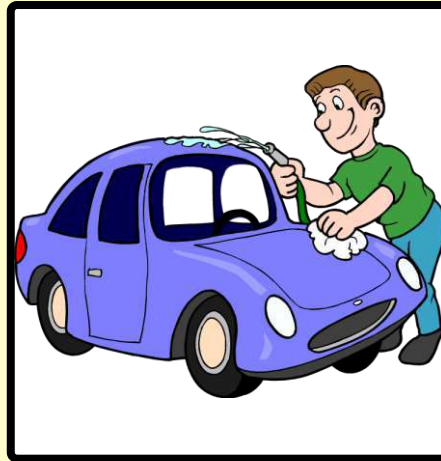

wash the car

Copyright © 29/04/2020 englishsheets.com. All rights reserved.



walk the dog

Copyright © 29/04/2020 englishsheets.com. All rights reserved.

HOUSEHOLD CHORES FIDGET SPINNER GAME



- Cut a small arrow from paper or craft foam and stick it onto the fidget spinner as your pointer.
- Place the fidget spinner in the middle of the vocabulary circle.
- Spin it and say the word quickly!

HOUSEHOLD CHORES FIDGET SPINNER GAME



- Cut a small arrow from paper or craft foam and stick it onto the fidget spinner as your pointer.
- Place the fidget spinner in the middle of the vocabulary circle.
- Spin it and say the word quickly!



wash the
dishes



dust the
furniture



vacuum the
floor



mop the floor



do the ironing



sweep the
floor



do the laundry



do the cooking



clean the
windows



set the table



take out the
trash



water the
plants



feed the pets



do the shopping



mow the lawn



fold the laundry



clean the toilet



do the gardening



wash the car



walk the dog

INSECTS PICTURE DICTIONARY

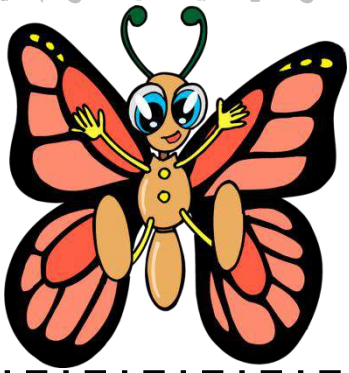

butterfly



bee

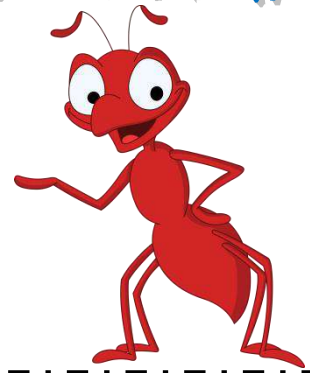

ant

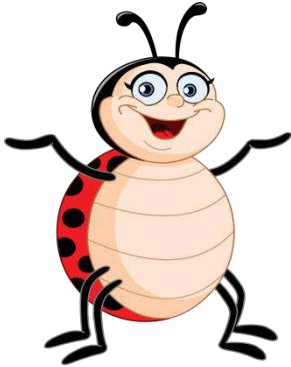

ladybug



mosquito



spider



caterpillar



wasp



grasshopper

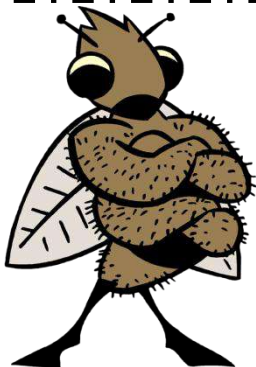

fly



dragonfly



firefly

INSECTS PICTURE DICTIONARY

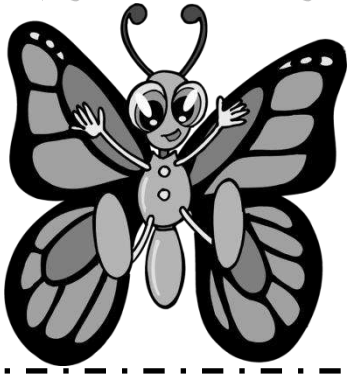

butterfly



bee

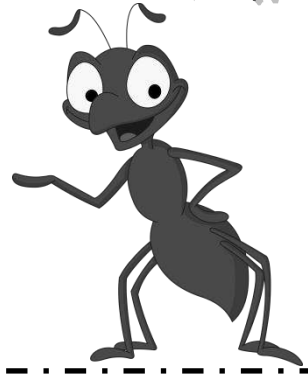

ant

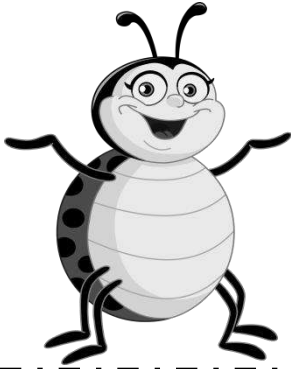

ladybug



mosquito

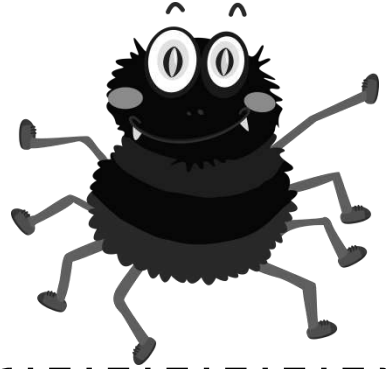

spider

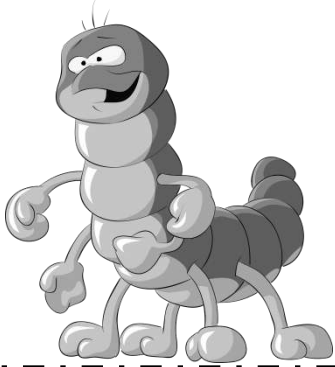

caterpillar



wasp



grasshopper

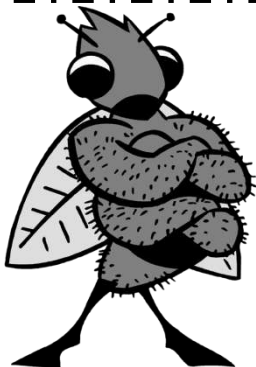

fly



dragonfly



firefly

INSECTS VOCABULARY MATCHING WORKSHEET

Choose the correct words from the list below and write them under the correct pictures

- butterfly
- bee
- ant
- ladybug

- mosquito
- spider
- caterpillar
- wasp

- grasshopper
- fly
- dragonfly
- firefly



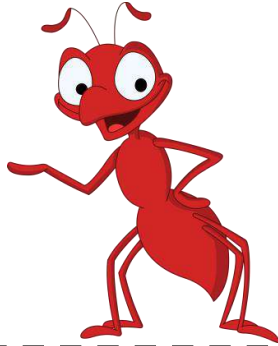







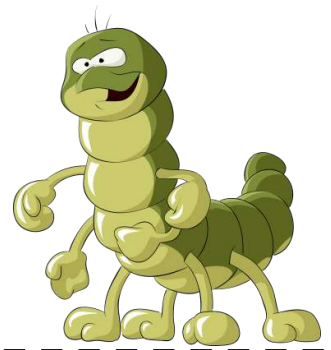





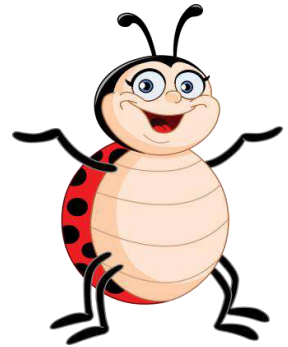

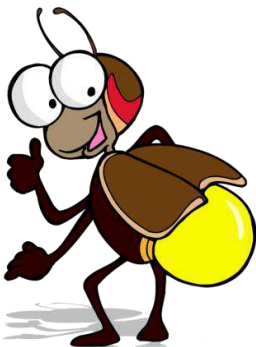

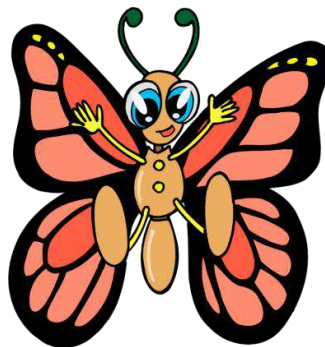



INSECTS VOCABULARY MATCHING WORKSHEET ANSWER KEY

Choose the correct words from the list below and write them under the correct pictures

- butterfly
- bee
- ant
- ladybug

- mosquito
- spider
- caterpillar
- wasp

- grasshopper
- fly
- dragonfly
- firefly



wasp

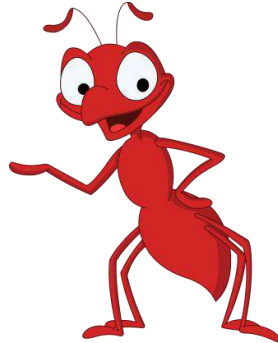

ant



dragonfly



mosquito



fly



caterpillar



bee



grasshopper

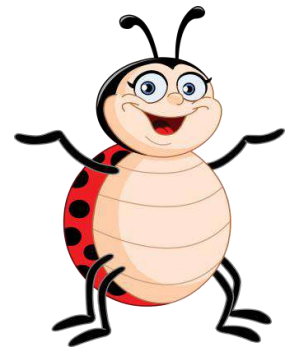

ladybug

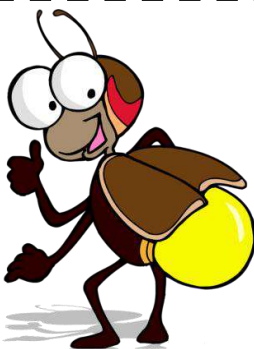

firefly

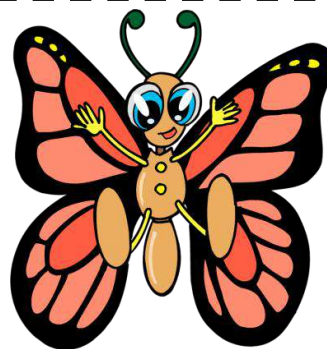

butterfly

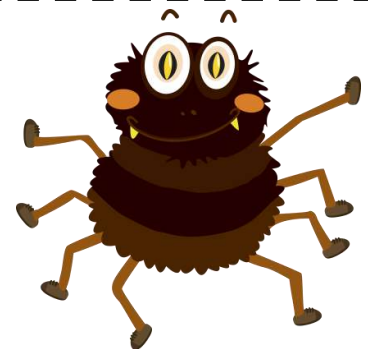

spider

INSECTS VOCABULARY WORD SEARCH PUZZLE

Find and circle the words in the word search puzzle and number the pictures

b	t	b	a	n	t	x	u	q	w	j	x	c	u	b	o	f	x	f	k
u	m	z	d	s	k	j	g	r	s	w	y	u	p	e	r	q	r	m	a
e	t	m	r	p	u	u	r	p	n	a	v	x	s	e	l	q	m	b	i
f	e	q	a	d	o	y	a	n	l	s	x	e	j	c	t	g	a	u	a
n	t	f	g	r	y	f	s	w	c	p	h	r	b	g	i	x	r	t	l
y	b	i	o	a	t	t	s	a	b	y	h	s	j	s	a	c	g	t	e
r	l	r	n	r	l	i	h	w	e	s	d	c	n	p	o	c	k	e	o
b	a	e	f	l	y	m	o	s	q	u	i	t	o	i	f	q	x	r	b
d	d	f	l	p	p	n	p	i	u	i	m	f	g	d	r	s	l	f	r
z	y	l	y	r	d	a	p	w	w	r	d	q	t	e	i	s	y	l	x
v	b	y	v	c	a	t	e	r	p	i	l	l	a	r	m	m	u	y	n
b	u	m	o	c	b	f	r	n	e	r	t	b	t	f	f	u	i	g	m
t	g	c	g	d	q	w	a	f	c	s	n	k	m	c	n	o	g	a	k
c	z	s	t	c	c	p	z	c	a	m	d	l	r	v	s	r	l	k	o
k	y	n	t	s	o	a	r	j	z	a	m	w	b	f	k	x	v	g	f

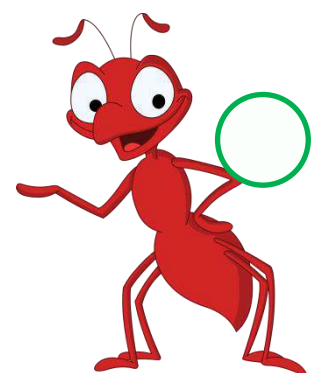
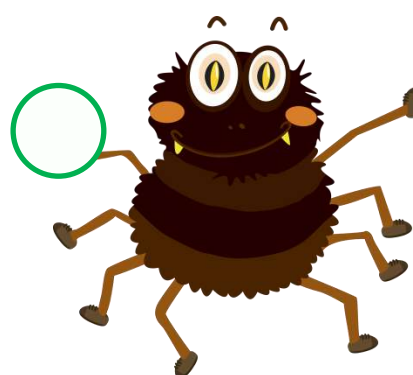
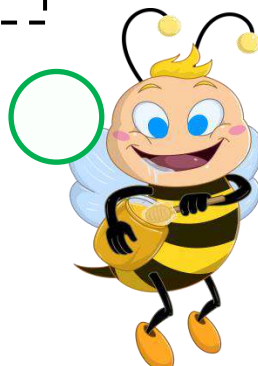
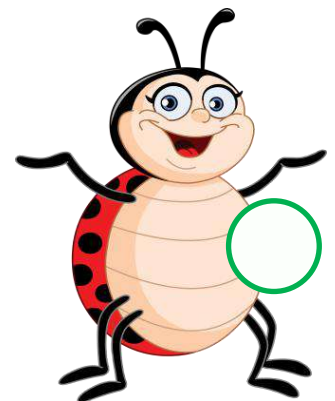
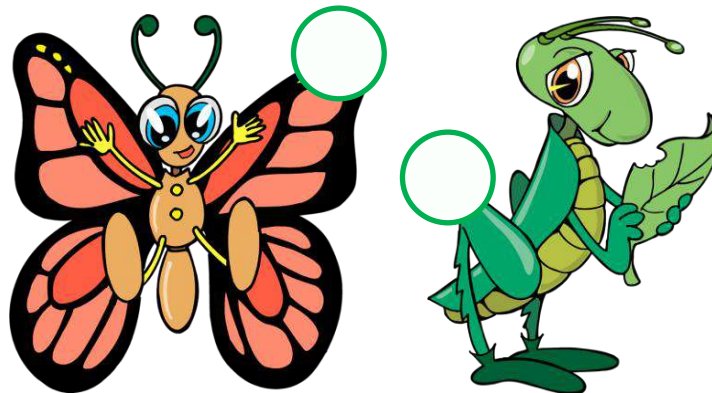
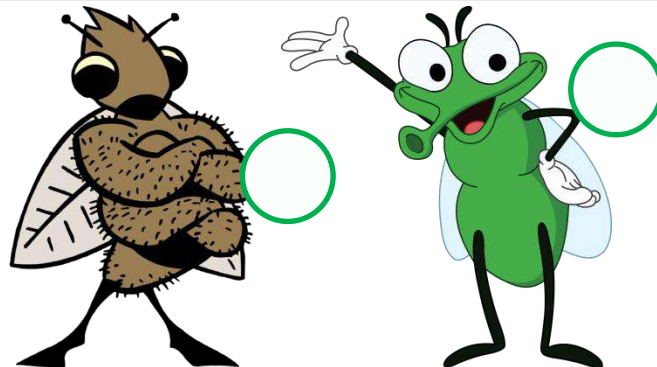
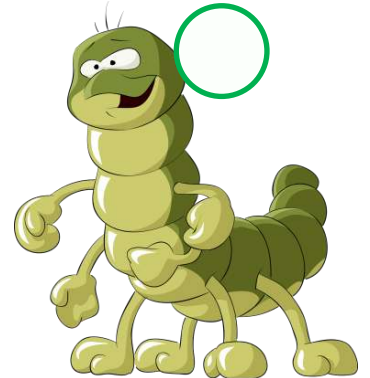
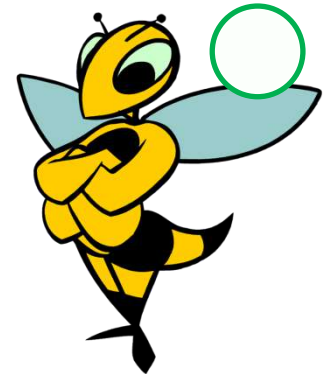

1. butterfly
2. bee
3. ant
4. ladybug
5. mosquito
6. spider
7. caterpillar
8. wasp
9. grasshopper
10. fly
11. dragonfly
12. firefly

INSECTS VOCABULARY WORD SEARCH PUZZLE ANSWER KEY

Find and circle the words in the word search puzzle and number the pictures

b	t	b	a	n	t	x	u	q	w	j	x	c	u	b	o	f	x	f	k
u	m	z	d	s	k	j	g	r	s	w	y	u	p	e	r	q	r	m	a
e	t	m	r	p	u	u	r	p	n	a	v	x	s	e	l	q	m	b	i
f	e	q	a	d	o	y	a	n	l	s	x	e	j	c	t	g	a	u	a
n	t	f	g	r	y	f	s	w	c	p	h	r	b	g	i	x	r	t	l
y	b	i	o	a	t	t	s	a	b	y	h	s	j	s	a	c	g	t	e
r	l	r	n	r	l	i	h	w	e	s	d	c	n	p	o	c	k	e	o
b	a	e	f	l	y	m	o	s	q	u	i	t	o	i	f	q	x	r	b
d	d	f	l	p	p	n	p	i	u	i	m	f	g	d	r	s	l	f	r
z	y	l	y	r	d	a	p	w	w	r	d	q	t	e	i	s	y	l	x
v	b	y	v	c	a	t	e	r	p	i	l	l	a	r	m	m	u	y	n
b	u	m	o	c	b	f	r	n	e	r	t	b	t	f	f	u	i	g	m
t	g	c	g	d	q	w	a	f	c	s	n	k	m	c	n	o	g	a	k
c	z	s	t	c	c	p	z	c	a	m	d	l	r	v	s	r	l	k	o
k	y	n	t	s	o	a	r	j	z	a	m	w	b	f	k	x	v	g	f

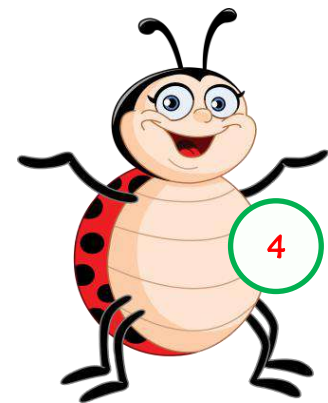
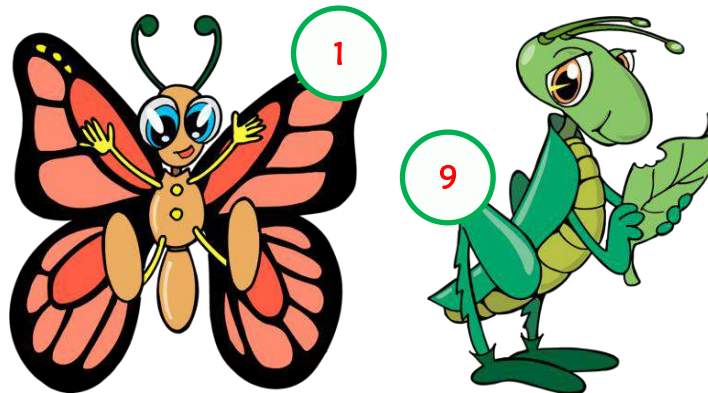
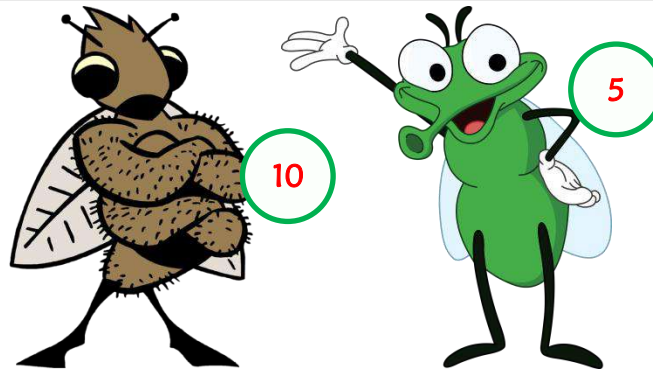
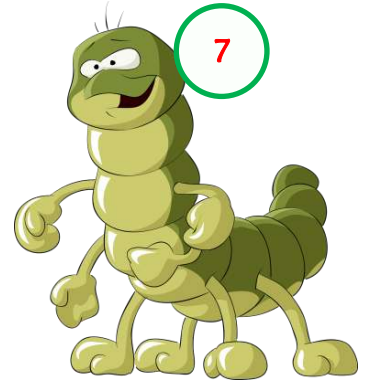
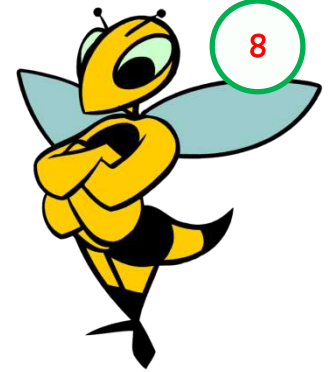
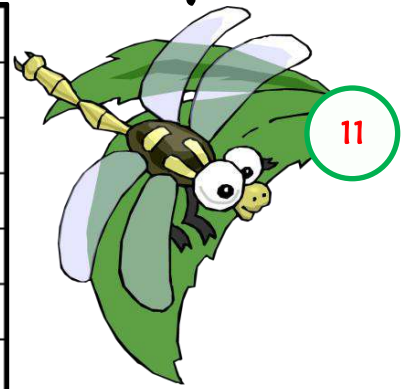

1. butterfly
2. bee
3. ant
4. ladybug
5. mosquito
6. spider
7. caterpillar
8. wasp
9. grasshopper
10. fly
11. dragonfly
12. firefly

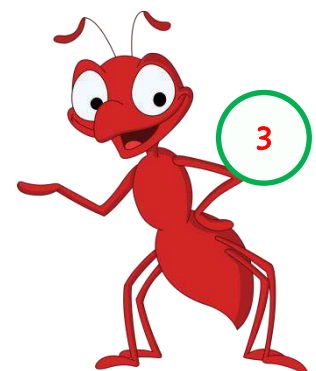
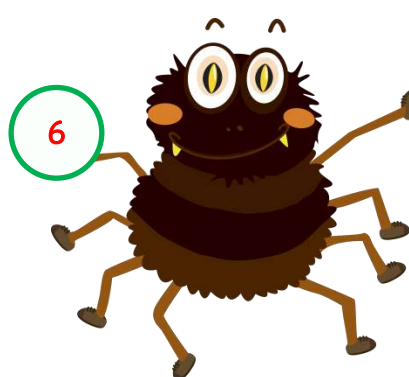
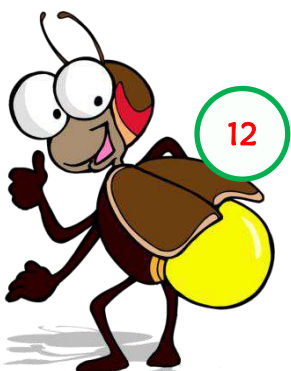

INSECTS CROSSWORD PUZZLE

Look at the numbers on the pictures and write the insects vocabulary in the crossword puzzle

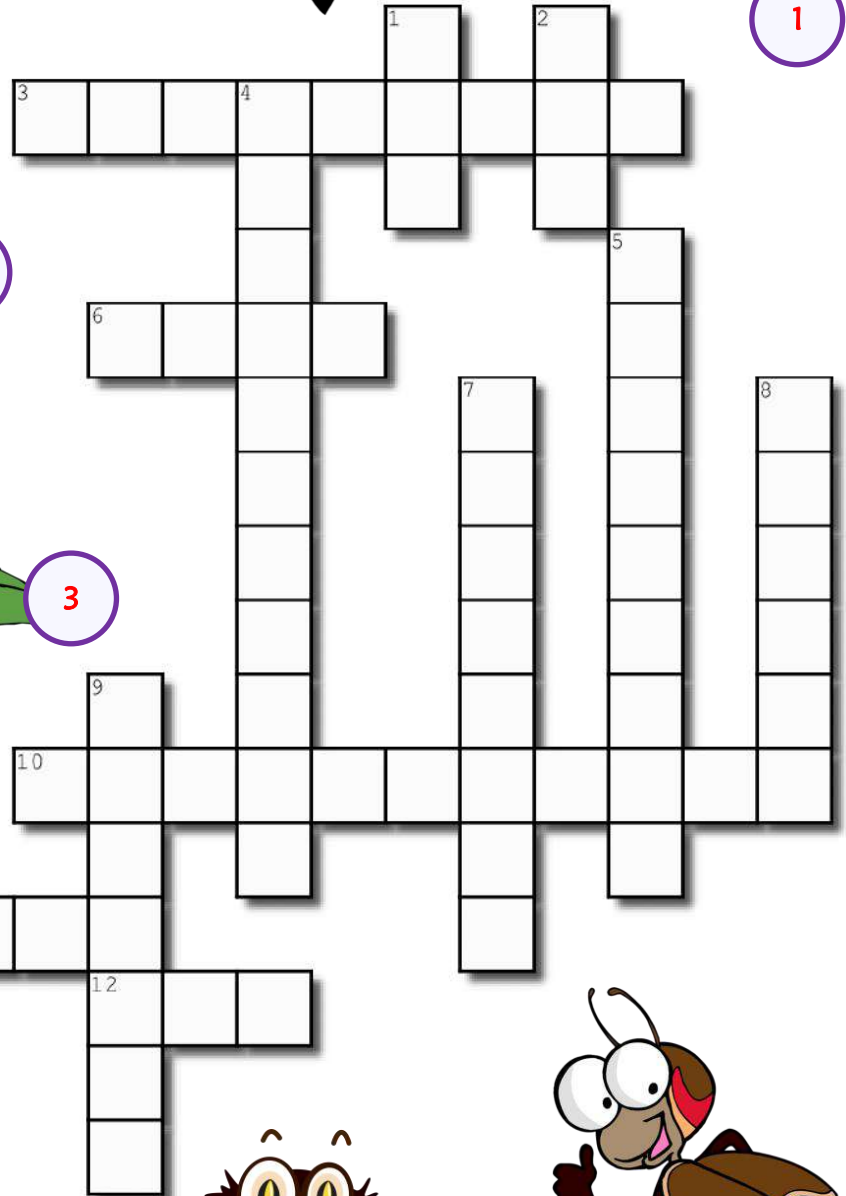
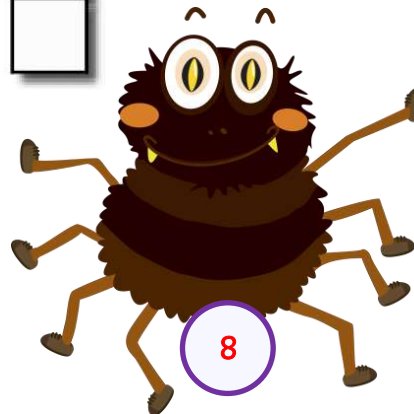
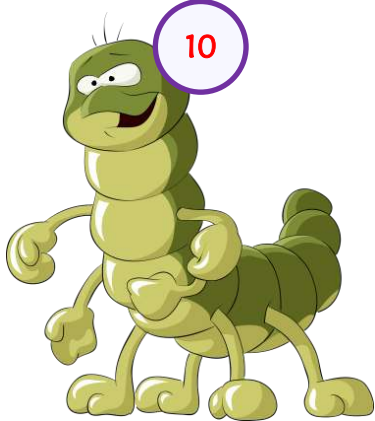
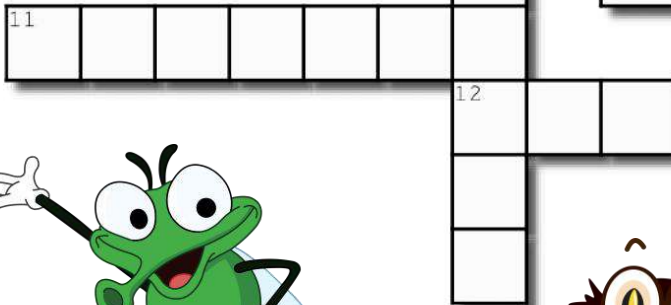
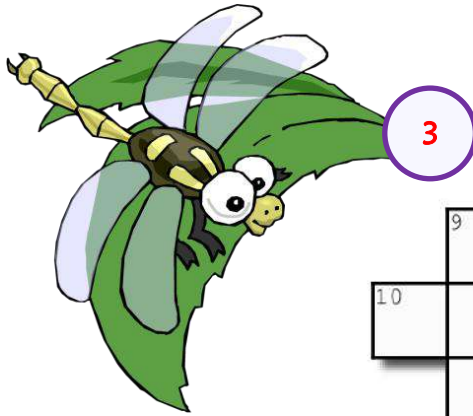
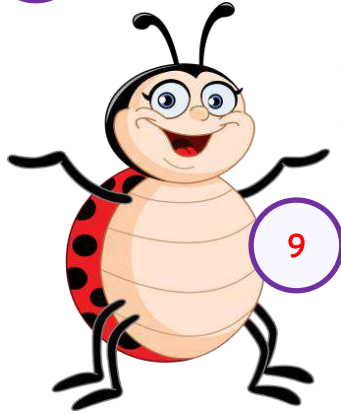
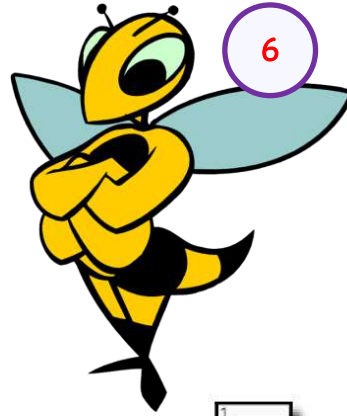
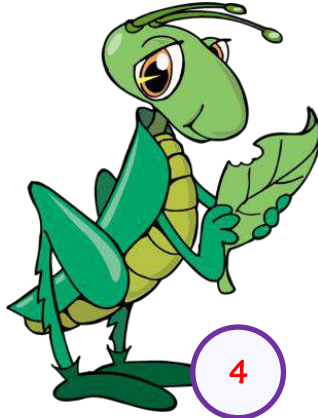
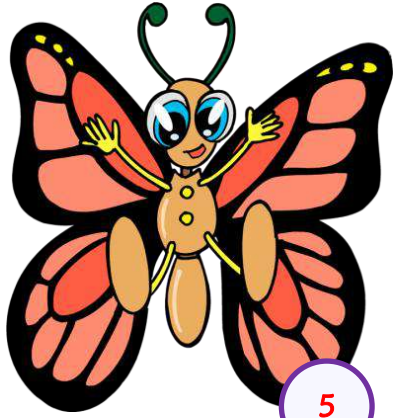

ANSWER KEY

Across

3. dragonfly

6. wasp

10. caterpillar

11. firefly

12. bee

Down

1. ant

2. fly

4. grasshopper

5. butterfly

7. mosquito

8. spider

9. ladybug

INSECTS MISSING LETTERS IN WORDS

Write the missing letters in the boxes to complete the insects vocabulary

b_tt_rfly

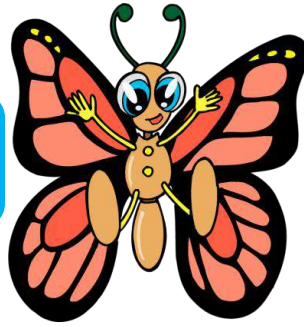

_nt

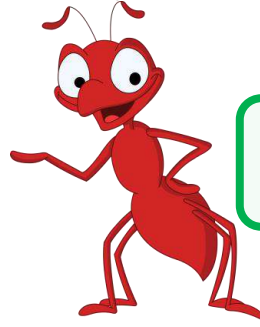

b__

sp_d_r



m_sq__t_

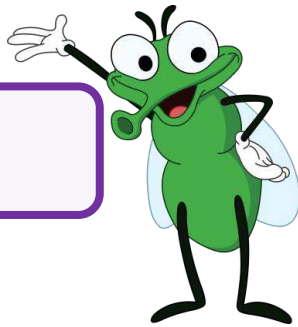

l_dyb_g

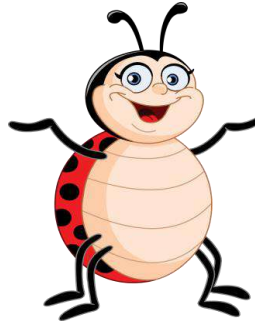

c_t_rp_ll_r

fl_

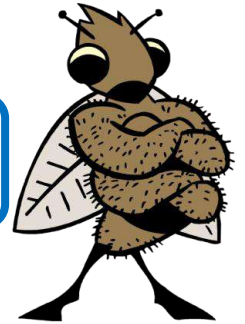

w_sp



gr_ssh_pp_r



dr_g_nfly

f_r_fly



INSECTS MISSING LETTERS IN WORDS ANSWER KEY

Write the missing letters in the boxes to complete the insects vocabulary

butterefly

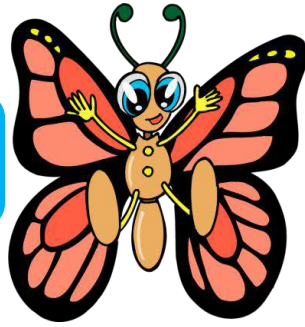

ant



bee

spider



mosquito

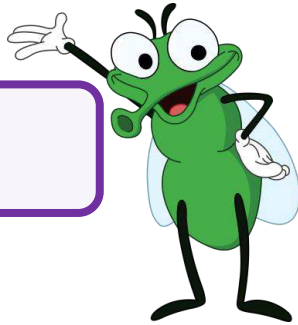

ladybug

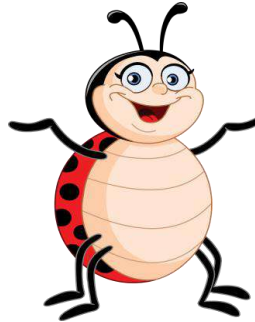

caterpillar

fly

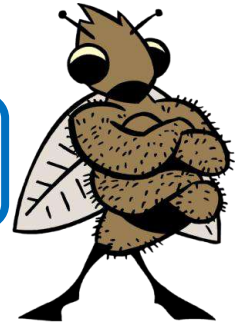

wasp



grasshopper



dragonfly

firefly



INSECTS UNSCRAMBLE THE WORDS

Unscramble the insects vocabulary and number the pictures

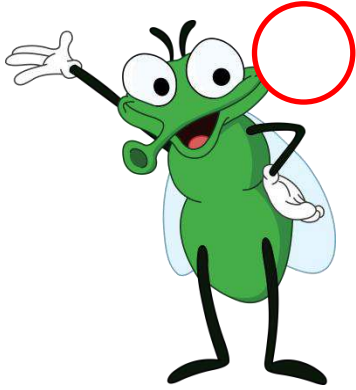
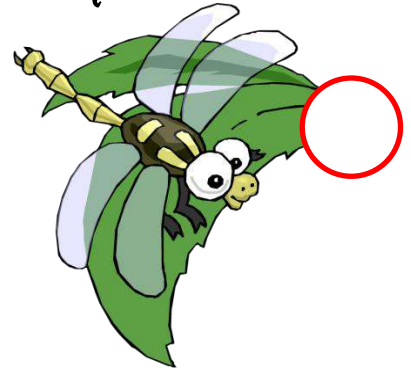
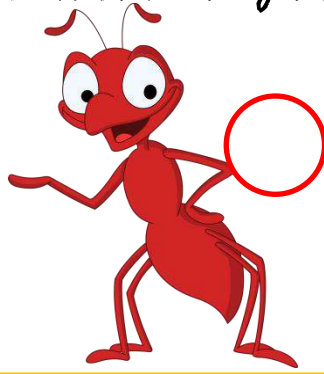
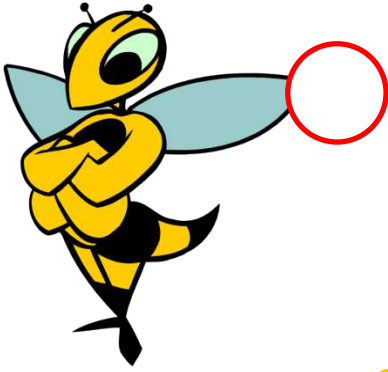

1. fueyrlbtt _____

2. ebe _____

3. tan _____

4. dbuglya _____

5. oqmiosut _____

6. dspier _____

7. iarletacplr _____

8. spwa _____

9. pasrerogshp _____

10. lyf _____

11. alfdnoryg _____

12. iferlyf _____

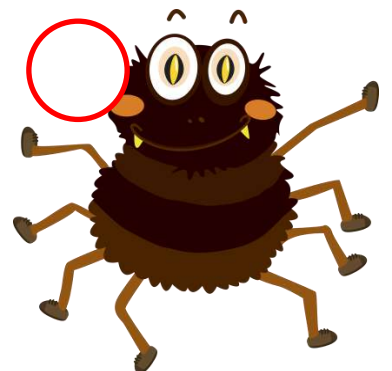
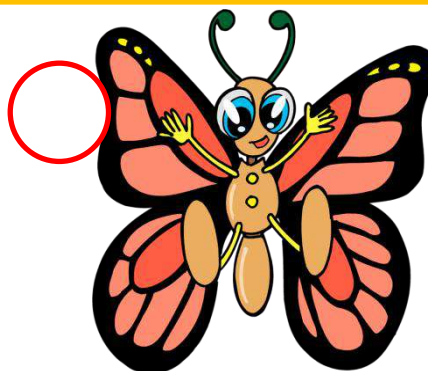
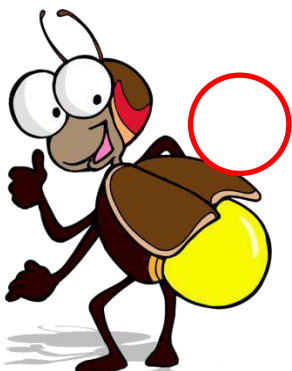
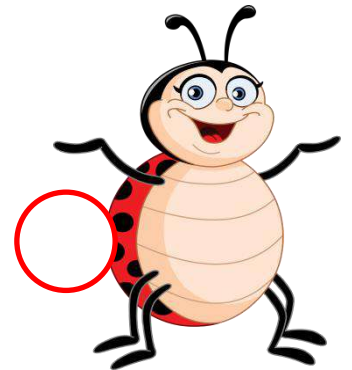
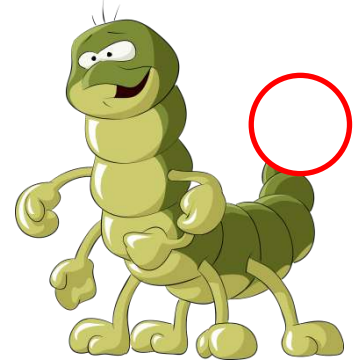
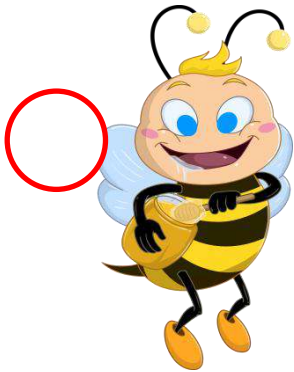
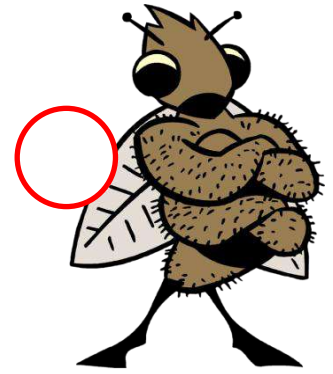

INSECTS UNSCRAMBLE THE WORDS ANSWER KEY

Unscramble the insects vocabulary and number the pictures

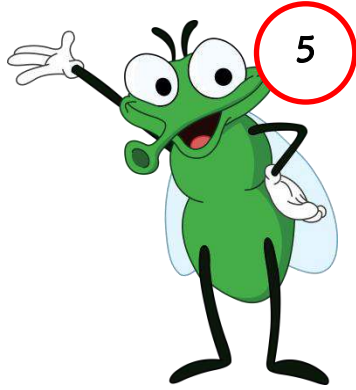
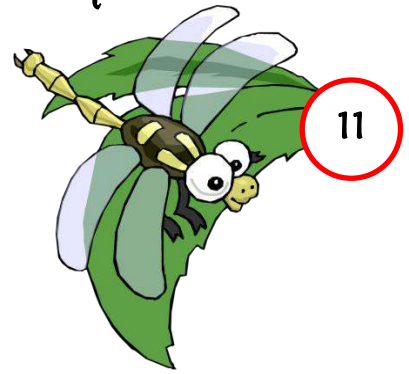
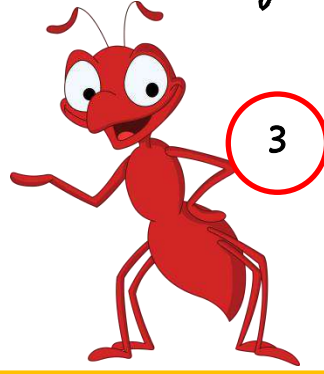
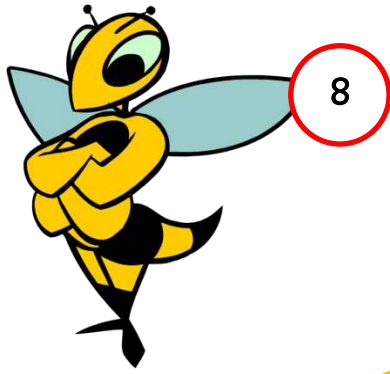

1. fueyrlbtt butterfly

2. ebe bee

3. tan ant

4. dbuglya ladybug

5. oqmiosut mosquito

6. dspier spider

7. iarletacplr caterpillar

8. spwa wasp

9. pasrerogshp grasshopper

10. lyf fly

11. alfdnoryg dragonfly

12. iferlyf firefly

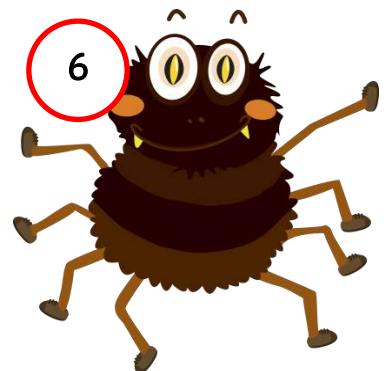
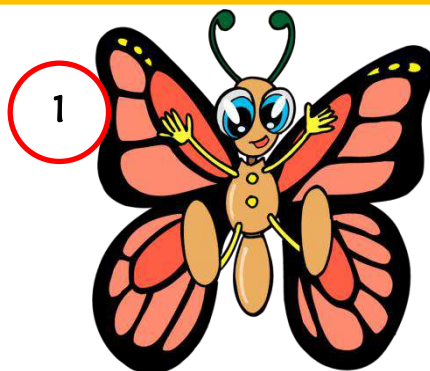
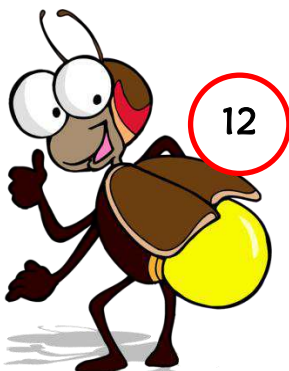
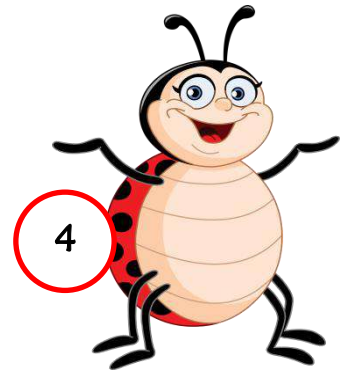
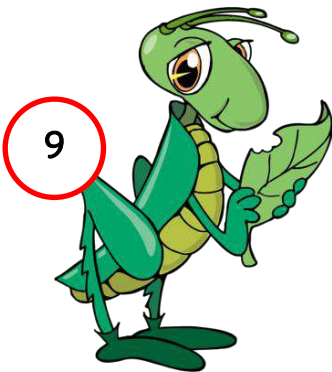
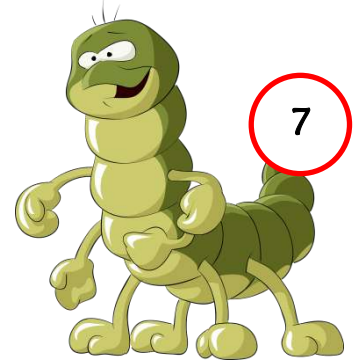
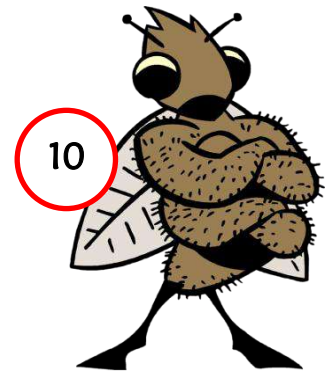

INSECTS MULTIPLE CHOICE TEST

Look at the pictures, choose and circle the correct option.

1

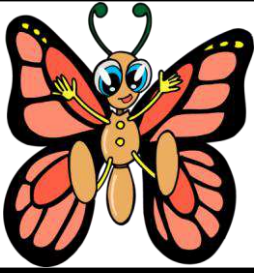

- a) wasp
- b) mosquito
- c) butterfly
- d) firefly

2



- a) spider
- b) caterpillar
- c) dragonfly
- d) bee

3

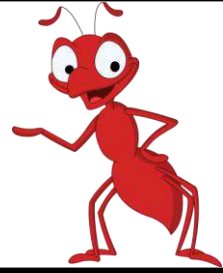

- a) ant
- b) grasshopper
- c) fly
- d) ladybug

4



- a) grasshopper
- b) ant
- c) ladybug
- d) dragonfly

5



- a) butterfly
- b) fly
- c) caterpillar
- d) mosquito

6



- a) firefly
- b) spider
- c) bee
- d) wasp

7



- a) caterpillar
- b) bee
- c) fly
- d) spider

8



- a) ladybug
- b) firefly
- c) wasp
- d) butterfly

9



- a) mosquito
- b) ant
- c) dragonfly
- d) grasshopper

10

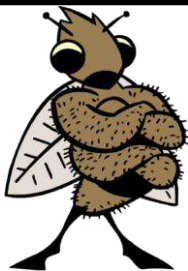

- a) ant
- b) fly
- c) grasshopper
- d) ladybug

11



- a) dragonfly
- b) spider
- c) caterpillar
- d) butterfly

12



- a) wasp
- b) mosquito
- c) firefly
- d) bee

INSECTS MULTIPLE CHOICE TESTS ANSWER KEY

TEST 1

1) c

2) d

3) a

4) c

5) d

6) b

7) a

8) c

9) d

10) b

11) a

12) c

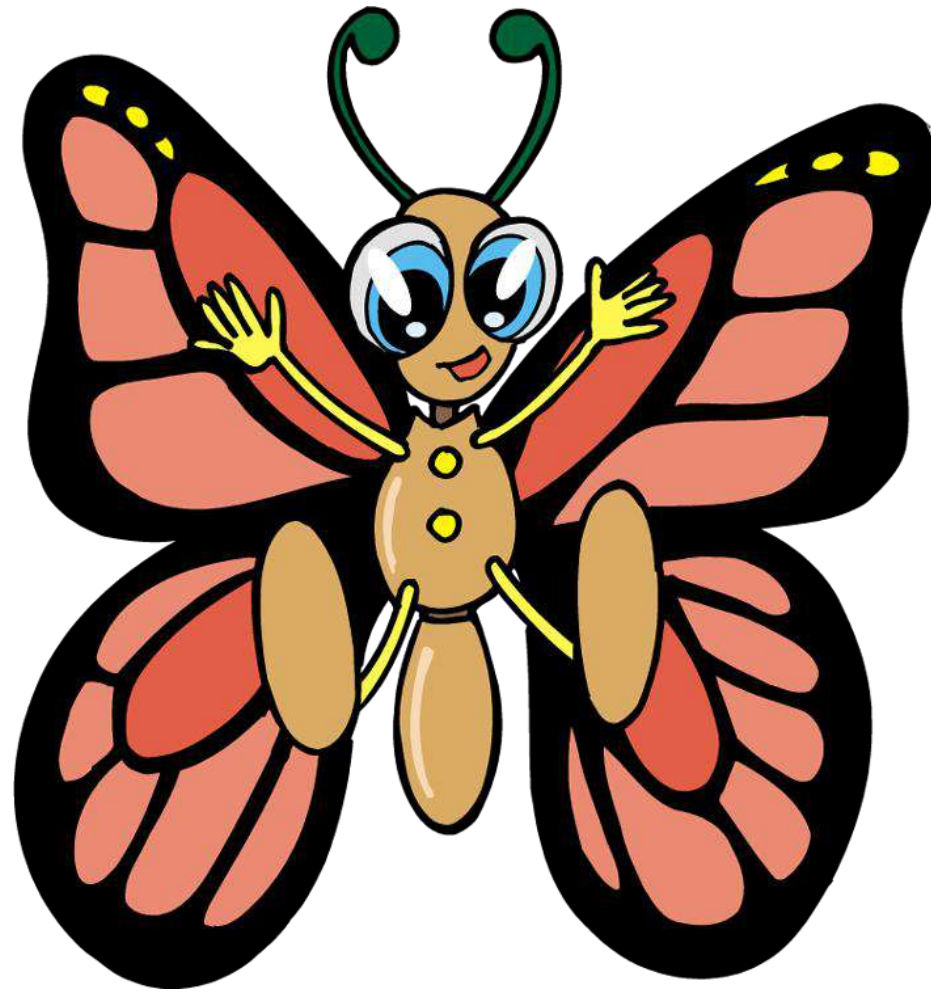

butterfly



bee

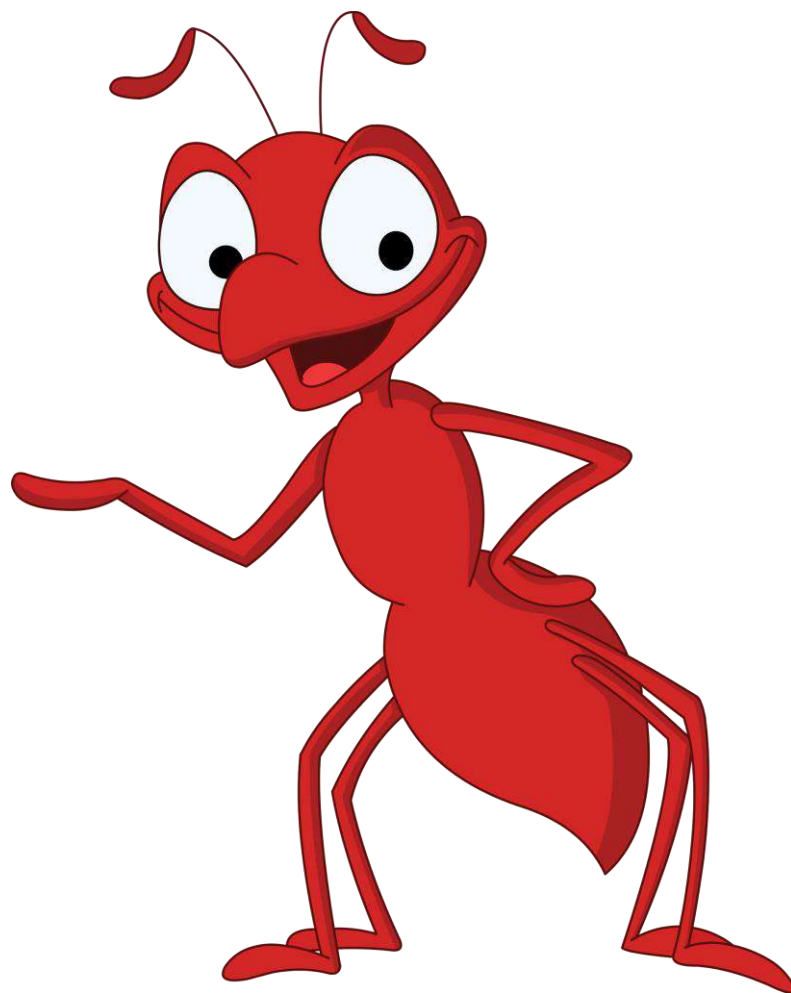

ant



ladybug



mosquito



spider

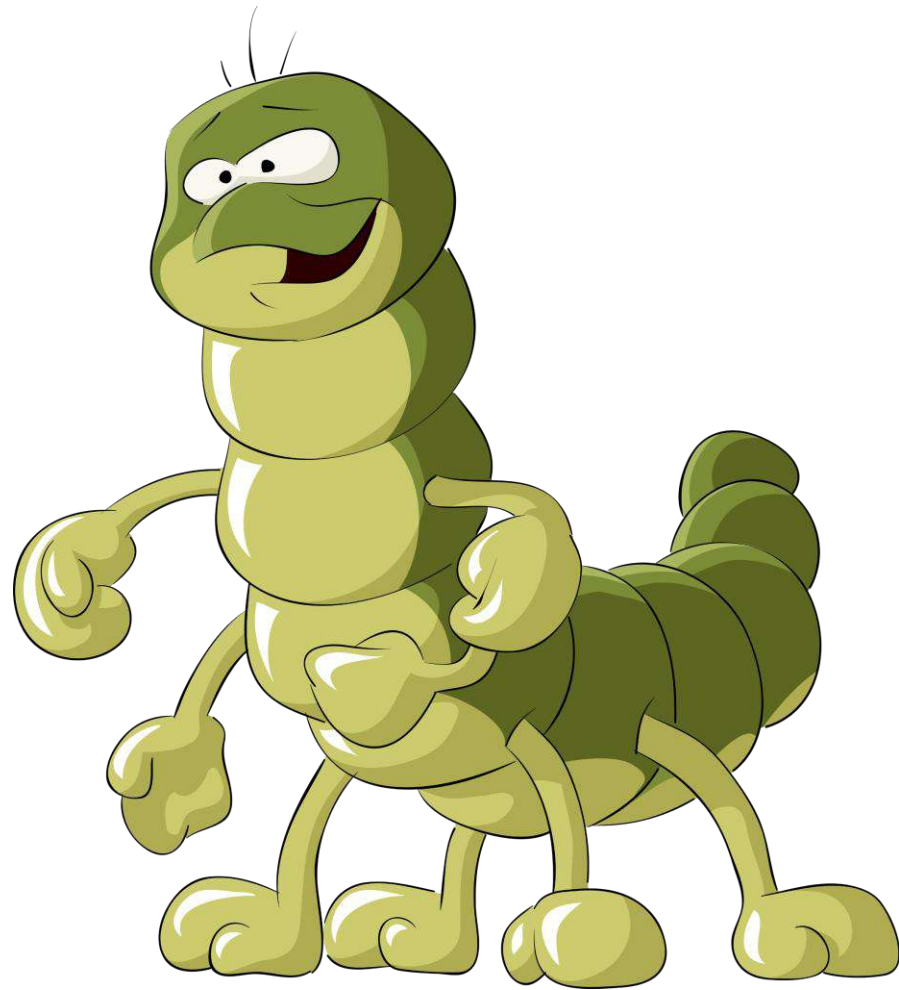

caterpillar



wasp



grasshopper

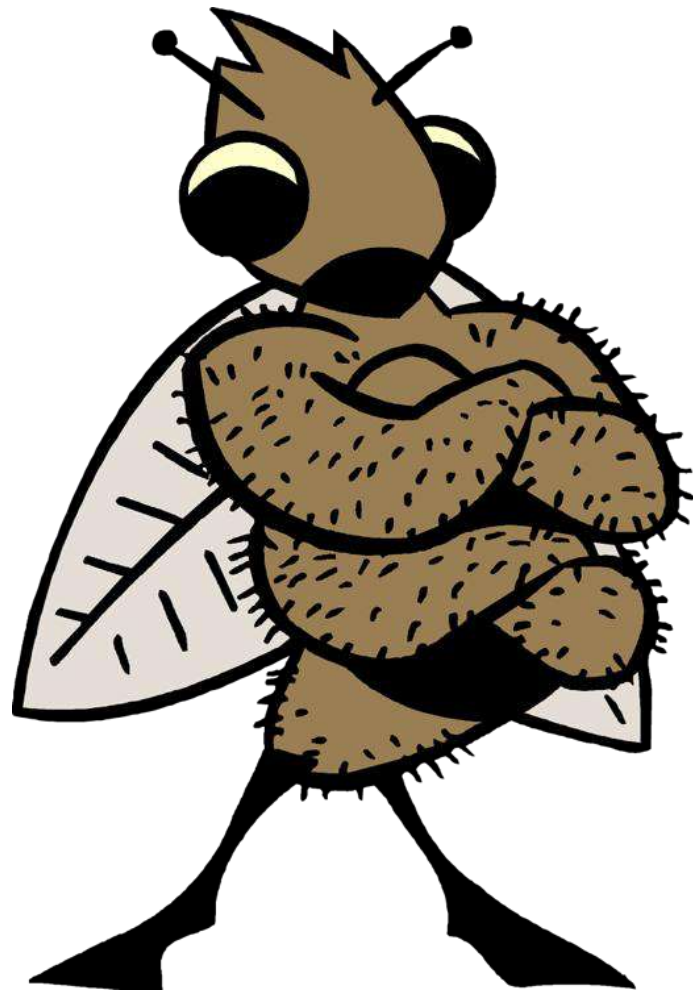

fly

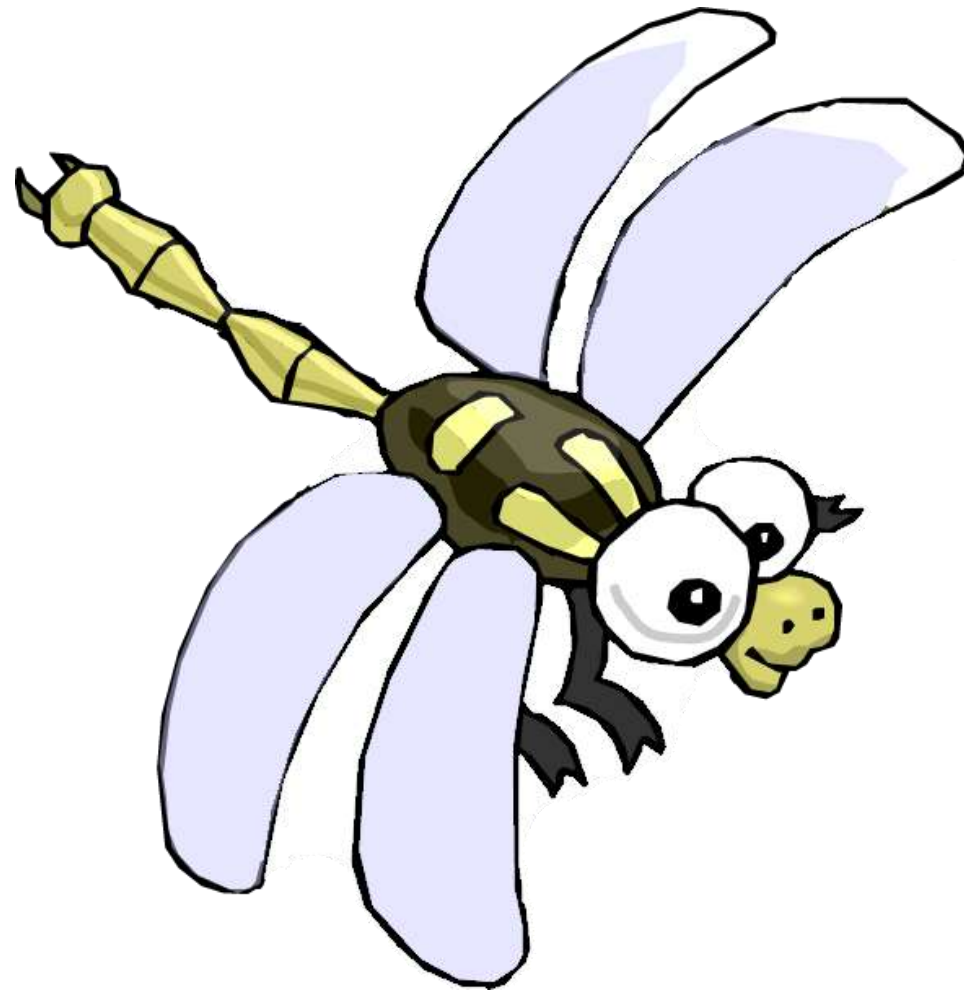

dragonfly



firefly

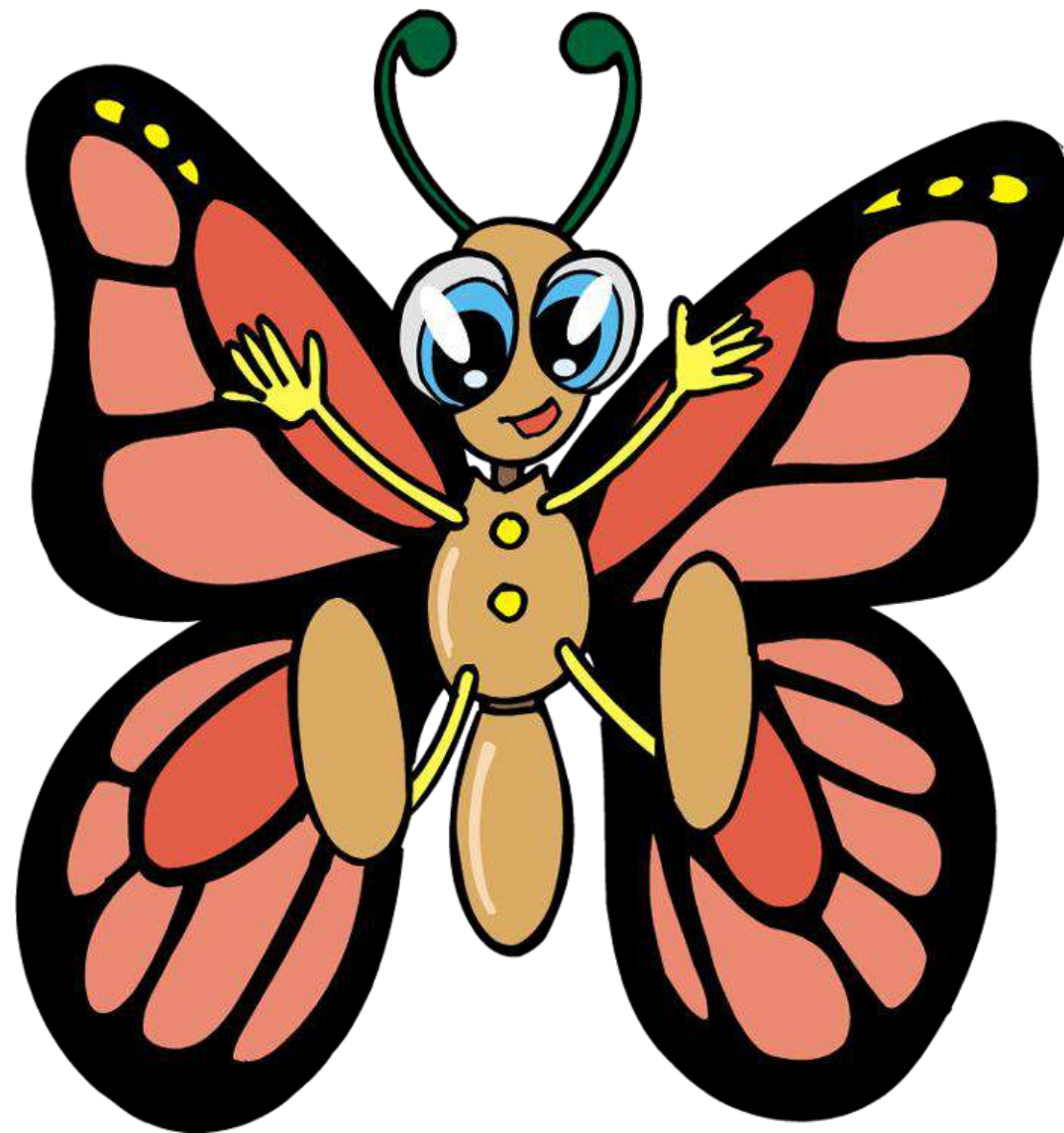



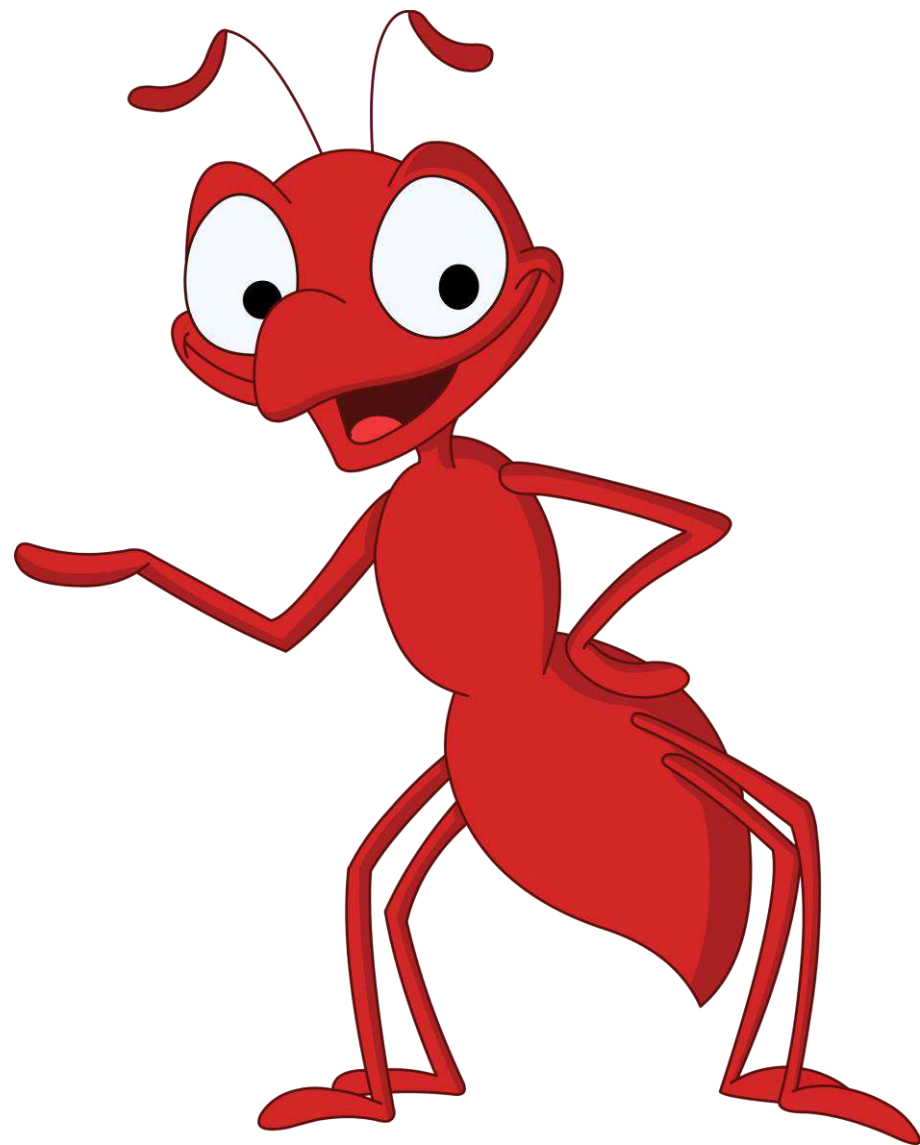

Copyright © 08/10/2019 englishworksheets.com. All rights reserved.







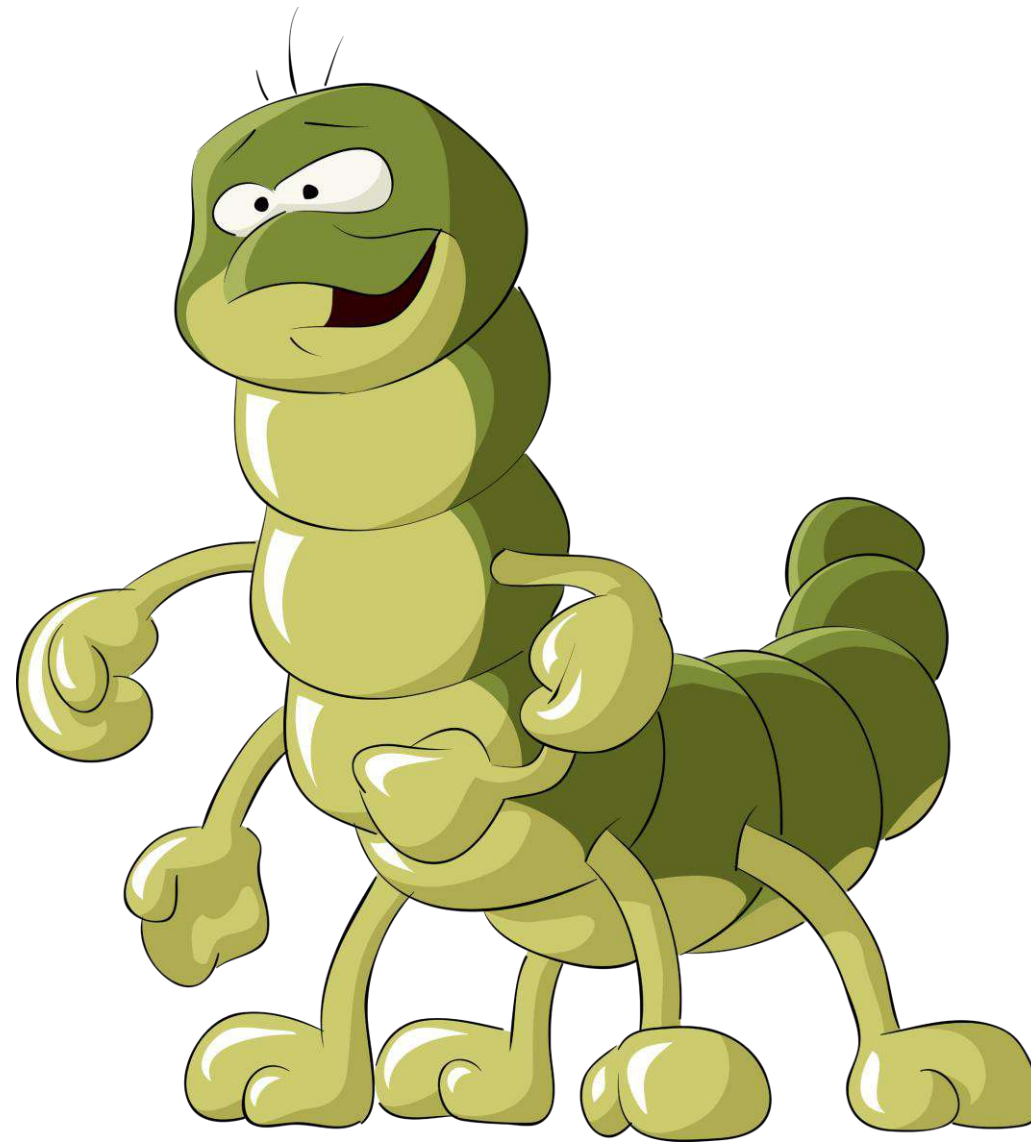





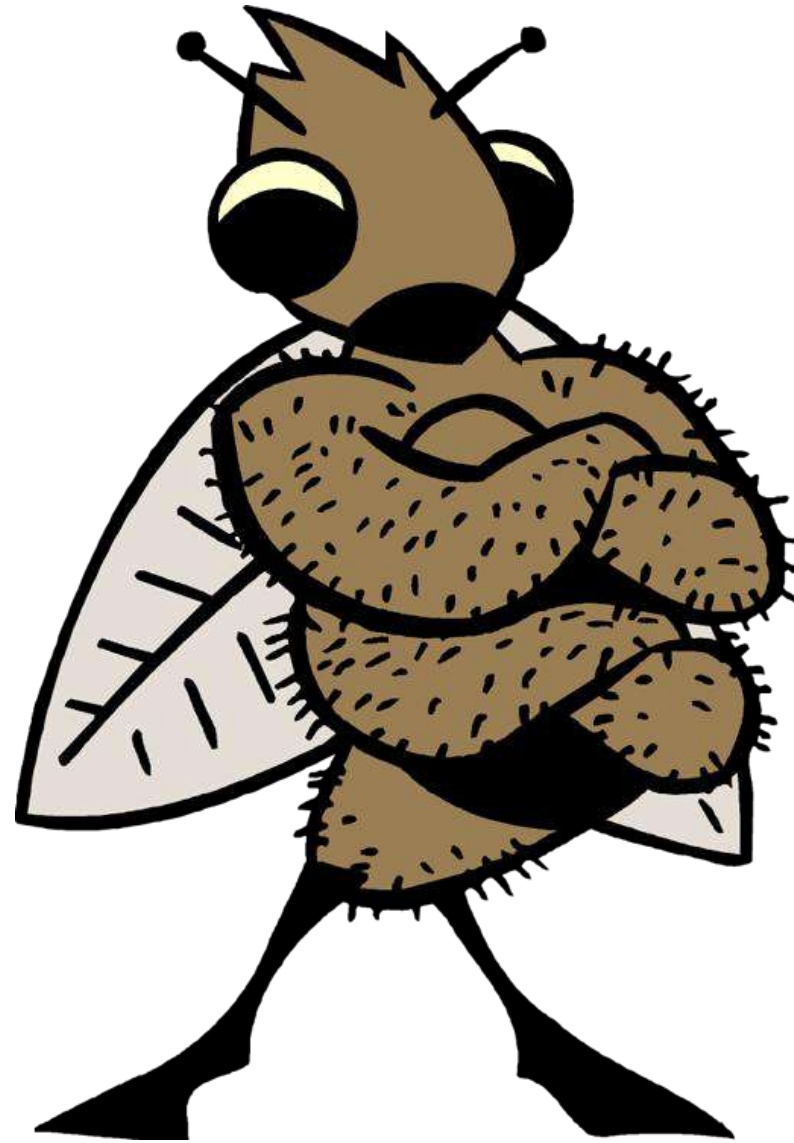

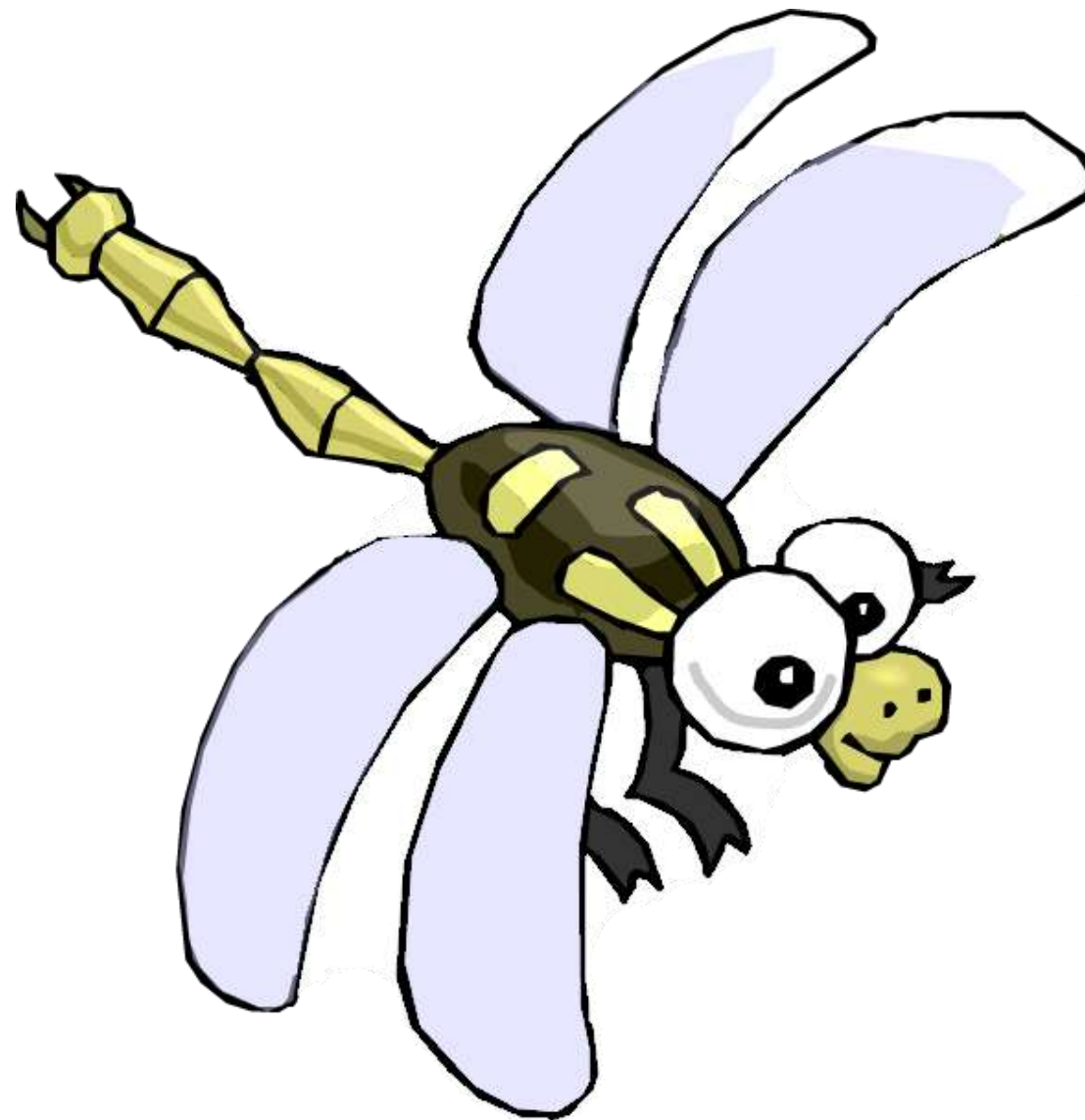

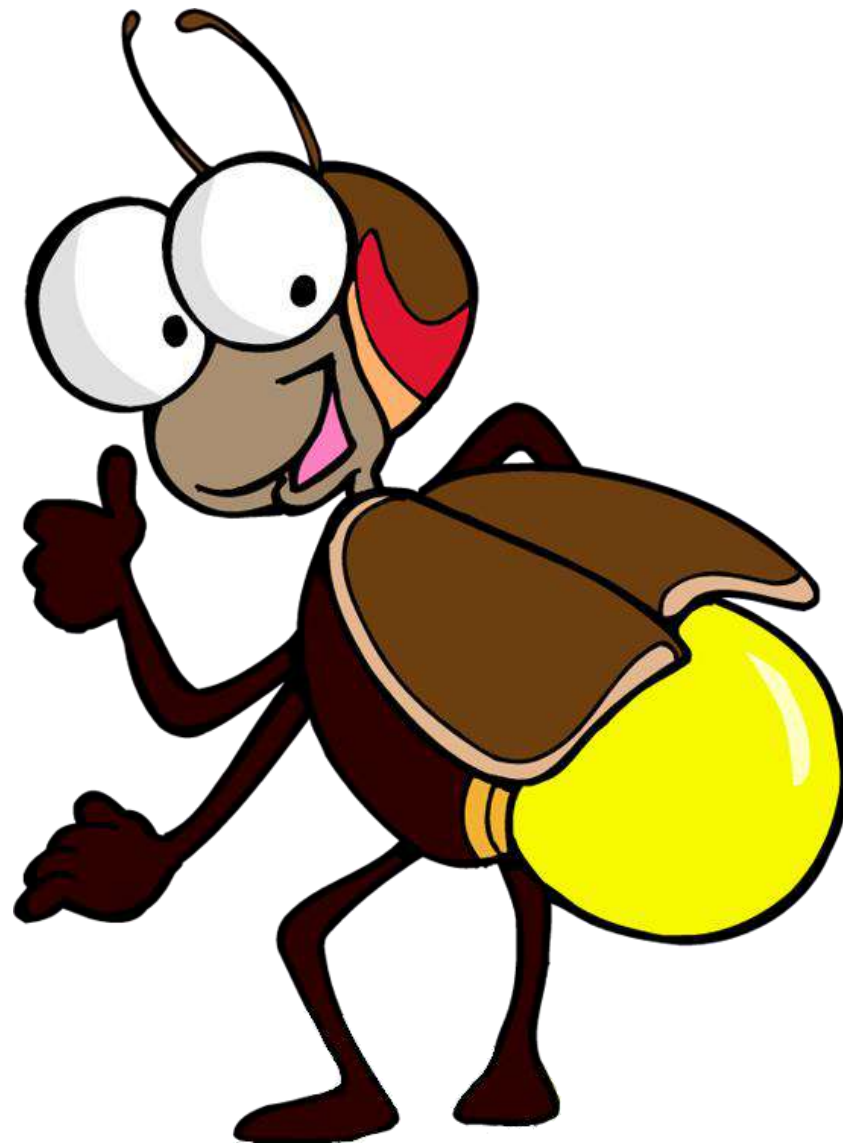

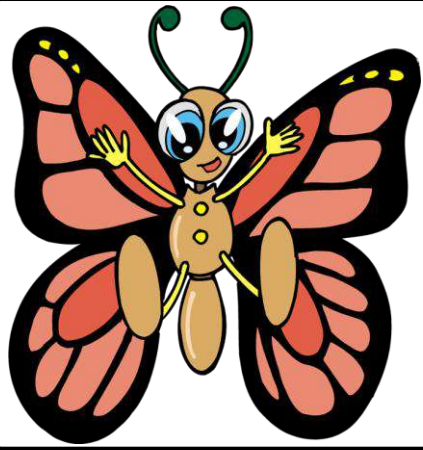

butterfly

Copyright © 08/10/2019 englishsheets.com. All rights reserved.



bee

Copyright © 08/10/2019 englishsheets.com. All rights reserved.

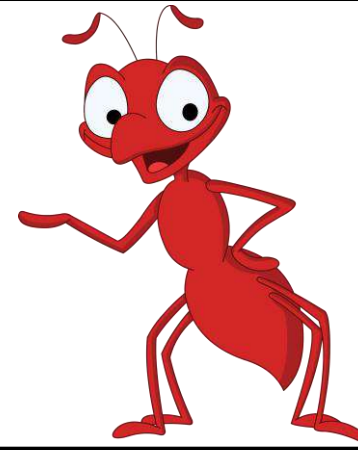

ant

Copyright © 08/10/2019 englishsheets.com. All rights reserved.

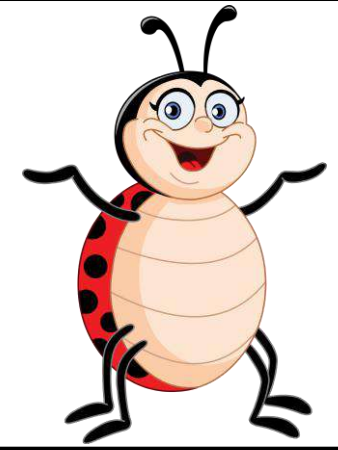

ladybug

Copyright © 08/10/2019 englishsheets.com. All rights reserved.



mosquito

Copyright © 08/10/2019 englishsheets.com. All rights reserved.

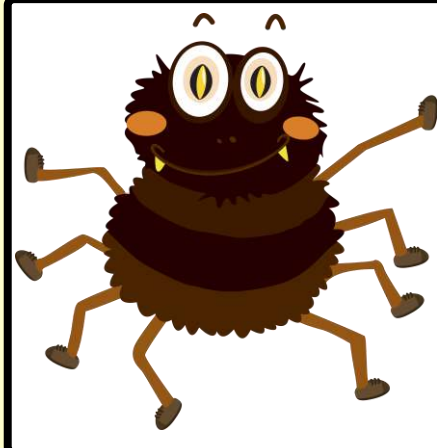

spider

Copyright © 08/10/2019 englishsheets.com. All rights reserved.

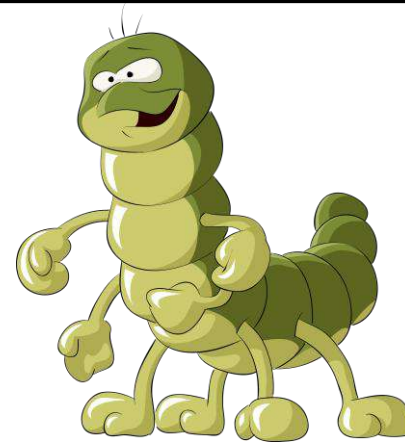

caterpillar

Copyright © 08/10/2019 englishsheets.com. All rights reserved.

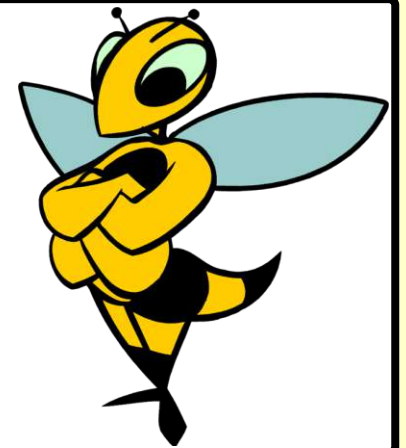

wasp

Copyright © 08/10/2019 englishsheets.com. All rights reserved.



grasshopper

Copyright © 08/10/2019 englishsheets.com. All rights reserved.

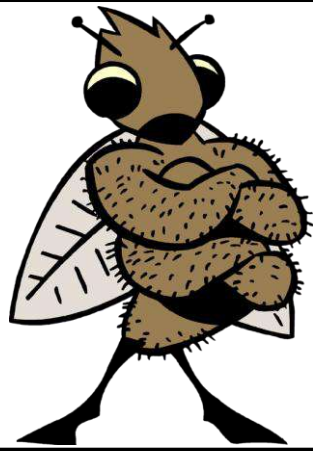

fly

Copyright © 08/10/2019 englishsheets.com. All rights reserved.

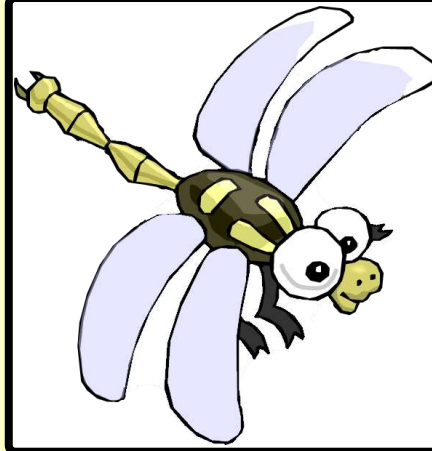

dragonfly

Copyright © 08/10/2019 englishsheets.com. All rights reserved.

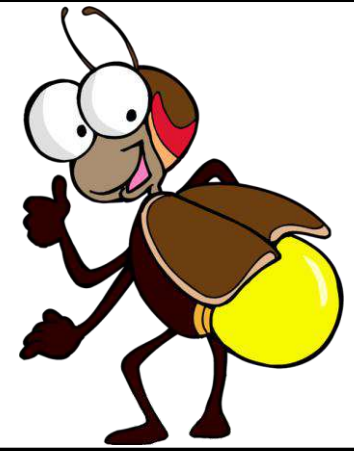

firefly

Copyright © 08/10/2019 englishsheets.com. All rights reserved.

INSECTS FIDGET SPINNER GAME

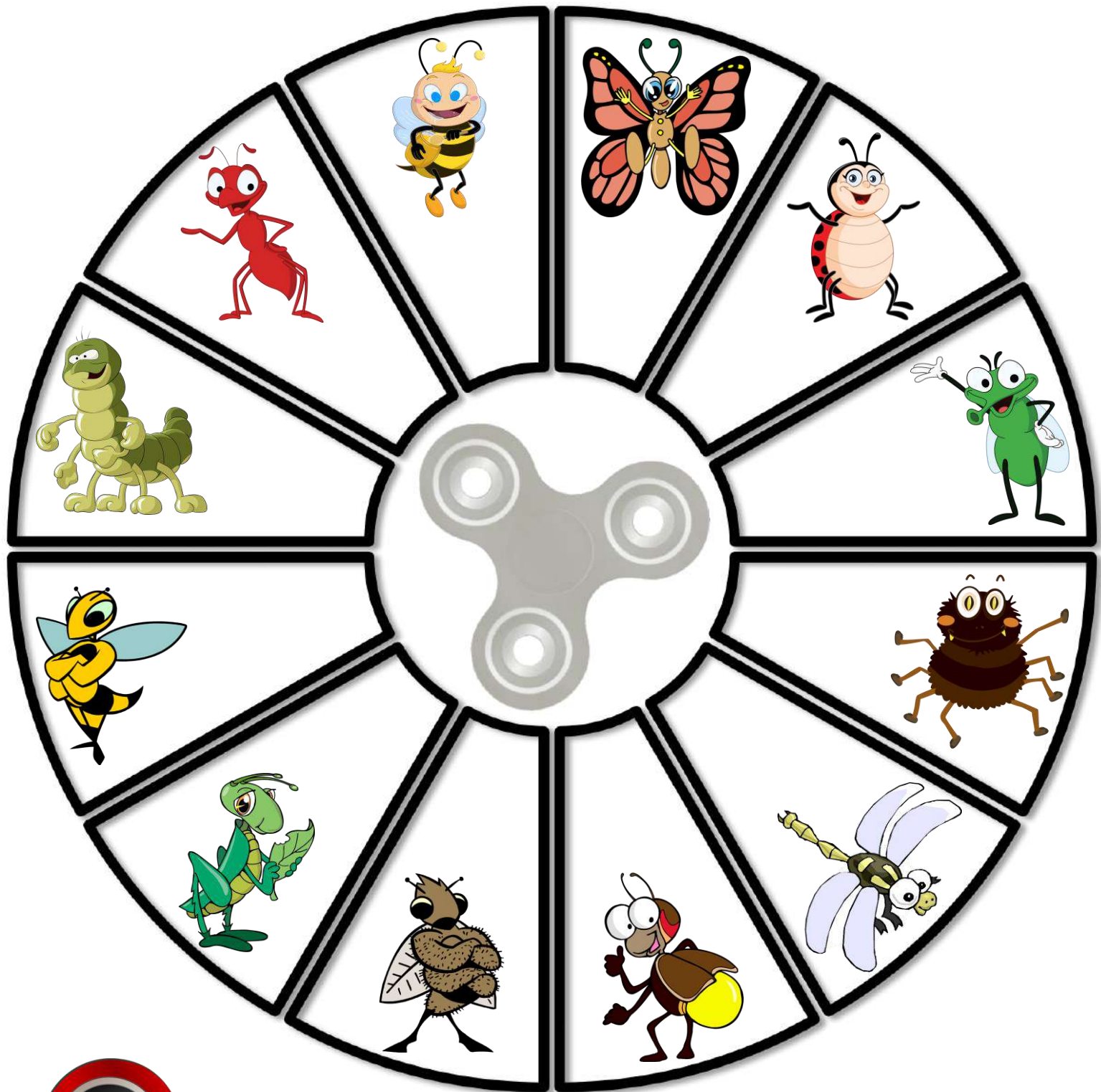

- Cut a small arrow from paper or craft foam and stick it onto the fidget spinner as your pointer.
- Place the fidget spinner in the middle of the vocabulary circle.
- Spin it and say the word quickly!



butterfly



bee



ant



ladybug



mosquito

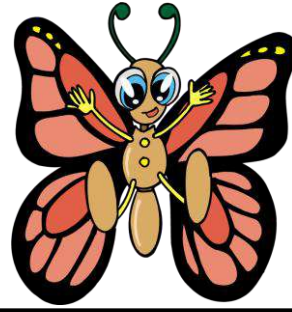

spider

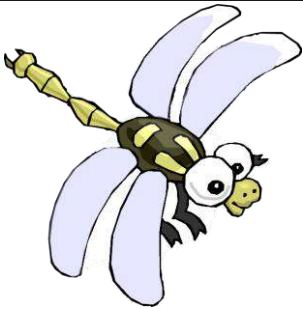

caterpillar



wasp



grasshopper

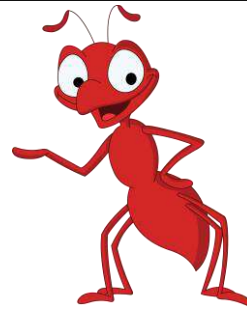

fly



dragonfly



firefly

HOUSES/HOMES PICTURE DICTIONARY



cottage



stilt house

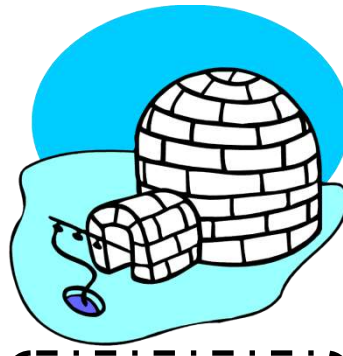

igloo



farmhouse



hut

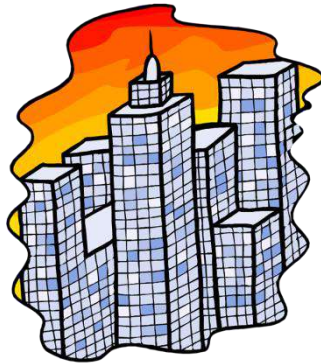

skyscraper

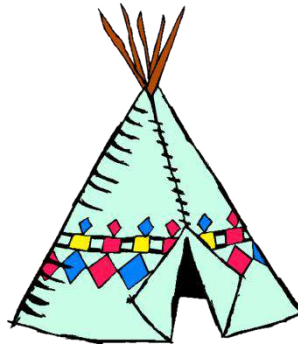

teepee



castle

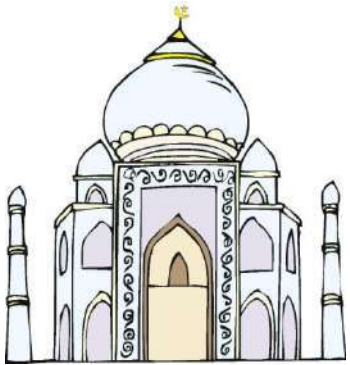

palace



mansion



tent



cave



tree house



caravan



lighthouse



apartment building

HOUSES/HOMES PICTURE DICTIONARY



cottage



stilt house

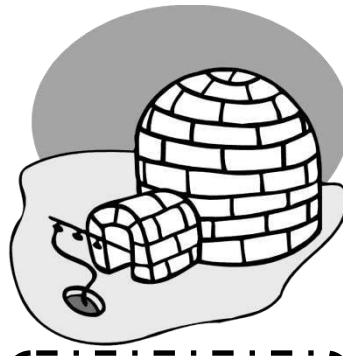

igloo



farmhouse



hut



skyscraper

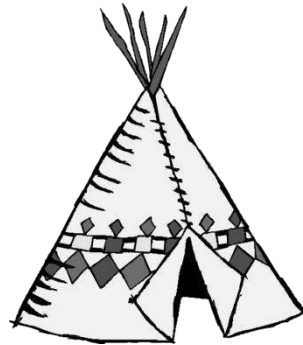

teepee



castle

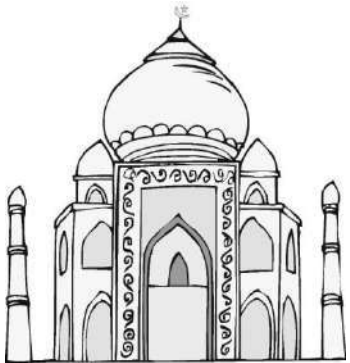

palace



mansion



tent



cave



tree house



caravan

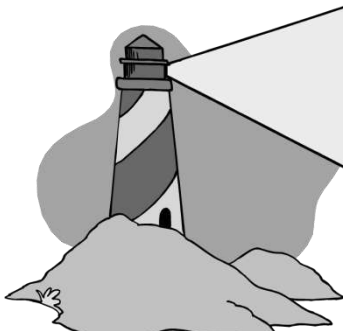

lighthouse



apartment building

HOUSES/HOMES VOCABULARY MATCHING WORKSHEET

Choose the correct words from the list below and write them under the correct pictures



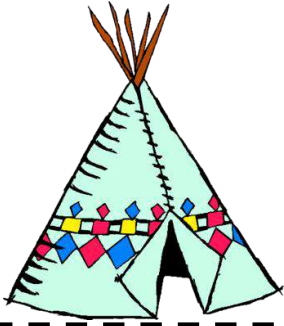

WORD LIST

- cottage
- stilt house
- igloo
- farmhouse
- hut
- skyscraper
- teepee
- castle
- palace
- mansion
- tent
- cave
- tree house
- caravan
- lighthouse
- apartment building





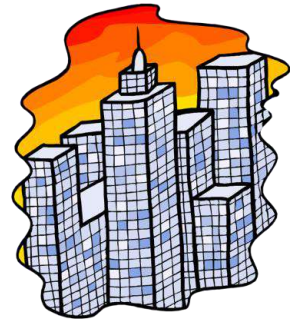
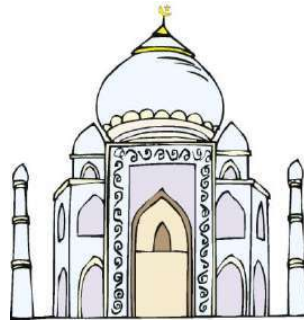
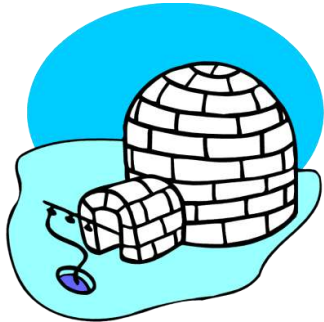

HOUSES/HOMES VOCABULARY MATCHING WORKSHEET ANSWER KEY

Choose the correct words from the list below and write them under the correct pictures



mansion



castle

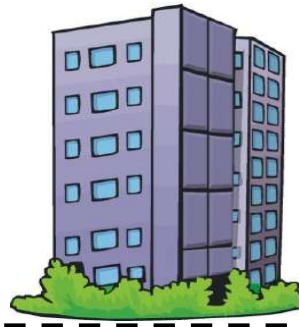

apartment building



stilt house

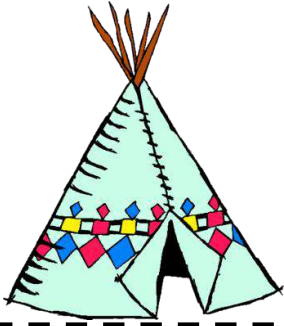

teepee



tree house

WORD LIST

- cottage
- stilt house
- igloo
- farmhouse
- hut
- skyscraper
- teepee
- castle
- palace
- mansion
- tent
- cave
- tree house
- caravan
- lighthouse
- apartment building



farmhouse



cave



hut



caravan



cottage



tent



lighthouse

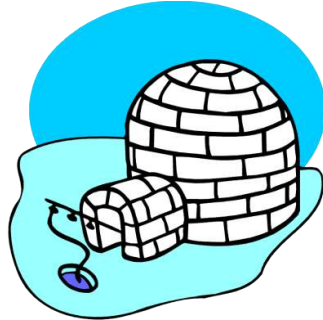

igloo



palace

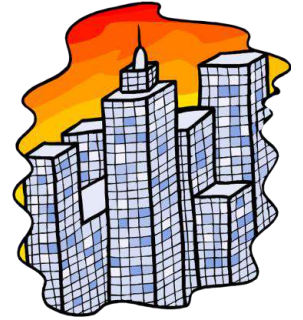

skyscraper

HOUSES/HOMES VOCABULARY WORD SEARCH PUZZLE

Find and circle the words in the word search puzzle and number the pictures

g	h	g	m	h	t	t	g	q	d	p	a	e	q	d	i	u
h	y	s	p	z	h	e	p	p	x	n	p	a	o	i	i	u
u	o	q	w	v	a	n	y	x	n	s	a	k	m	b	k	r
t	g	n	s	z	u	t	l	y	v	q	r	f	a	k	o	w
l	a	k	x	r	t	w	s	v	b	h	t	z	n	u	c	f
i	n	t	e	e	p	e	e	h	t	f	m	k	s	p	x	s
g	t	k	r	b	y	a	l	m	r	a	e	s	i	a	z	t
h	s	k	y	s	c	r	a	p	e	r	n	c	o	l	k	i
t	p	w	r	c	o	h	e	a	e	m	t	a	n	a	k	l
h	v	c	a	s	t	l	e	g	h	h	b	r	y	c	s	t
o	c	a	v	e	t	x	e	r	o	o	u	a	f	e	s	h
u	j	m	e	f	a	t	s	y	u	u	i	v	i	v	k	o
s	d	s	d	i	g	l	o	o	s	s	l	a	m	x	u	u
e	w	p	m	j	e	u	i	u	e	e	d	n	z	i	w	s
g	e	q	o	a	z	j	w	l	w	o	i	w	z	o	h	e
i	f	e	q	c	a	o	r	f	k	g	n	b	z	l	w	z
l	p	q	h	k	m	o	q	k	d	x	g	r	t	y	c	x

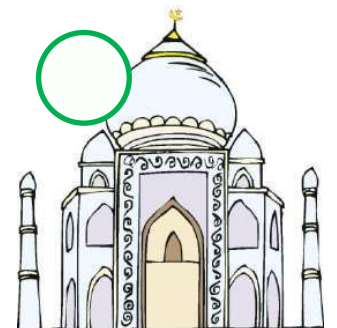
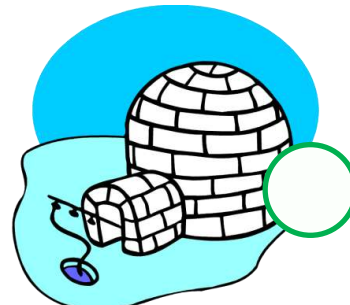
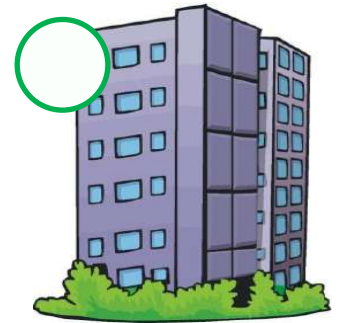
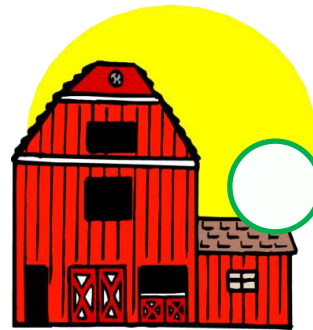
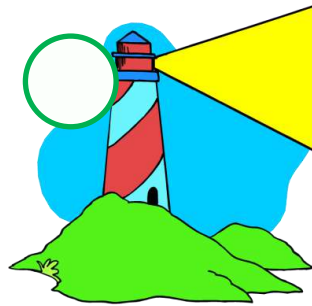
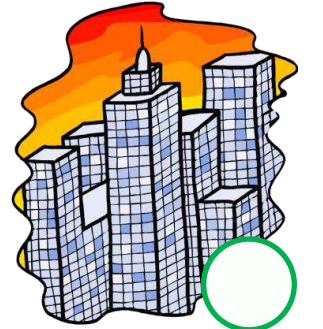
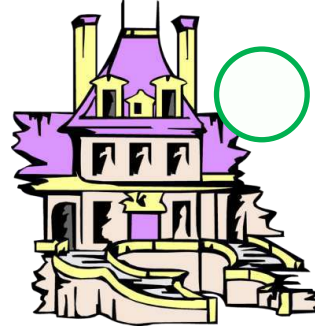
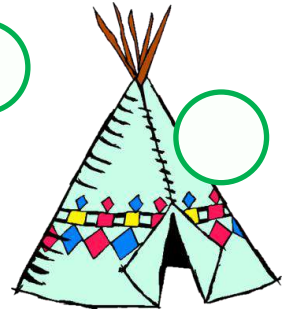

1. cottage
2. stilt house
3. igloo
4. farmhouse
5. hut
6. skyscraper
7. teepee
8. castle
9. palace
10. mansion
11. tent
12. cave
13. tree house
14. caravan
15. lighthouse
16. apartment building

HOUSES/HOMES VOCABULARY WORD SEARCH PUZZLE ANSWER KEY

Find and circle the words in the word search puzzle and number the pictures

g	h	g	m	h	t	t	g	q	d	p	a	e	q	d	i	u
h	y	s	p	z	h	e	p	p	x	n	p	a	o	i	i	u
u	o	q	w	v	a	n	y	x	n	s	a	k	m	b	k	r
t	g	n	s	z	u	t	l	y	v	q	r	f	a	k	o	w
l	a	k	x	r	t	w	s	v	b	h	t	z	n	u	c	f
i	n	t	e	e	p	e	e	h	t	f	m	k	s	p	x	s
g	t	k	r	b	y	a	l	m	r	a	e	s	i	a	z	t
h	s	k	y	s	c	r	a	p	e	r	n	c	o	l	k	i
t	p	w	r	c	o	h	e	a	e	m	t	a	n	a	k	l
h	v	c	a	s	t	l	e	g	h	h	b	r	y	c	s	t
o	c	a	v	e	t	x	e	r	o	o	u	a	f	e	s	h
u	j	m	e	f	a	t	s	y	u	u	i	v	i	v	k	o
s	d	s	d	i	g	l	o	o	s	s	l	a	m	x	u	u
e	w	p	m	j	e	u	i	u	e	e	d	n	z	i	w	s
g	e	q	o	a	z	j	w	l	w	o	i	w	z	o	h	e
i	f	e	q	c	a	o	r	f	k	g	n	b	z	l	w	z
l	p	q	h	k	m	o	q	k	d	x	g	r	t	y	c	x



14

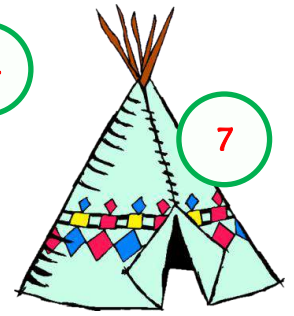

7



12



11



10

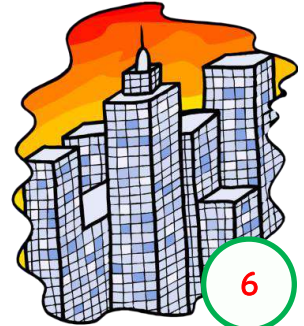

6

1. cottage
2. stilt house
3. igloo
4. farmhouse
5. hut
6. skyscraper
7. teepee
8. castle
9. palace
10. mansion
11. tent
12. cave
13. tree house
14. caravan
15. lighthouse
16. apartment building

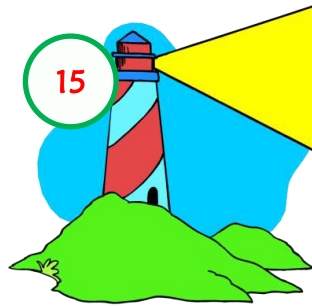

15



1

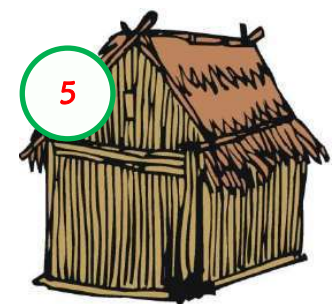

5



8

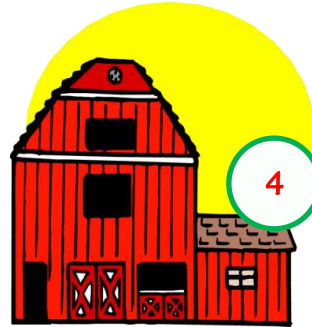

4

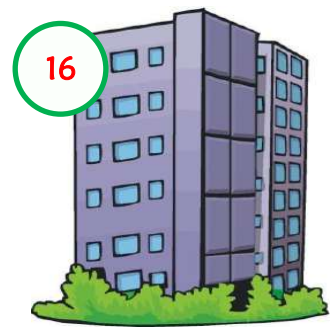

16



2



13

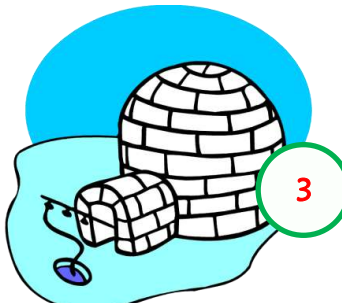

3

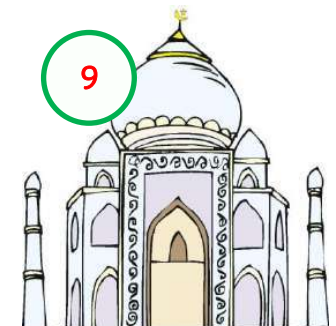

9

TYPES OF HOUSES CROSSWORD PUZZLE

Look at the numbers on the pictures and write the types of houses vocabulary in the crossword puzzle

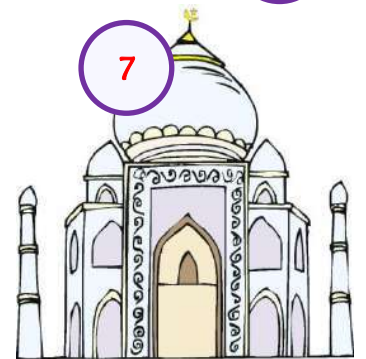
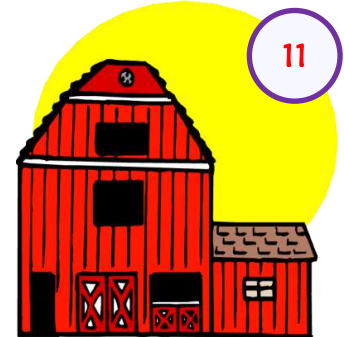
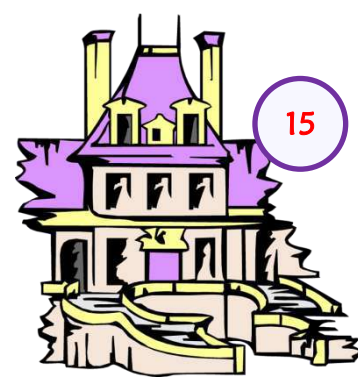
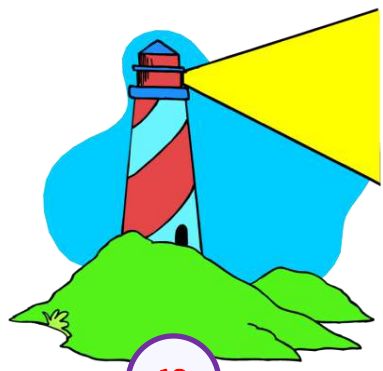
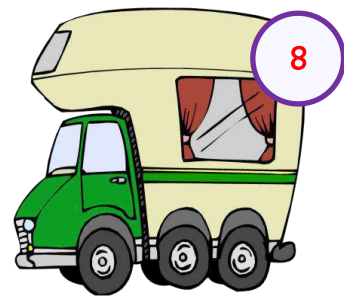
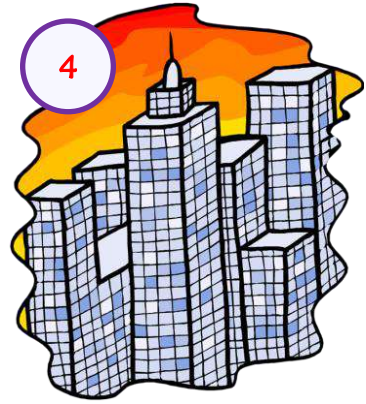
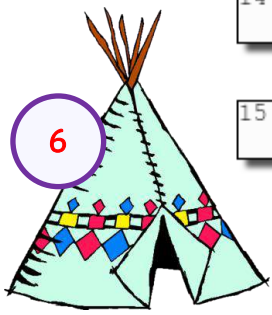
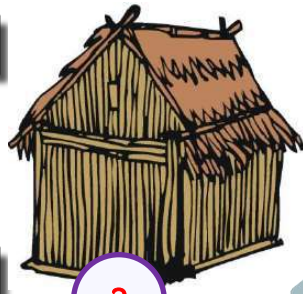
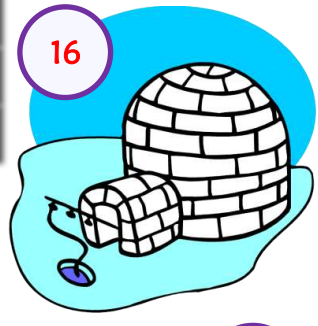
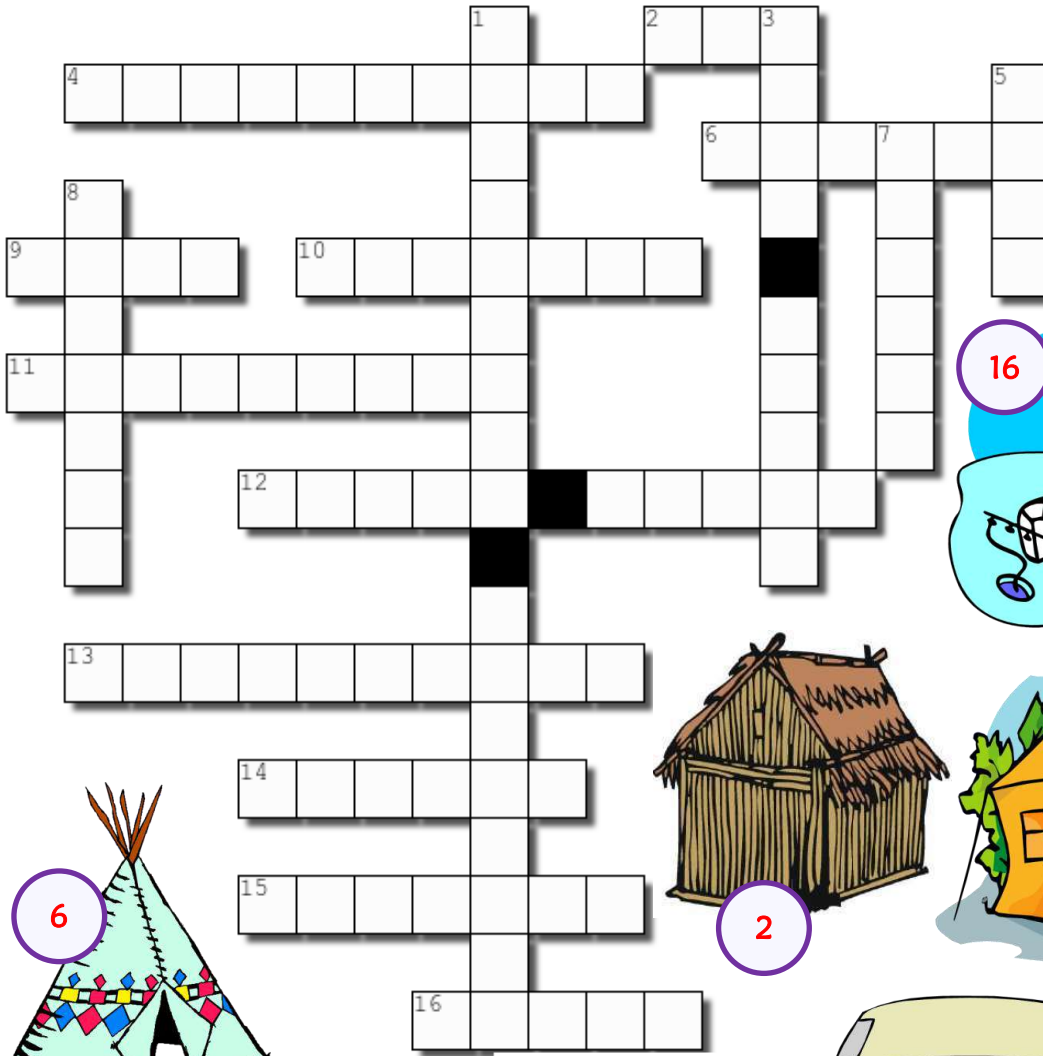

ANSWER KEY

Across

2. hut

4. skyscraper

6. teepee

9. cave

10. cottage

11. farmhouse

12. stilt house

13. lighthouse

14. castle

15. mansion

16. igloo

Down

1. apartment building

3. tree house

5. tent

7. palace

8. caravan

HOUSES/HOMES MISSING LETTERS IN WORDS

Write the missing letters in the boxes to complete the houses/homes vocabulary



c _ v _

tr _ _ h _ _ s _



h _ t



_ p _ rtm _ nt b _ _ ld _ ng



f _ r m h _ _ s _

c _ st l _



t _ nt



st _ lt h _ _ s _



l _ gh th _ _ s _

t _ _ p _ _



_ gl _ _

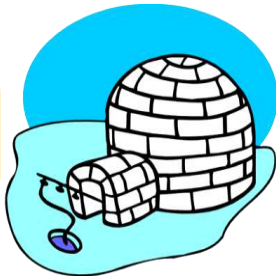

skyscr _ p _ r



m _ ns _ _ n

p _ l _ c _

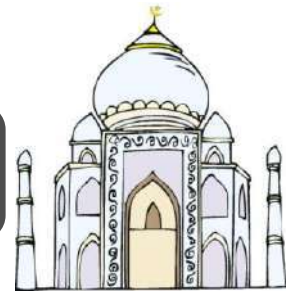

c _ tt _ g _



c _ r _ v _ n

HOUSES/HOMES MISSING LETTERS IN WORDS ANSWER KEY

Write the missing letters in the boxes to complete the houses/homes vocabulary



cave

tree house



hut



apartment building



farm house

castle



tent



stilt house



lighthouse

teepee



igloo

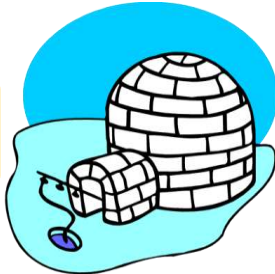

skyscraper



mansion

palace

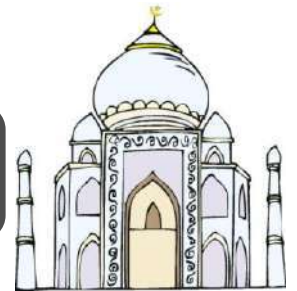

cottage



caravan

HOUSES/HOMES UNSCRAMBLE THE WORDS

Unscramble the houses/homes vocabulary and number the pictures

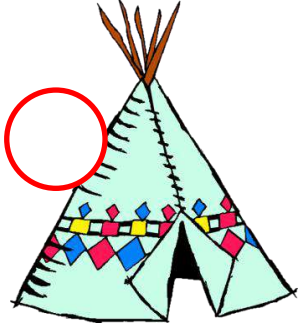
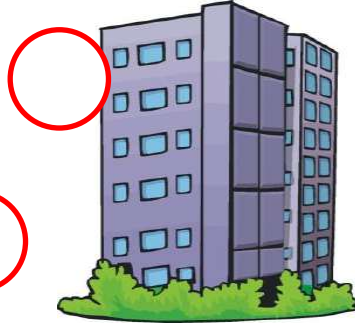
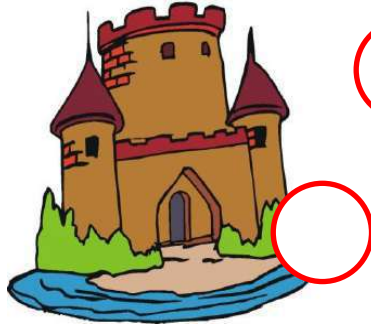

1. cgttaoe _____
2. sittl hoesu _____
3. ioogl _____
4. oeshmrafu _____
5. htu _____
6. pyrrssecka _____
7. eptee _____
8. cealst _____
9. apalec _____
10. aoninsm _____
11. etnt _____
12. avce _____
13. eert usheo _____
14. avrnaca _____
15. htiehsuol _____
16. ntmepatra indlgibu _____

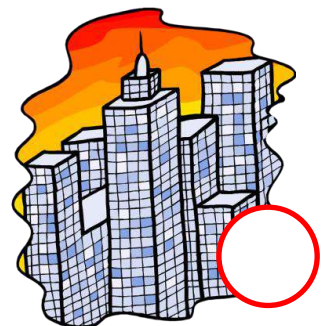
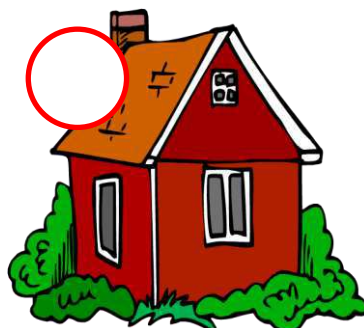
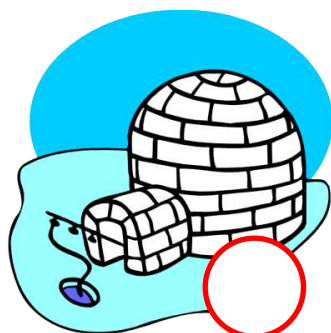
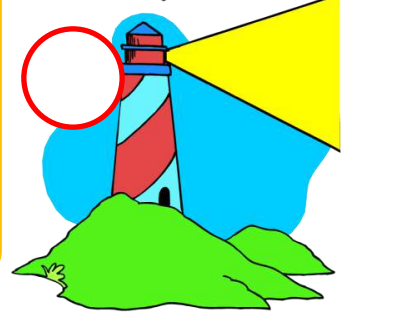
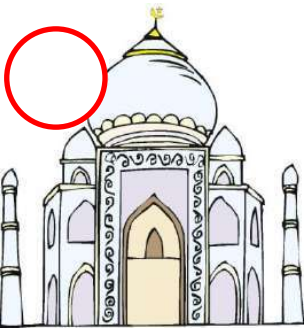
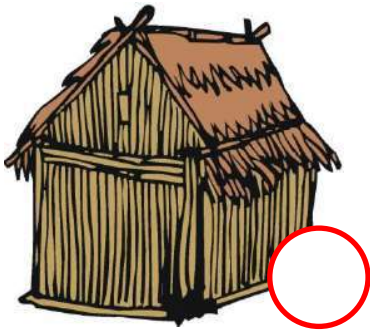
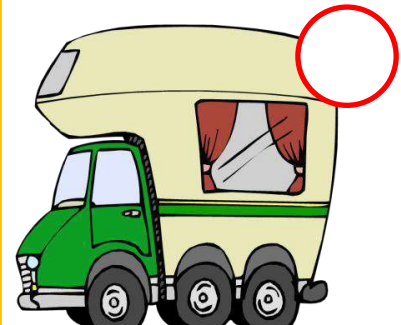
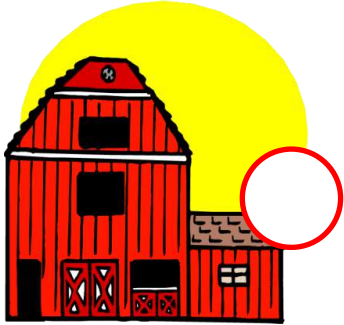
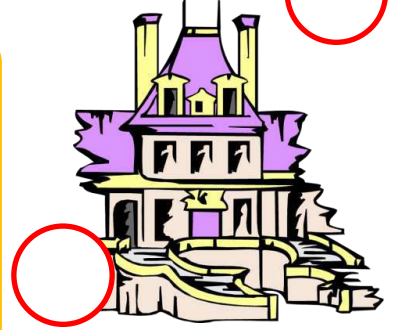

HOUSES/HOMES UNSCRAMBLE THE WORDS ANSWER KEY

Unscramble the houses/homes vocabulary and number the pictures

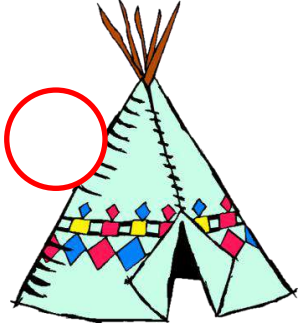
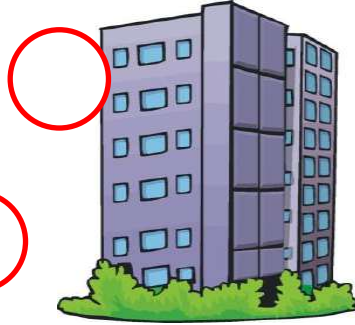
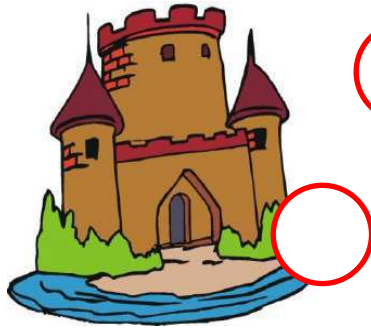

- | | |
|------------------------|--------------------|
| 1. cgttaoe | cottage |
| 2. sittl hoesu | stilt house |
| 3. ioogl | igloo |
| 4. oeshmrafu | farmhouse |
| 5. htu | hut |
| 6. pyrrssecka | skyscraper |
| 7. eptee | teepee |
| 8. cealst | castle |
| 9. apalec | palace |
| 10. aoninsm | mansion |
| 11. etnt | tent |
| 12. avce | cave |
| 13. eert usheo | tree house |
| 14. avrnaca | caravan |
| 15. htiehsuol | lighthouse |
| 16. ntmepatra indlgibu | apartment building |

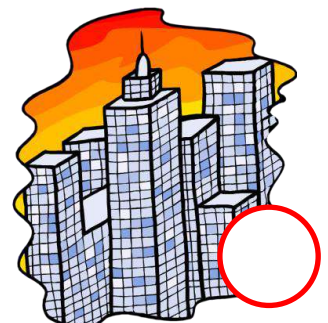
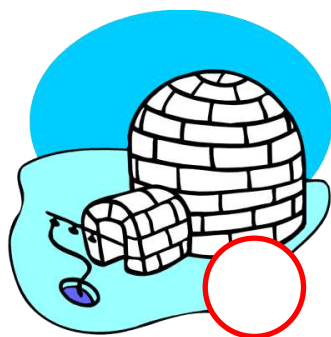
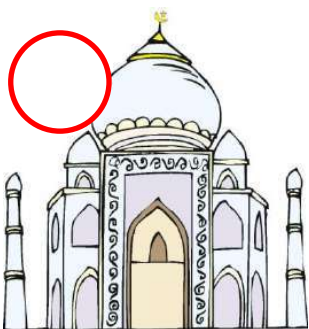
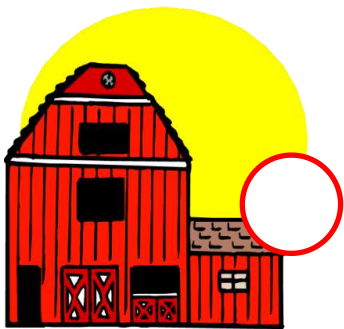
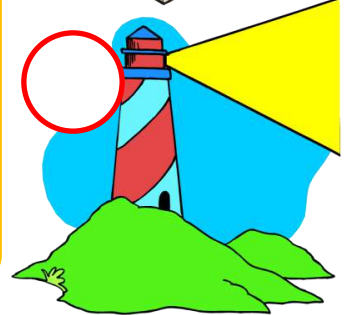
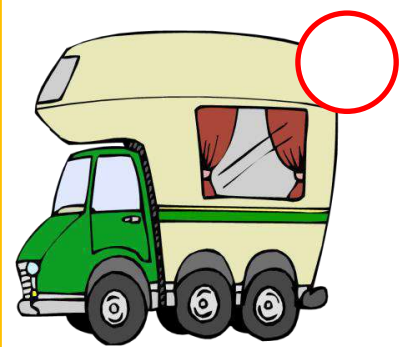
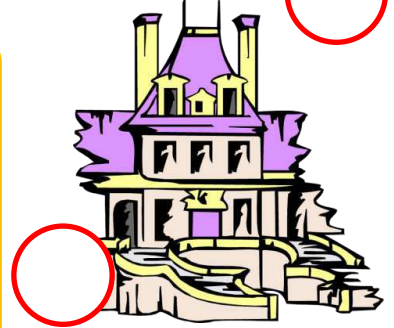

HOUSES/HOMES MULTIPLE CHOICE TEST

Look at the pictures, choose and circle the correct option.



- a) teepee
- b) mansion
- c) cottage
- d) lighthouse



- a) castle
- b) stilt house
- c) caravan
- d) tent

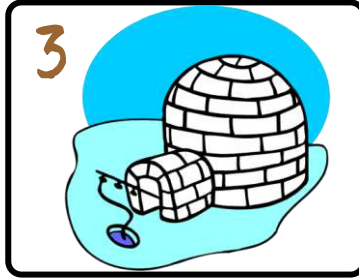

- a) igloo
- b) skyscraper
- c) cave
- d) tree house

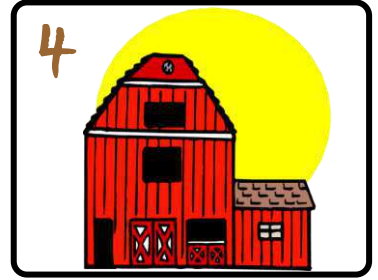

- a) farmhouse
- b) hut
- c) palace
- d) lighthouse



- a) cave
- b) igloo
- c) hut
- d) caravan

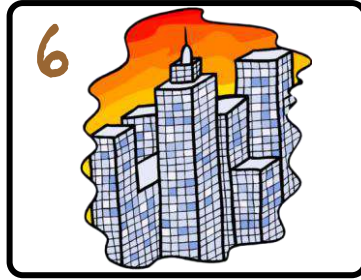

- a) tent
- b) skyscraper
- c) tree house
- d) cottage

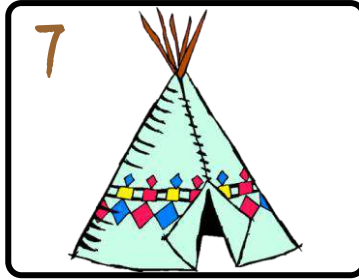

- a) palace
- b) lighthouse
- c) stilt house
- d) teepee



- a) mansion
- b) tree house
- c) farmhouse
- d) castle



- a) teepee
- b) palace
- c) farmhouse
- d) lighthouse

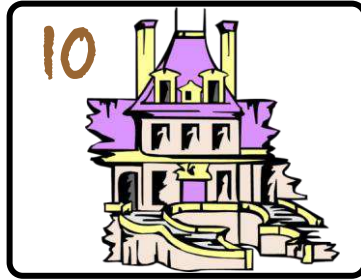

- a) tree house
- b) hut
- c) mansion
- d) cottage



- a) lighthouse
- b) tent
- c) skyscraper
- d) igloo

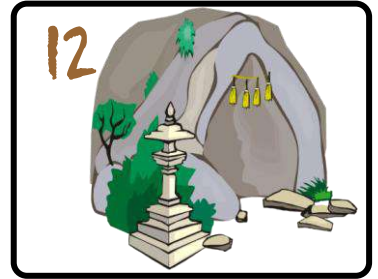

- a) cave
- b) igloo
- c) castle
- d) caravan



- a) apartment building
- b) stilt house
- c) skyscraper
- d) mansion

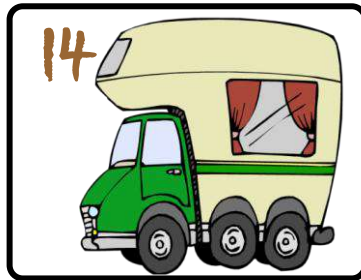

- a) hut
- b) cottage
- c) caravan
- d) palace



- a) castle
- b) farmhouse
- c) tent
- d) lighthouse



- a) teepee
- b) hut
- c) apartment building
- d) igloo

HOUSES/HOMES MULTIPLE CHOICE TEST ANSWER KEY

TEST 1

1) c

2) b

3) a

4) a

5) c

6) b

7) d

8) d

9) b

10) c

11) b

12) a

13) d

14) c

15) d

16) c



cottage



stilt house

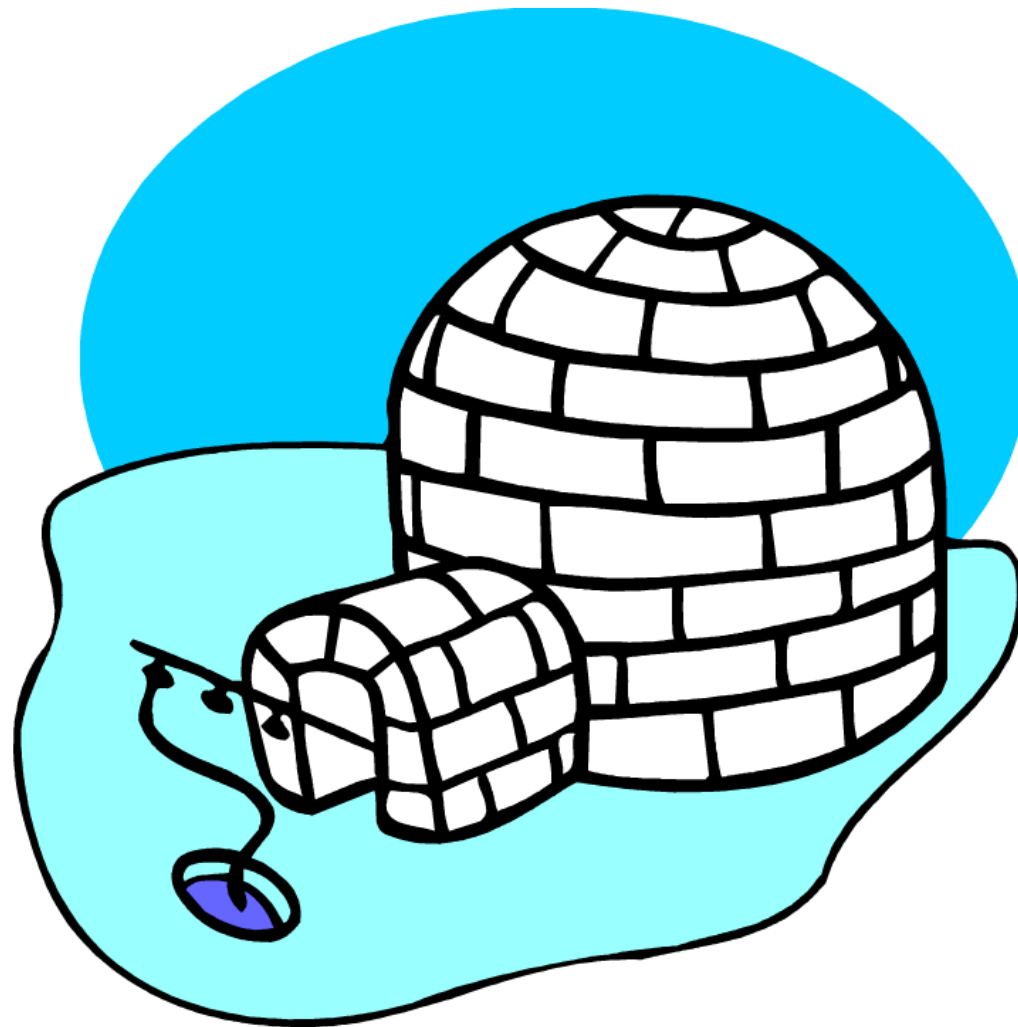

igloo



farmhouse



hut

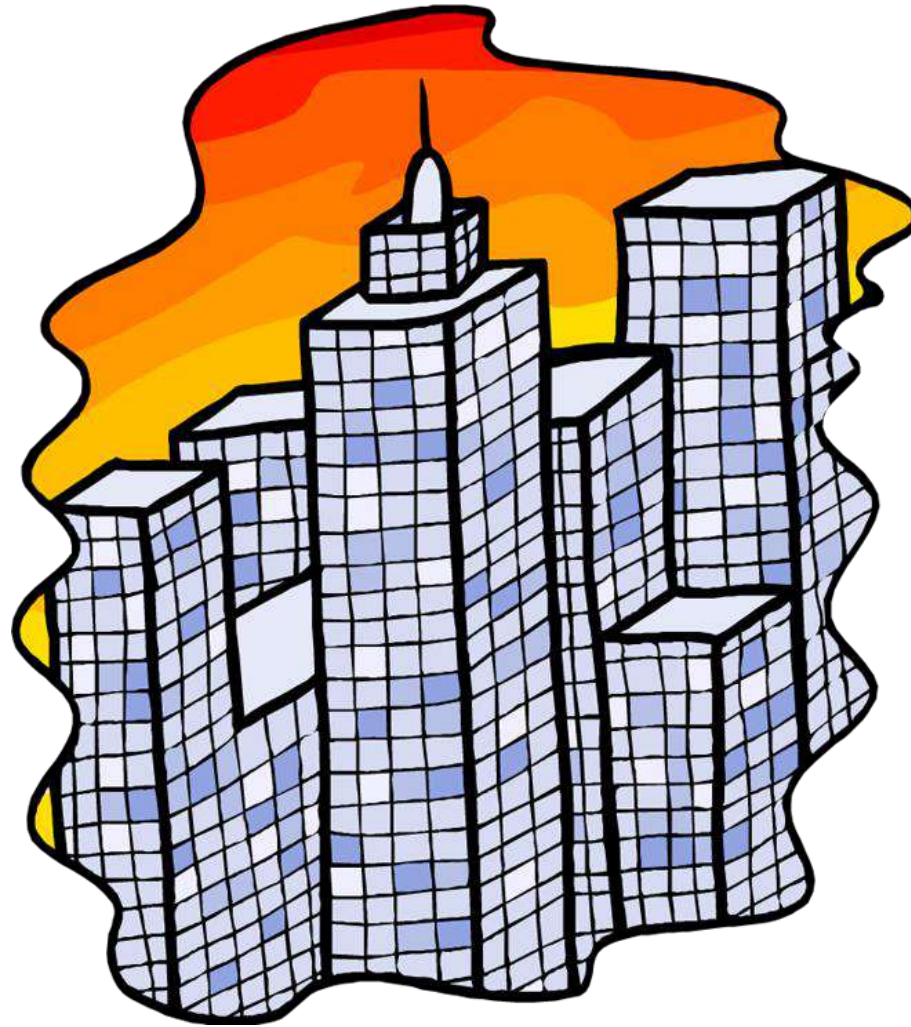

skyscraper

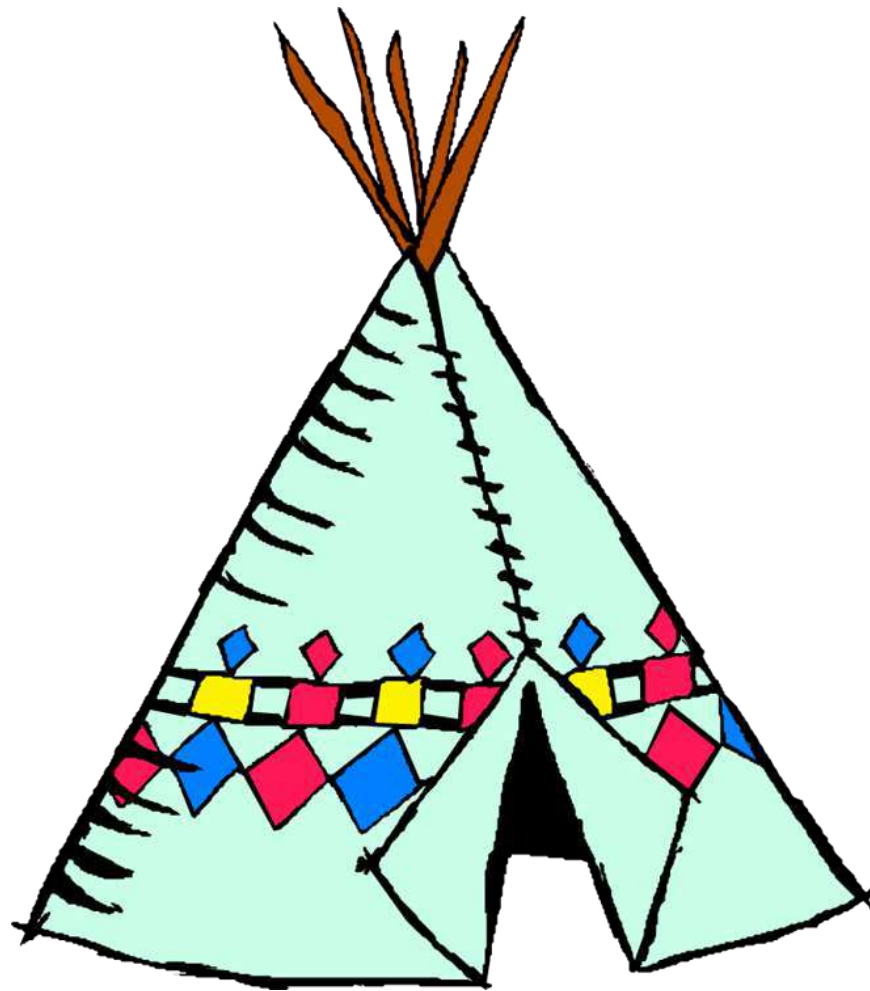

teepee



castle



palace



mansion



tent



cave



tree house



caravan



lighthouse

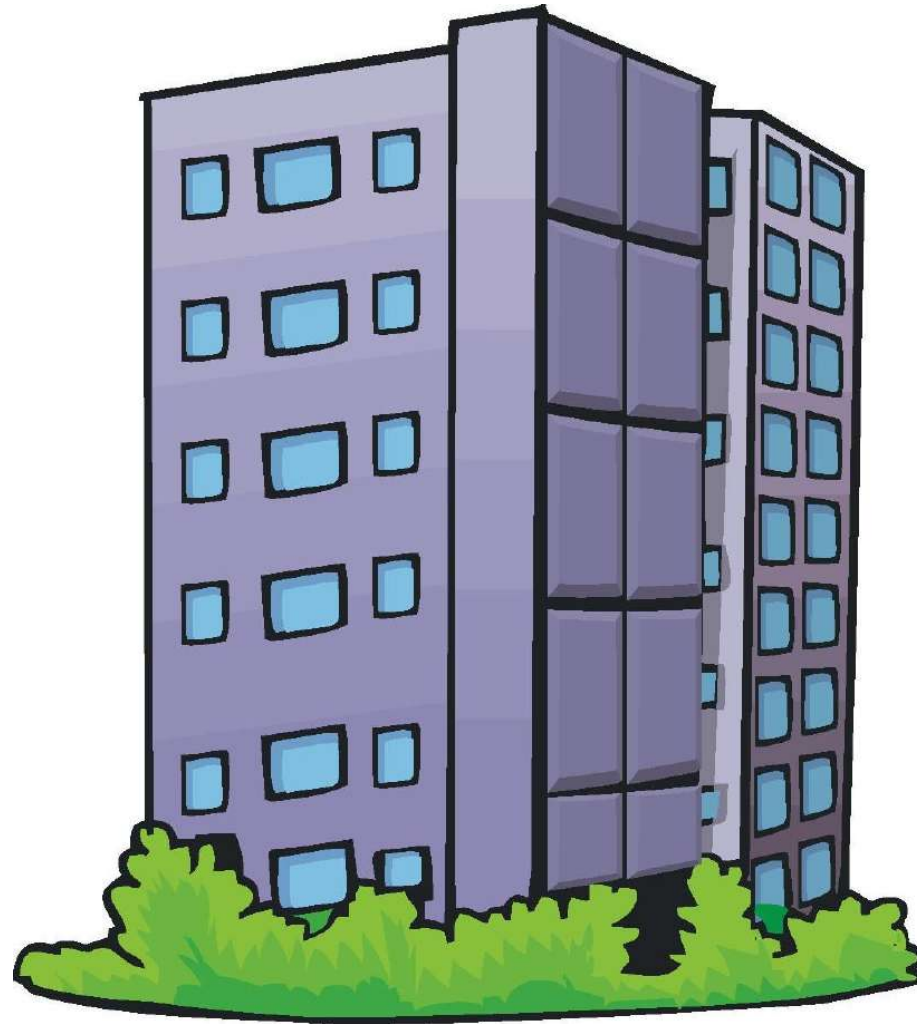

apartment building





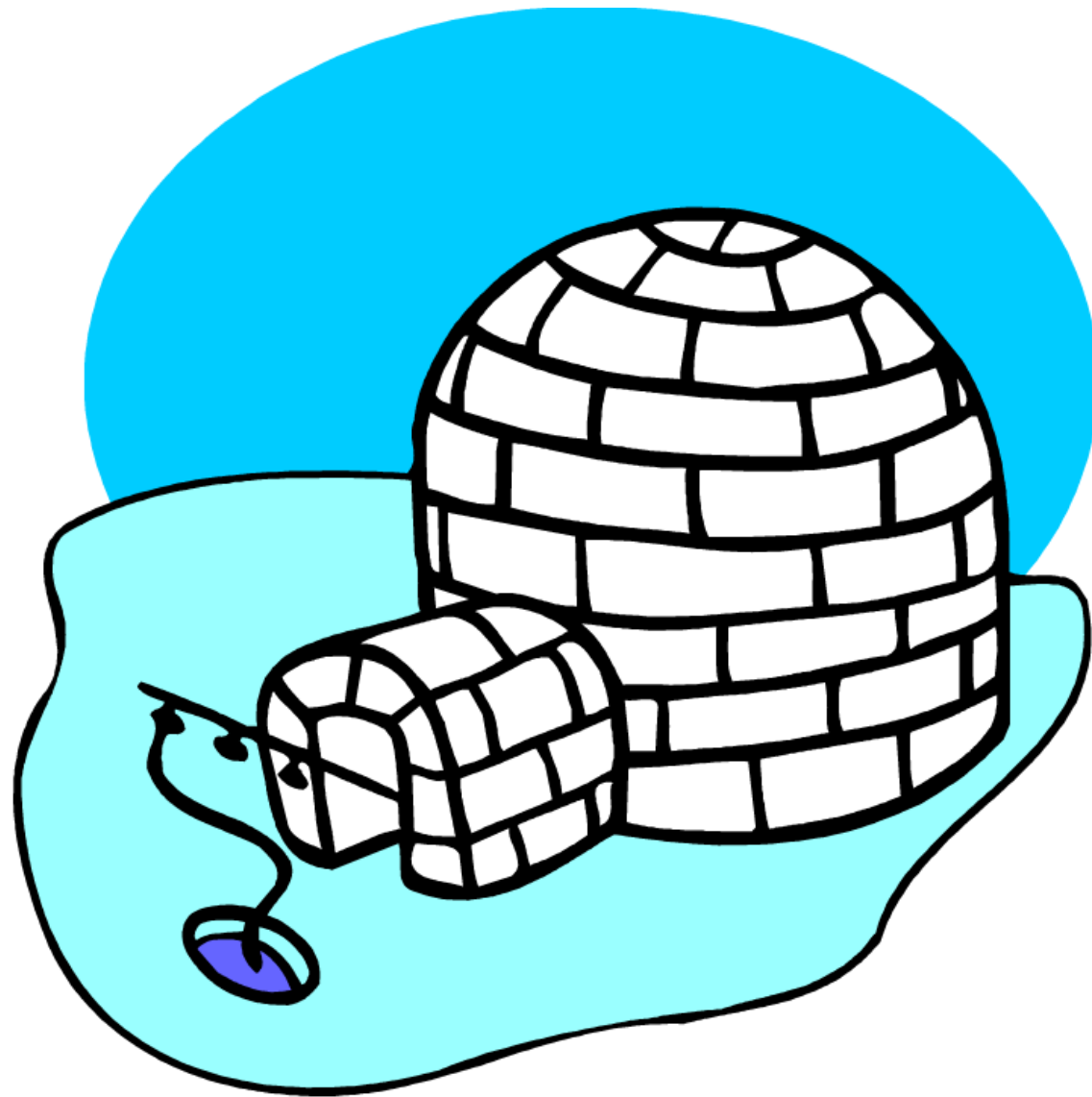





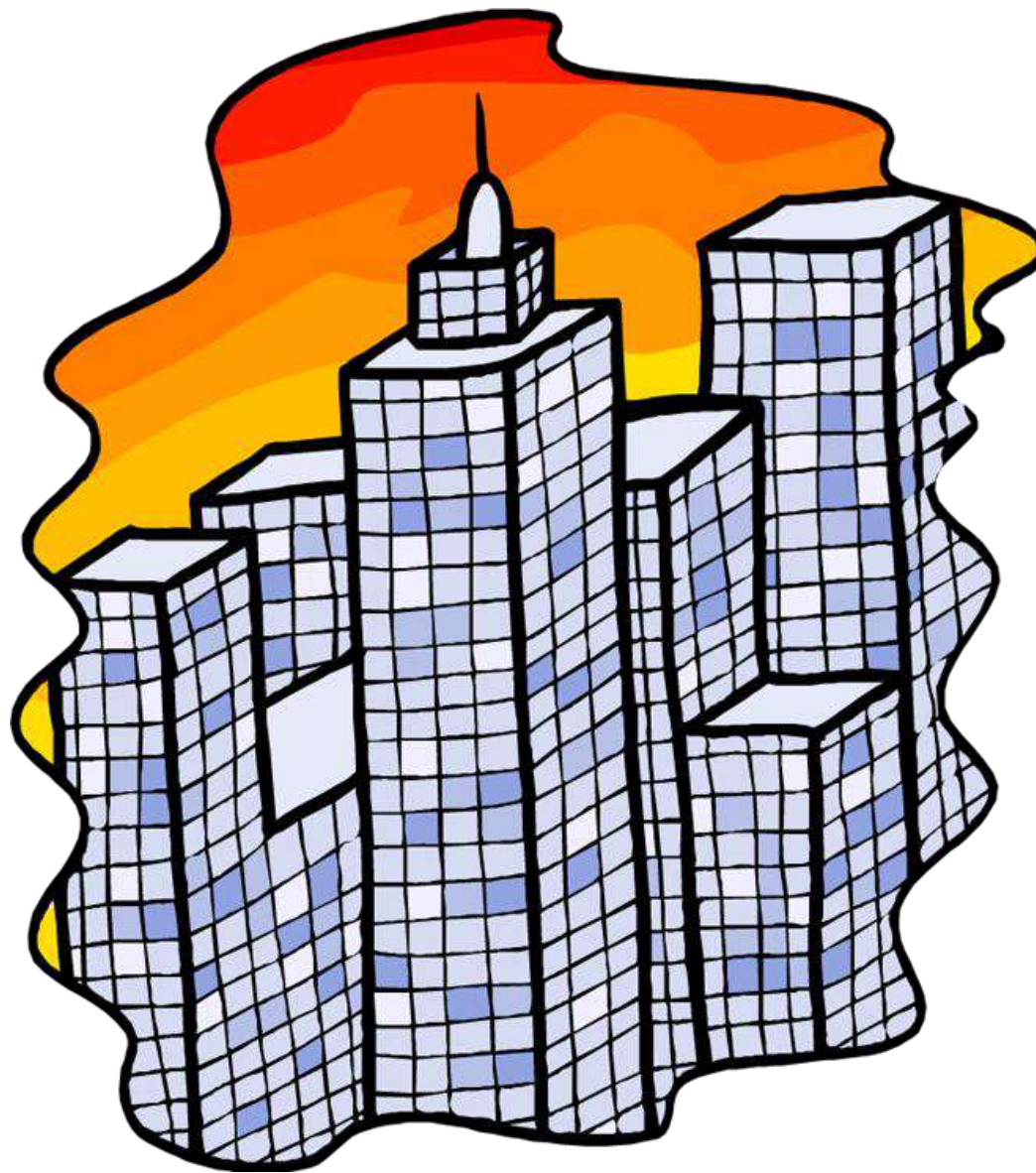



















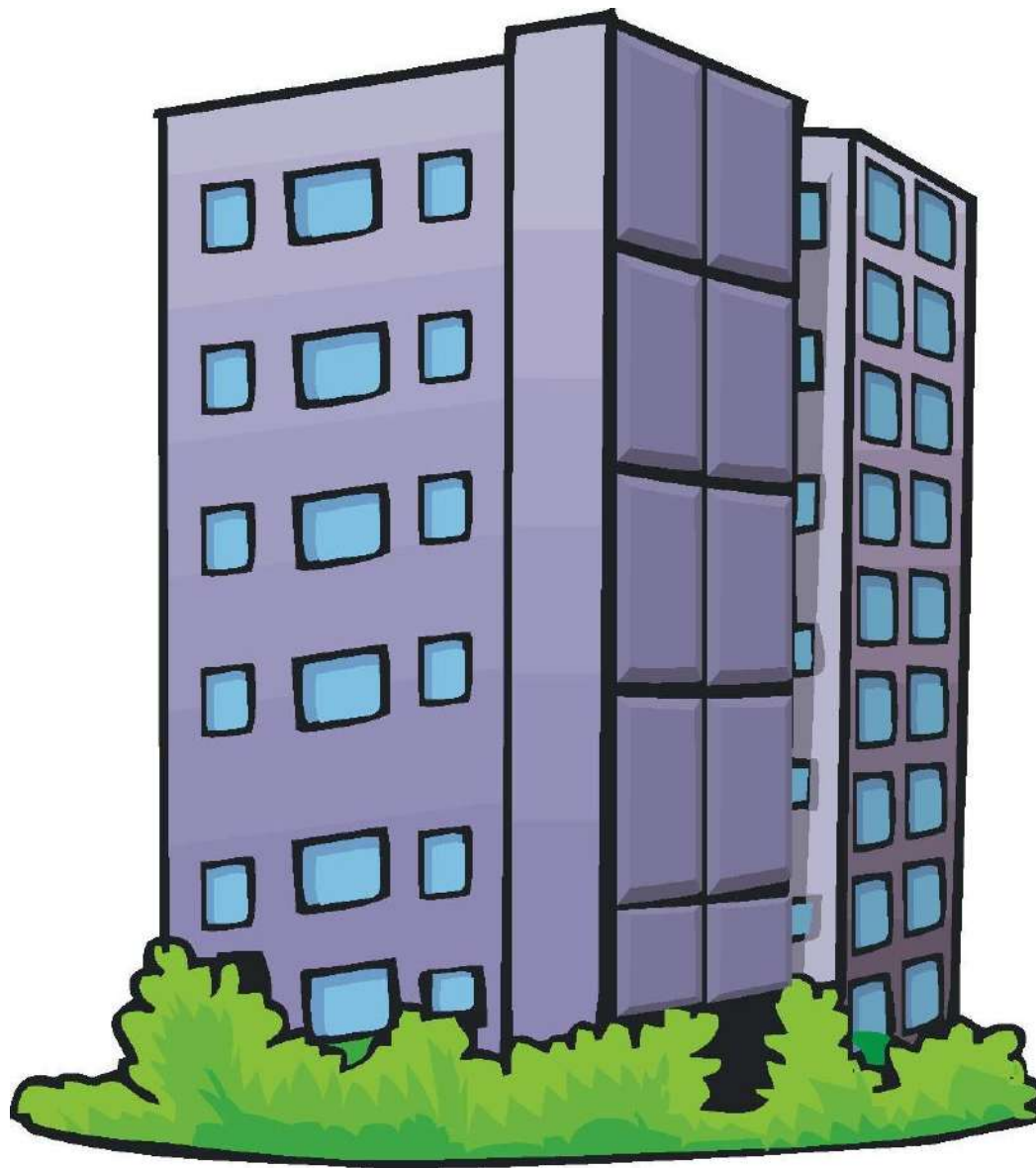



cottage

Copyright © 03/10/2019 englishsheets.com. All rights reserved.



stilt house

Copyright © 03/10/2019 englishsheets.com. All rights reserved.

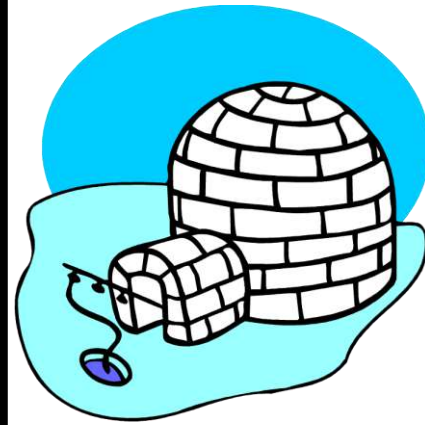

igloo

Copyright © 03/10/2019 englishsheets.com. All rights reserved.



farmhouse

Copyright © 03/10/2019 englishsheets.com. All rights reserved.



hut

Copyright © 03/10/2019 englishsheets.com. All rights reserved.

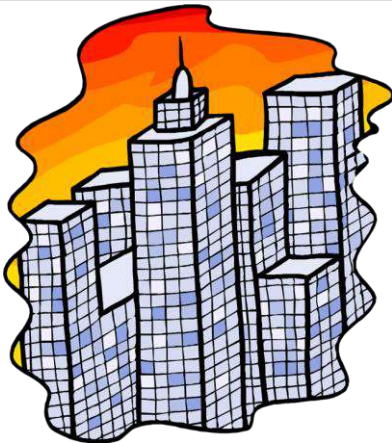

skyscraper

Copyright © 03/10/2019 englishsheets.com. All rights reserved.

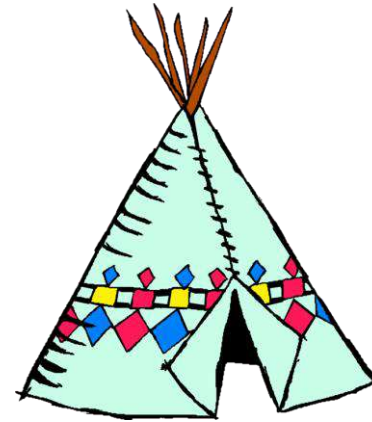

teepee

Copyright © 03/10/2019 englishsheets.com. All rights reserved.



castle

Copyright © 03/10/2019 englishsheets.com. All rights reserved.

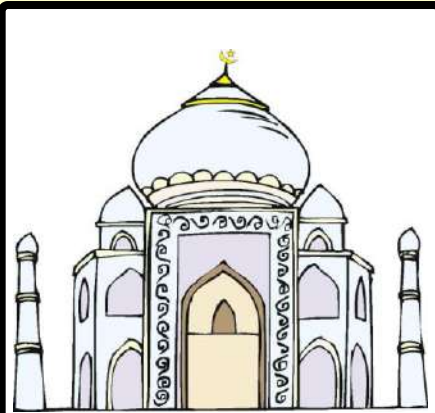

palace

Copyright © 03/10/2019 englishsheets.com. All rights reserved.

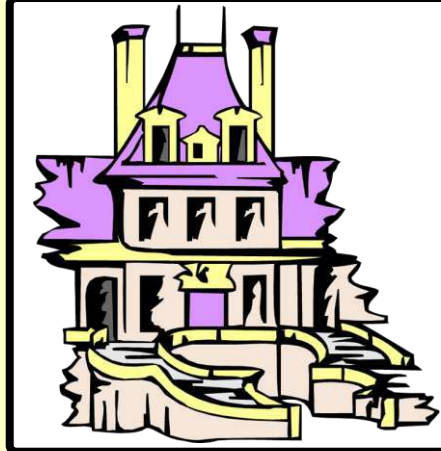

mansion

Copyright © 03/10/2019 englishsheets.com. All rights reserved.



tent

Copyright © 03/10/2019 englishsheets.com. All rights reserved.



cave

Copyright © 03/10/2019 englishsheets.com. All rights reserved.



tree house

Copyright © 03/10/2019 englishsheets.com. All rights reserved.

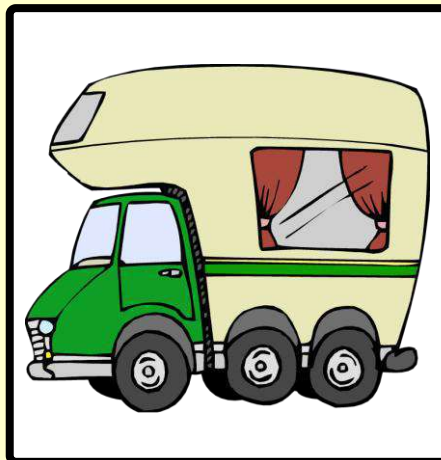

caravan

Copyright © 03/10/2019 englishsheets.com. All rights reserved.

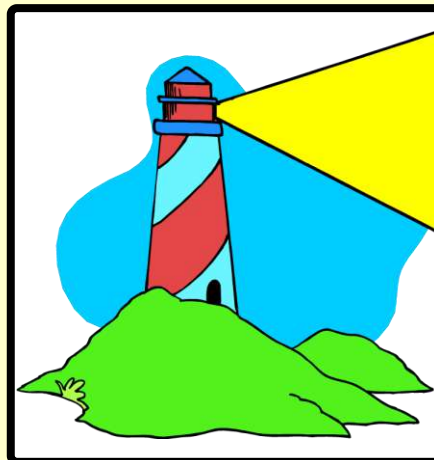

lighthouse

Copyright © 03/10/2019 englishsheets.com. All rights reserved.

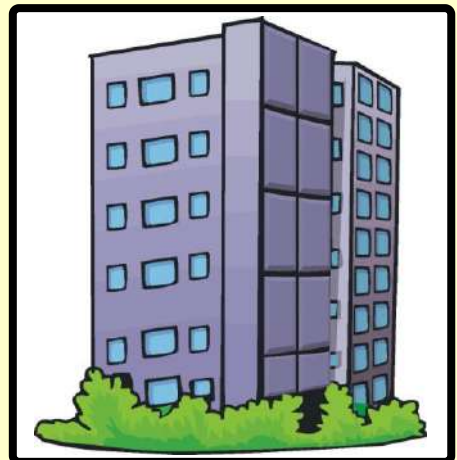

apartment building

Copyright © 03/10/2019 englishsheets.com. All rights reserved.

HOUSES FIDGET SPINNER GAME



- Cut a small arrow from paper or craft foam and stick it onto the fidget spinner as your pointer.
- Place the fidget spinner in the middle of the vocabulary circle.
- Spin it and say the word quickly!

HOUSES FIDGET SPINNER GAME



- Cut a small arrow from paper or craft foam and stick it onto the fidget spinner as your pointer.
- Place the fidget spinner in the middle of the vocabulary circle.
- Spin it and say the word quickly!



cottage



stilt house



igloo



farmhouse



hut



skyscraper

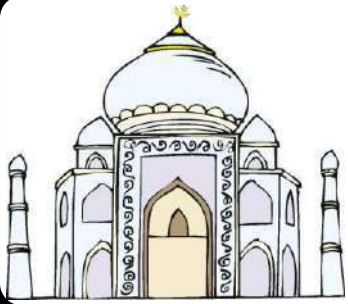

teepee



castle



palace



mansion



tent



cave

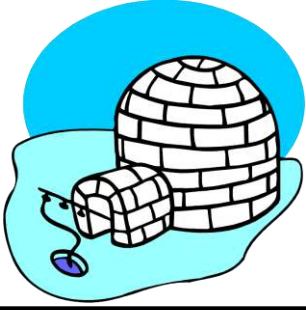

tree house



caravan



lighthouse



apartment
building

SLEEPING BEAUTY



Once upon a time there was a king and a queen. The queen had wanted a child for a very long time but couldn't have one.

One day the miracle finally happened and all the bells in the kingdom started ringing to announce the birth of a young princess. The king and the queen organized a huge celebration for the little girl's christening. All the seven fairy godmothers arrived to the royal party to give the little angel their gifts. As they were special guests, the royal family had prepared a gift for each of them. Laid on the table in front of each of the godmothers was a gold case, containing a knife, fork and spoon - all made of pure gold and set with rubies and diamonds.

As the guests were enjoying the celebration, the door opened with a crash. It was an old, hump-backed fairy, wearing black rags. The king immediately ordered to bring her gold tableware, but he couldn't give her a gold case, because he had only had seven of them made. The old woman thought that they didn't respect her enough and hissed some curse towards the newborn. Luckily, sitting next to her was a young and a very farsighted fairy, who noticed how fiercely the old woman was looking towards the baby. When the fairies left the table, she hurried to hide herself behind the curtains.

Soon the fairies gathered around the baby and one after another started giving their gifts in the form of a spell. The youngest of them wished for the princess to grow beautiful, the next one wished for the princess to have a kind and generous soul, the third wished for the princess to do everything with grace. The fourth wished for the girl to dance as light as a feather, the fifth one wished, "May she sing like a bird" and the sixth said, "May she play all musical instruments beautifully!". Next it was the old fairy's turn and she bent over the child "May you have your hand pierced with a spindle and die of the wound!" When she said her terrible spell, she grinned showing her ugly yellow teeth. At that moment the wise fairy godmother, who had been hiding behind the curtains, came out and said, "Calm down everyone! The princess won't die, but she will fall in a deep and long sleep, which will last for a hundred years, and when that period ends, a young prince will come and wake her up." When she saw that she was tricked, the old woman ran away crying because she couldn't do any more harm.

To avoid her daughter piercing her finger, the king went out and ordered that all women who owned or used a spindle to be killed.

Fifteen or sixteen years passed and nothing happened. But one day the young princess was wandering around the castle and noticed something very curious while climbing up the tower. In a small room there was an old lady, spinning her spindle. "What are you doing madam?" the princess asked and the old woman replied, "I am spinning, your highness." The princess found the activity really interesting and decided to try it. But as soon as she took the spindle, the end pierced the princess's finger and she fainted on the floor. The old

lady cried for help. In a moment help came and they tried to revive her. Someone sprinkled her face with water, another loosened her clothes, a third massaged her arms, but despite all this the princess lay still. The king arrived and at the sight of his daughter, he remembered the old fairy godmother's spell. The time had come and the king ordered the princess to be laid on a bed embroidered with gold and silver. As she slept, her beauty remained vivid and she looked like an angel.

The farsighted fairy godmother that had saved the girl's life was told what had happened. She rushed to reach the kingdom as fast as possible, because she was twelve thousand miles away. When she arrived the king helped her out of her magic coach. When the fairy godmother saw what had been done by the time she arrived, she was impressed. However, the thought of the princess waking up a hundred years later, surrounded by people she didn't know terrified the fairy, and so she put everyone in the kingdom into a deep sleep. Nannies, servants, noblemen, butlers, soldiers and even the princess's small puppy went to sleep. Then the king and the queen wiped their tears away, kissed their child and gave the orders that no one should approach the castle. In less than fifteen minutes thick and dark woods and bushes grew before the eyes of the king and the queen. No one could see the castle and even if they saw it no one would have the courage to enter.

The years passed and the king and the queen passed away. The kingdom was still and not a single sound could be heard from its halls and chambers. The princess was still sleeping. One day, a hundred years later, a young prince was passing by the enchanted wood when he suddenly saw something he had never seen before - through the trees he could see the towers. He asked a passer-by what they were.

"I am not sure, my lord, but I remember that my father once told me a story about the most beautiful princess in the world, who was cursed to fall into a deep sleep for a hundred years. One prince has been chosen to be the only one who can wake her up."

At the news the brave prince went into the woods and fought for a long time with branches and roots. As soon as he got past one tree, the woods would close up behind him. He found this scary but spurred himself on with the thought that he might be the chosen prince from the story.

The prince finally reached the castle. He was shocked to see people sleeping everywhere! Judging by their clothes, they had been there for a century! He didn't give up and started searching the rooms one after another until he finally found her. A fifteen or sixteen-year old princess was lying in a bed. The prince went to the bed and kissed the princess. She opened her beautiful eyes and smiled at him. "I have been waiting for you to come," she said, "What took you so long?"

Everyone else in the kingdom woke up at the same time. They all went back to work. The prince and the princess organised a lavish wedding and invited the whole kingdom to it. There was food and drinks for everyone. The brave prince married the beautiful princess and they both lived happily ever after.

SLEEPING BEAUTY



COMPREHENSION QUESTIONS

1. What did the queen want for a very long time?
2. Did the royal family prepare anything for their special guests?
3. What did the fairy godmothers give the newborn as a gift?
4. Why did the old woman got so angry ?
5. Who changed the evil spell of the old woman?
6. How many years would she sleep if a spindle pierced her hand?
7. Did the girl's father and mother fell into a deep sleep as well?
8. Did the prince know the story of the girl before he noticed the castle?
9. What did the prince do to wake the princess up?

WRITE TRUE OR FALSE

1. _____ The king and the queen had sons, but they also wanted a daughter.
2. _____ The old woman couldn't do any more harm thanks to the wise fairy.
3. _____ The girl was fifteen or sixteen years old when she tried the spindle.
4. _____ Only the girl fell into a deep sleep in the story.
5. _____ The prince could not easily reach the castle because of the branches and roots.

CIRCLE THE CORRECT CHOICE

1. fairy godmothers were the royal family's special guests.
Six / Seven / Eight
2. The king and the queen's gift for the fairy godmothers was
a gold case / a silver plate / a diamond ring
3. The girl wanted to try the when she saw the old woman in the tower.
swing / slide / swindle
4. The girl's parents were when she finally woke up from her sleep.
at home / already dead / so excited
5. The girl was the prince when she she finally opened her eyes.
waiting for / not expecting / dancing

ANSWER KEY

Comprehension Questions

1. She wanted a child for a very long time.
2. Yes, they did.
3. They gave their gifts in the form of spells.
4. Because she thought that they didn't respect her enough.
5. The wise fairy changed the evil spell of the old woman.
6. She would sleep for a hundred years if a spindle pierced her hand.
7. No, they didn't.
8. No, he didn't.
9. He kissed the princess to wake her up.

Write True or False

1. False
2. True
3. True
4. False
5. True

Circle the Correct Choice

1. Seven
2. a gold case
3. swindle
4. already dead
5. waiting for

SLEEPING BEAUTY

Read the texts in the boxes and number them from 1 to 9 to sequence the fairy tale



The king ordered that all women who owned or used a spindle to be killed, but the girl had her finger pierced by a spindle in one of the chambers when she was fifteen or sixteen.



They organized a celebration and invited all the seven fairy godmothers, so that they could give their gifts to the newborn. The day came and all the seven fairies arrived.

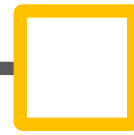

She became angry because she wasn't given a special gift and thought that she wasn't respected. After dinner all the fairies gathered and gave their special gifts to the baby in the forms of spells.



Once upon a time there was a king and a queen. The queen had always wanted a child but couldn't have one. One day a miracle happened and they had a baby girl.



After a hundred years, a passing by prince learned her story and decided to go into the castle. He finally found the princess and kissed her. She woke up and they got married.

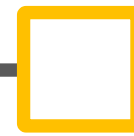

She wouldn't die, but she would sleep for a hundred years, if her hand was pierced with a spindle. After a century, a prince would come and wake her up.

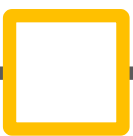

She fell into a deep sleep. Then the fairy godmother came and put everyone else in a deep sleep as well, except her parents. They passed away some time later.



The king and queen had prepared each of them a precious gift as they were special guests. They were at the table when an old and vicious fairy came.



Next the old fairy said her terrible spell. The girl would die of a wound if her hand was pierced with a spindle. Luckily, the wise fairy came and changed the spell.

SLEEPING BEAUTY

Read the texts in the boxes and number them from 1 to 9 to sequence the fairy tale



7

The king ordered that all women who owned or used a spindle to be killed, but the girl had her finger pierced by a spindle in one of the chambers when she was fifteen or sixteen.

2

They organized a celebration and invited all the seven fairy godmothers, so that they could give their gifts to the newborn. The day came and all the seven fairies arrived.

4

She became angry because she wasn't given a special gift and thought that she wasn't respected. After dinner all the fairies gathered and gave their special gifts to the baby in the forms of spells.

1

Once upon a time there was a king and a queen. The queen had always wanted a child but couldn't have one. One day a miracle happened and they had a baby girl.

9

After a hundred years, a passing by prince learned her story and decided to go into the castle. He finally found the princess and kissed her. She woke up and they got married.

6

She wouldn't die, but she would sleep for a hundred years, if her hand was pierced with a spindle. After a century, a prince would come and wake her up.

8

She fell into a deep sleep. Then the fairy godmother came and put everyone else in a deep sleep as well, except her parents. They passed away some time later.

3

The king and queen had prepared each of them a precious gift as they were special guests. They were at the table when an old and vicious fairy came.

5

Next the old fairy said her terrible spell. The girl would die of a wound if her hand was pierced with a spindle. Luckily, the wise fairy came and changed the spell.