

SPACE PICTURE DICTIONARY



Sun



Earth



Moon



planet

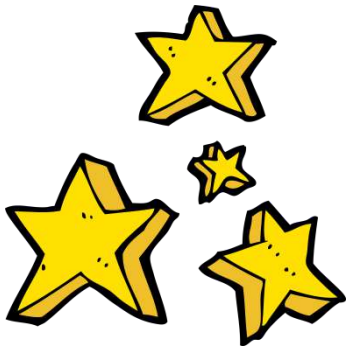

stars



asteroid



meteorite

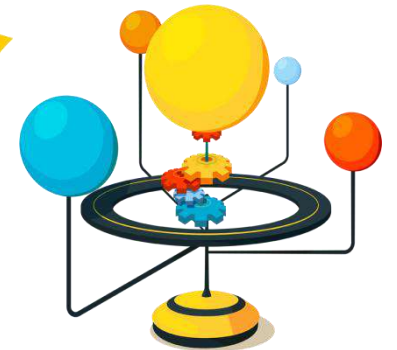

solar system

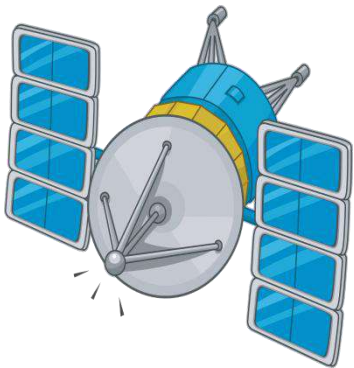

satellite



shuttle



rocket



astronaut



ufo

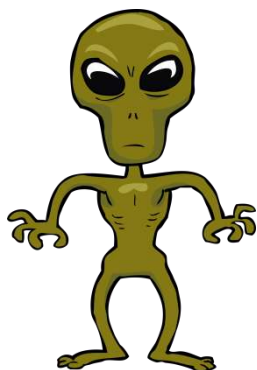

alien



telescope



observatory

SPACE VOCABULARY MATCHING WORKSHEET

Choose the correct words from the list below and write them under the correct pictures

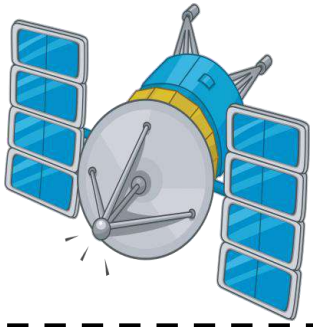

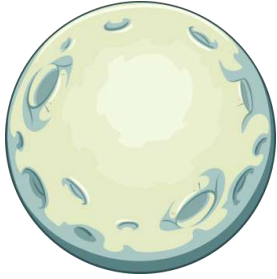

WORD LIST

- Sun
- Earth
- Moon
- planet
- stars
- asteroid
- meteorite
- solar system
- satellite
- shuttle
- rocket
- astronaut
- ufo
- alien
- telescope
- observatory





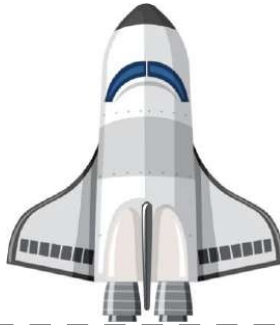
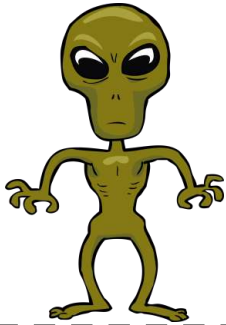
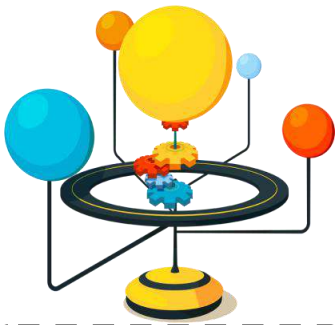

SPACE VOCABULARY MATCHING WORKSHEET ANSWER KEY

Choose the correct words from the list below and write them under the correct pictures



planet

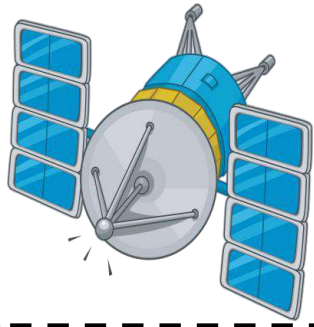

satellite



stars



observatory



meteorite

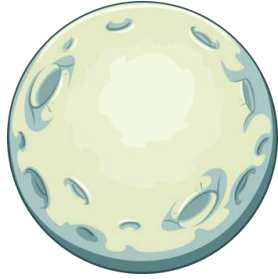

Moon

WORD LIST

- Sun
- Earth
- Moon
- planet
- stars
- asteroid
- meteorite
- solar system
- satellite
- shuttle
- rocket
- astronaut
- ufo
- alien
- telescope
- observatory



astronaut



telescope



ufo



Sun



asteroid



rocket

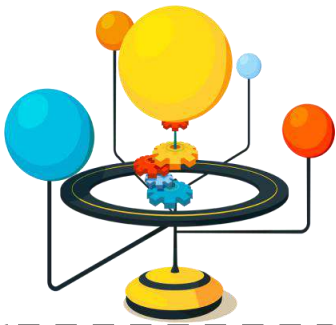

solar system



alien

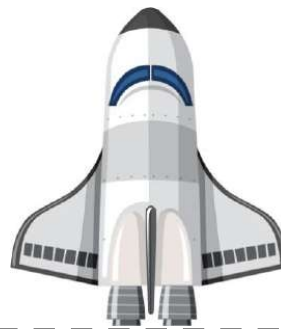

shuttle



Earth

SPACE VOCABULARY WORD SEARCH PUZZLE

Find and circle the words in the word search puzzle and number the pictures

s	h	u	t	t	l	e	t	u	m	j	z	h	b	y
s	s	h	s	t	a	r	s	f	e	q	b	t	q	z
u	e	v	o	q	n	q	n	o	t	w	n	e	m	x
n	l	a	l	i	e	n	w	p	e	v	k	l	m	u
e	a	d	a	p	t	z	m	o	o	n	e	e	b	m
a	s	t	r	o	n	a	u	t	r	g	i	s	i	l
r	b	a	s	r	q	r	g	h	i	s	p	c	d	w
t	j	s	y	x	l	o	m	j	t	x	l	o	h	n
h	n	t	s	q	o	c	j	j	e	e	a	p	r	f
i	o	e	t	a	f	k	y	j	t	p	n	e	x	r
b	x	r	e	w	c	e	f	i	e	u	e	d	b	r
p	y	o	m	s	a	t	e	l	i	t	e	l	b	
y	a	i	d	o	b	s	e	r	v	a	t	o	r	y
s	h	d	e	z	a	f	s	t	t	w	x	o	n	a
e	r	l	z	b	m	s	v	x	c	f	e	w	q	i

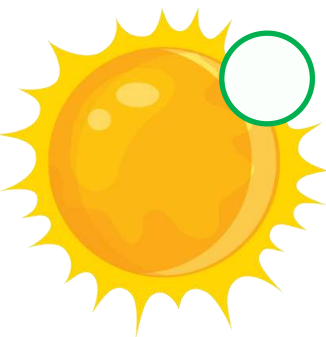
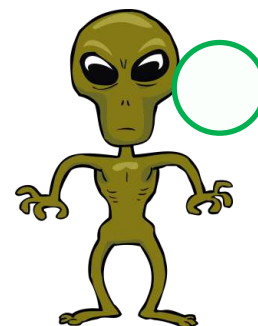
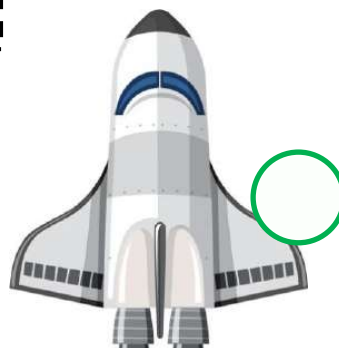
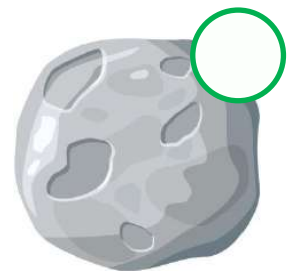
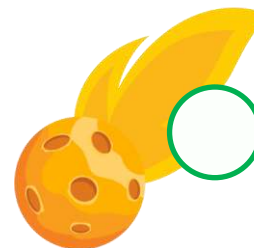
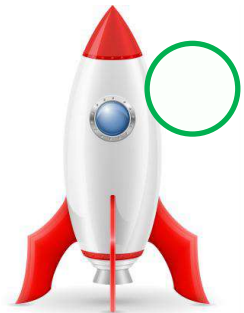
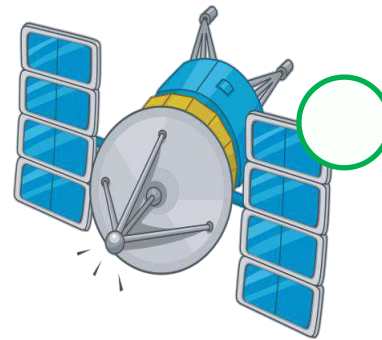
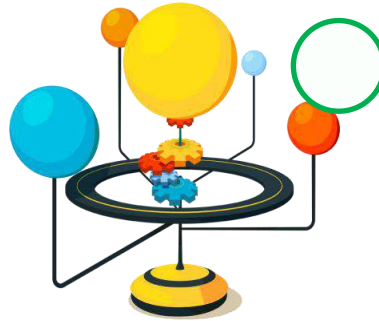
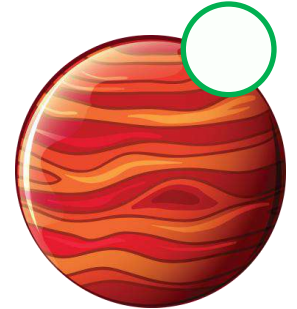
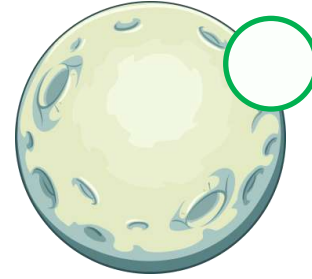
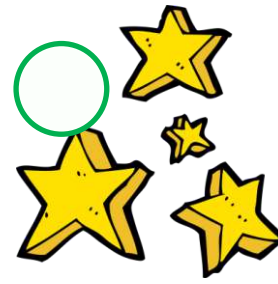

1. Sun
2. Earth
3. Moon
4. planet
5. stars
6. asteroid
7. meteorite
8. solar system
9. satellite
10. shuttle
11. rocket
12. astronaut
13. ufo
14. alien
15. telescope
16. observatory

SPACE VOCABULARY WORD SEARCH PUZZLE ANSWER KEY

Find and circle the words in the word search puzzle and number the pictures

s	h	u	t	t	l	e	t	u	m	j	z	h	b	y
s	s	h	s	t	a	r	s	f	e	q	b	t	q	z
u	e	v	o	q	n	q	n	o	t	w	n	e	m	x
n	l	a	l	i	e	n	w	p	e	v	k	l	m	u
e	a	d	a	p	t	z	m	o	o	n	e	e	b	m
a	s	t	r	o	n	a	u	t	r	g	i	s	i	l
r	b	a	s	r	q	r	g	h	i	s	p	c	d	w
t	j	s	y	x	l	o	m	j	t	x	l	o	h	n
h	n	t	s	q	o	c	j	j	e	e	a	p	r	f
i	o	e	t	a	f	k	y	j	t	p	n	e	x	r
b	x	r	e	w	c	e	f	i	e	u	e	d	b	r
p	y	o	m	s	a	t	e	l	i	t	e	l	b	
y	a	i	d	o	b	s	e	r	v	a	t	o	r	y
s	h	d	e	z	a	f	s	t	t	w	x	o	n	a
e	r	l	z	b	m	s	v	x	c	f	e	w	q	i

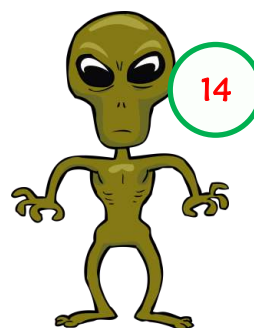
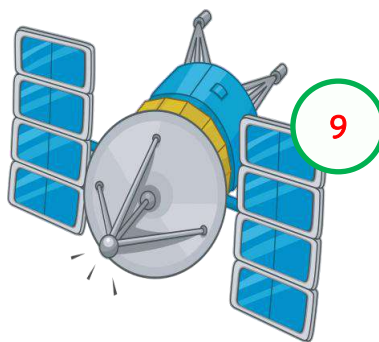
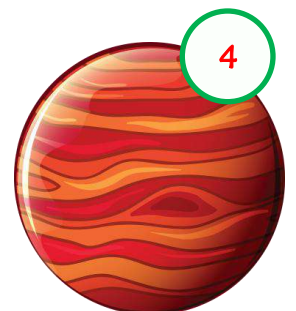
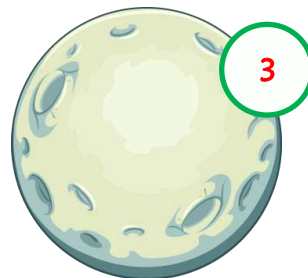

1. Sun
2. Earth
3. Moon
4. planet
5. stars
6. asteroid
7. meteorite
8. solar system
9. satellite
10. shuttle
11. rocket
12. astronaut
13. ufo
14. alien
15. telescope
16. observatory

SPACE CROSSWORD PUZZLE

Look at the numbers on the pictures and write the space vocabulary in the crossword

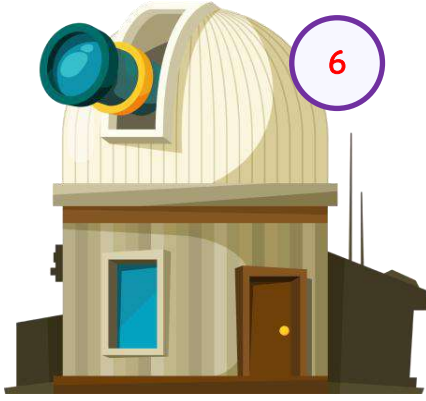

6



1

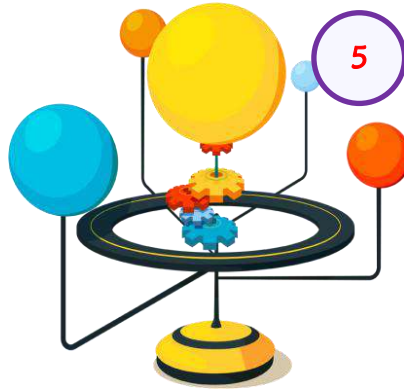

5

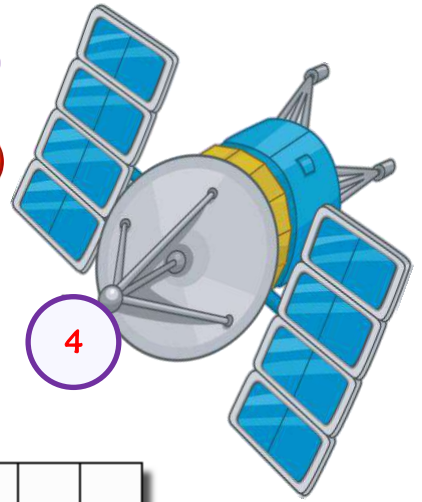

4



2



3

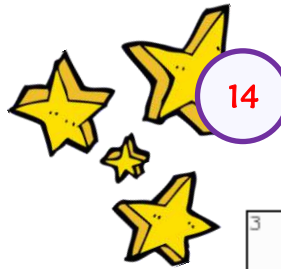

14

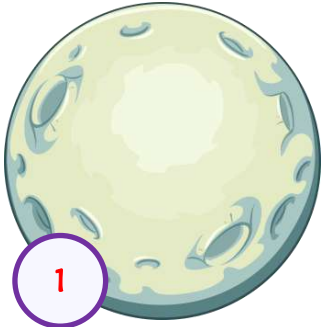
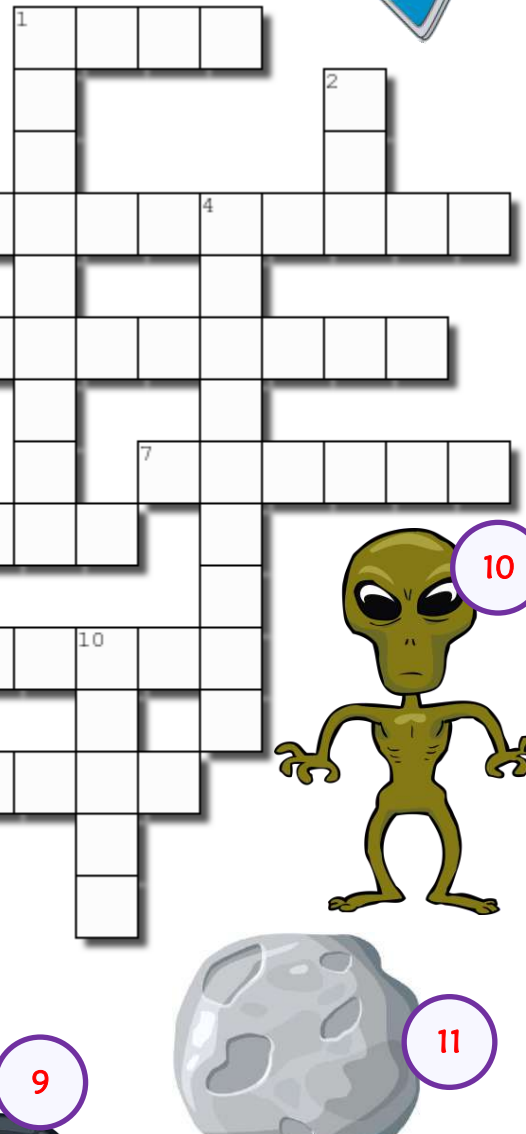

1

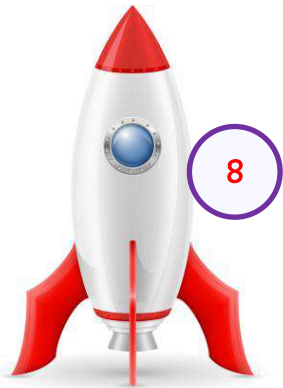

8

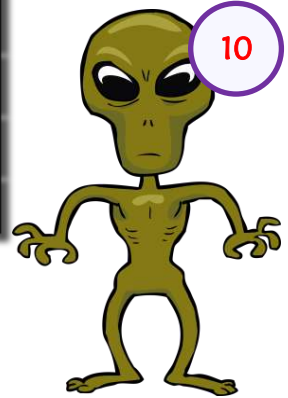

10

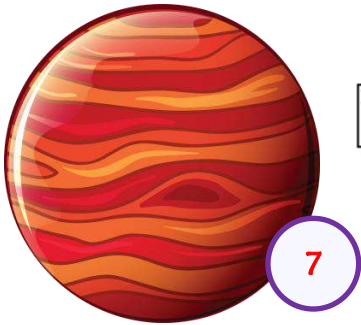

7

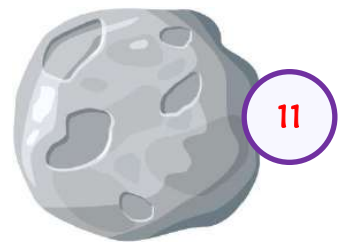
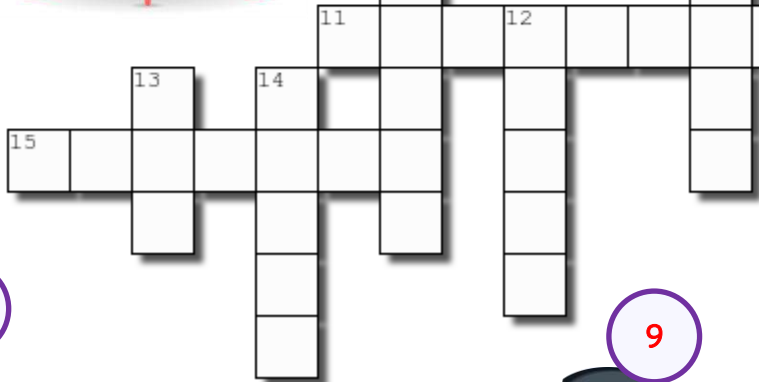

11



15



12



9

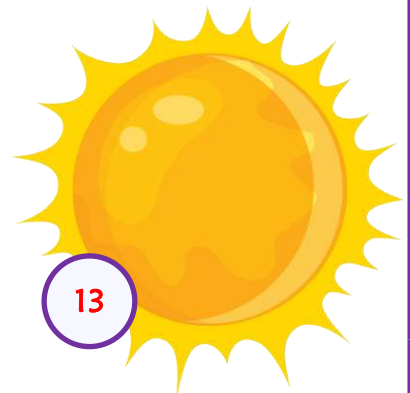

13

ANSWER KEY

Across

1. Moon
3. telescope
6. observatory
7. planet
8. rocket
9. astronaut
11. asteroid
15. shuttle

Down

1. meteorite
2. ufo
4. satellite
5. solar system
10. alien
12. Earth
13. Sun
14. stars

SPACE MISSING LETTERS IN WORDS

Write the missing letters in the boxes to complete the space vocabulary



pl_n_t

_bs_rv_t_ry

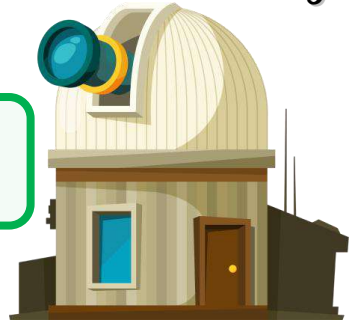

t_l_sc_p_



st_rs



_str_n__t

M__n

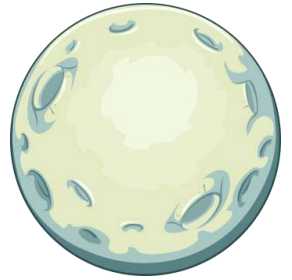

S_n

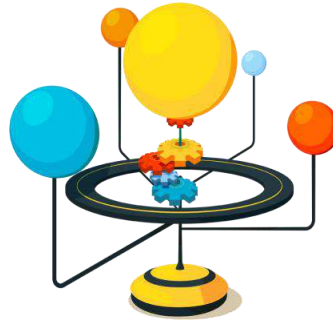

s_l_r syst_m



f

s_t_ll_t_

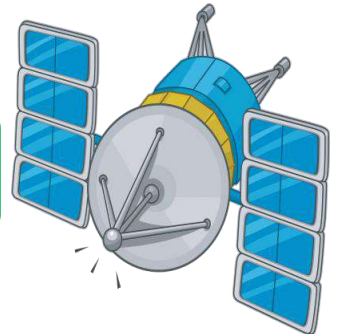

r_ck_t



m_t__r_t_



sh_ttl_

_st_r__d



_l__n

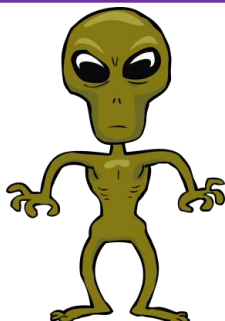

__rth

SPACE MISSING LETTERS IN WORDS ANSWER KEY

Write the missing letters in the boxes to complete the space vocabulary



planet

observatory



telescope



stars



astronavt

Moon

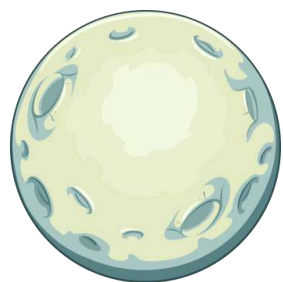

Sun

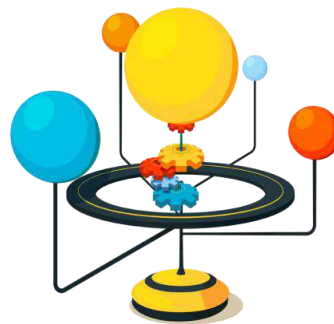

solar system



ufo

satellite

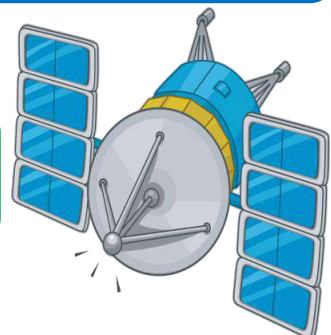

rocket



meteorite



shutte

asteroid



alien

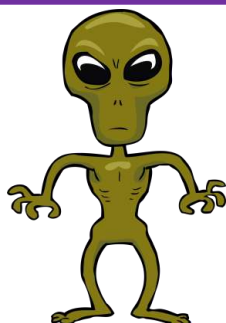

Earth

SPACE UNSCRAMBLE THE WORDS

Unscramble the space vocabulary and number the pictures

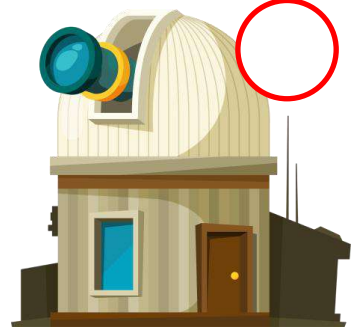
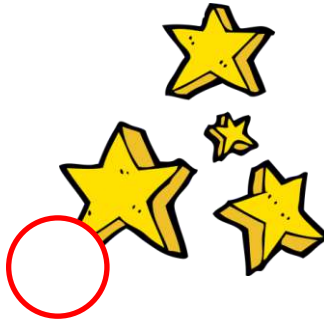
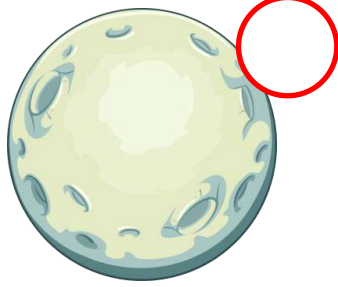
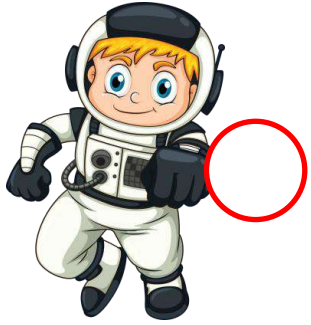

1. tteluhs _____
2. toeleescp _____
3. naetpl _____
4. ieemrtteo _____
5. nsu _____
6. anrsttoa _____
7. rosaited _____
8. uof _____
9. heart _____
10. aosrl myesst _____
11. btroavesory _____
12. srsta _____
13. ecrtok _____
14. ilean _____
15. Itaseitle _____
16. nomo _____

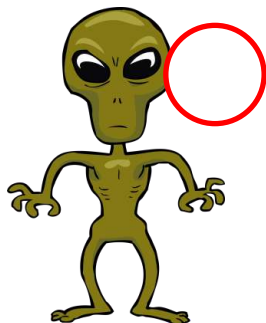
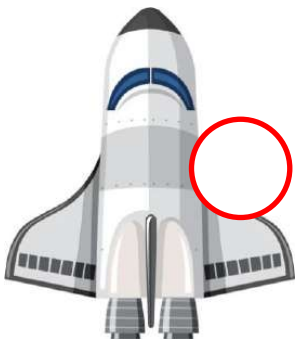
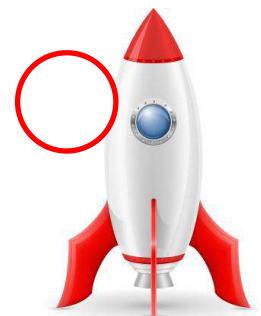
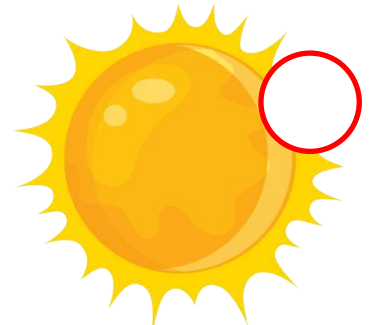
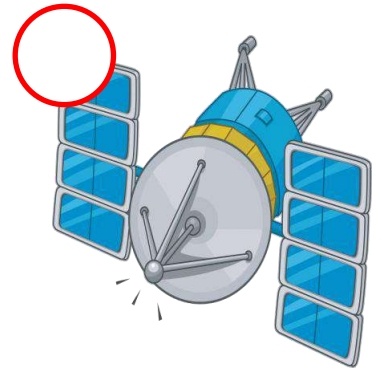
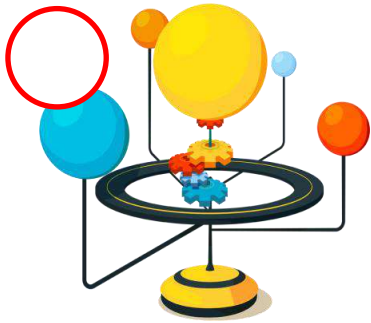
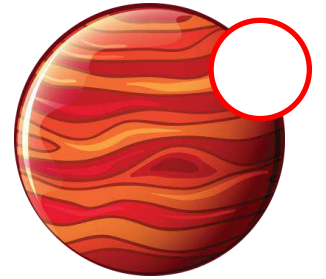

SPACE UNSCRAMBLE THE WORDS ANSWER KEY

Unscramble the space vocabulary and number the pictures

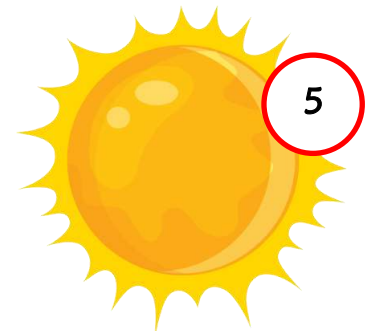
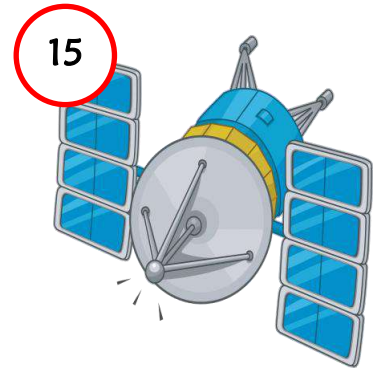
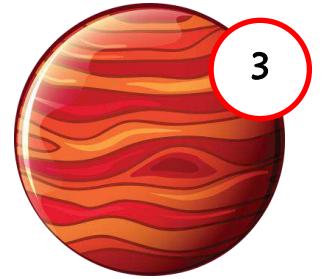
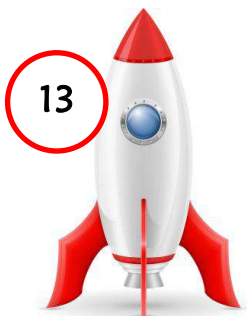
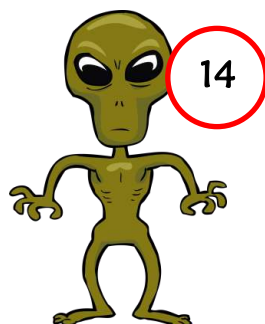
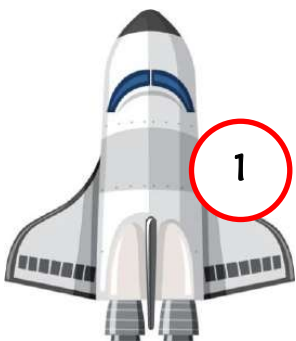
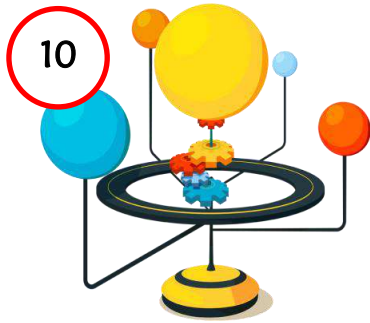
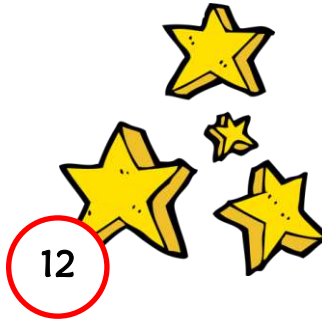

- | | |
|------------------|--------------|
| 1. tteluhs | shuttle |
| 2. toeleescp | telescope |
| 3. naetpl | planet |
| 4. iemrtteo | meteorite |
| 5. nsu | Sun |
| 6. anrsttoa | astronaut |
| 7. rosaited | asteroid |
| 8. uof | ufo |
| 9. heart | Earth |
| 10. aosrl myesst | solar system |
| 11. btroavesory | observatory |
| 12. srsta | stars |
| 13. ecrtok | rocket |
| 14. ilean | alien |
| 15. ltaseitle | satellite |
| 16. nomo | Moon |

SPACE MULTIPLE CHOICE TEST

Look at the pictures, choose and circle the correct option.

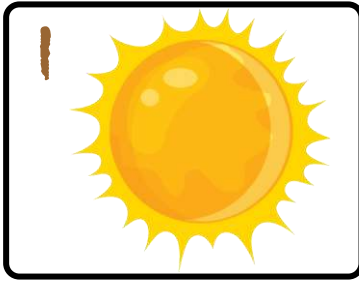

- a) rocket
- b) alien
- c) asteroid
- d) Sun



- a) solar system
- b) telescope
- c) Earth
- d) astronaut

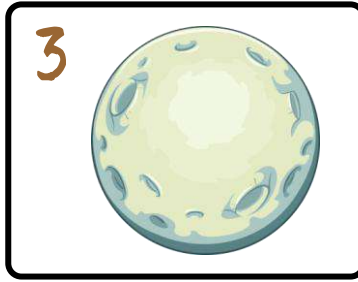

- a) observatory
- b) shuttle
- c) stars
- d) Moon

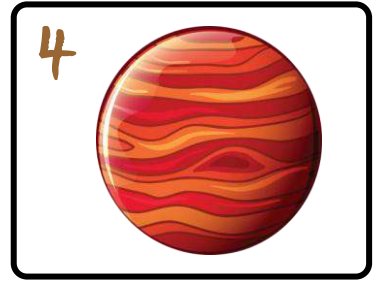

- a) meteorite
- b) planet
- c) ufo
- d) satellite



- a) stars
- b) Moon
- c) astronaut
- d) observatory



- a) asteroid
- b) rocket
- c) ufo
- d) planet



- a) Earth
- b) meteorite
- c) satellite
- d) alien



- a) telescope
- b) Sun
- c) solar system
- d) shuttle

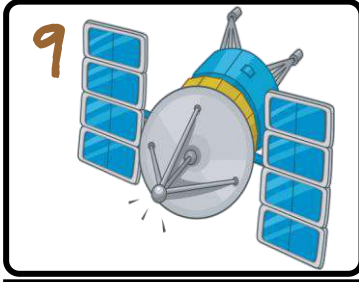

- a) solar system
- b) satellite
- c) telescope
- d) Earth



- a) shuttle
- b) observatory
- c) Sun
- d) stars

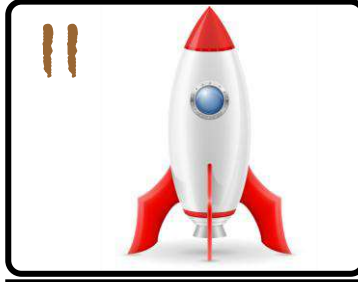

- a) planet
- b) ufo
- c) asteroid
- d) rocket



- a) meteorite
- b) astronaut
- c) alien
- d) Moon



- a) asteroid
- b) shuttle
- c) ufo
- d) Sun

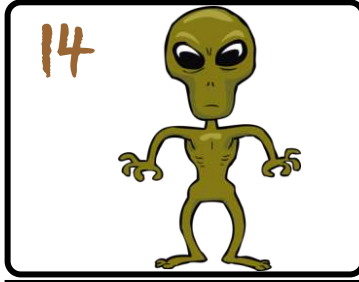

- a) alien
- b) Moon
- c) astronaut
- d) solar system



- a) satellite
- b) Earth
- c) telescope
- d) meteorite



- a) stars
- b) planet
- c) rocket
- d) observatory

SPACE MULTIPLE CHOICE TESTS ANSWER KEY

TEST 1

- 1) d
- 2) c
- 3) d
- 4) b
- 5) a
- 6) a
- 7) b
- 8) c
- 9) b
- 10) a
- 11) d
- 12) b
- 13) c
- 14) a
- 15) c
- 16) d

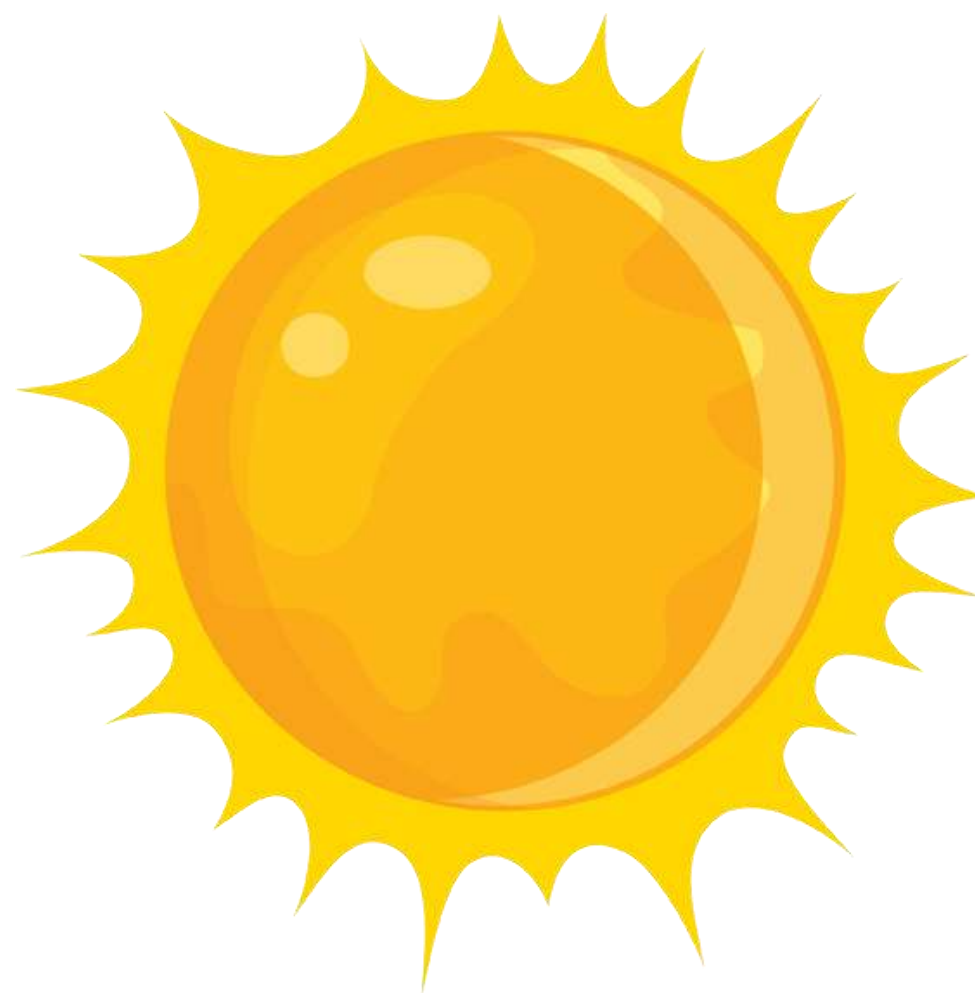

Sun



Earth

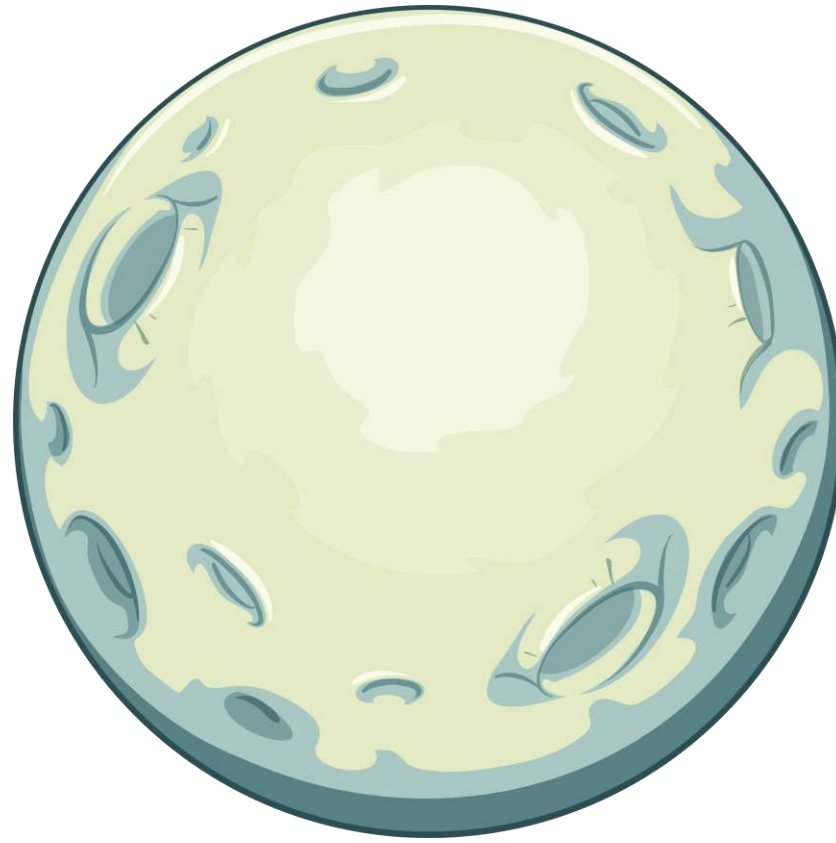

Moon



planet

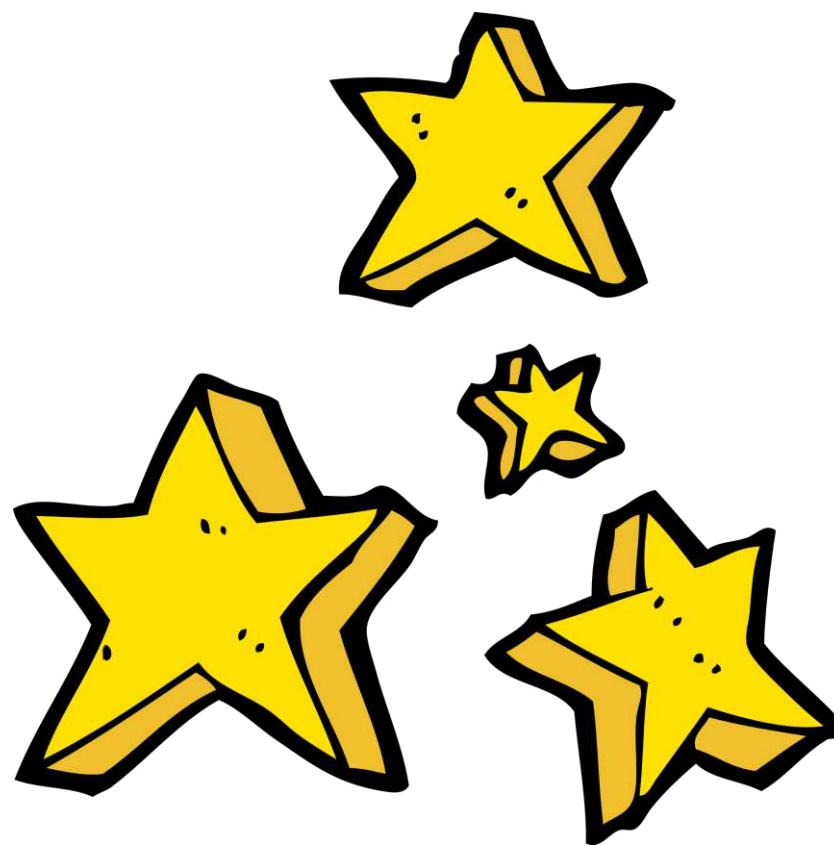

stars

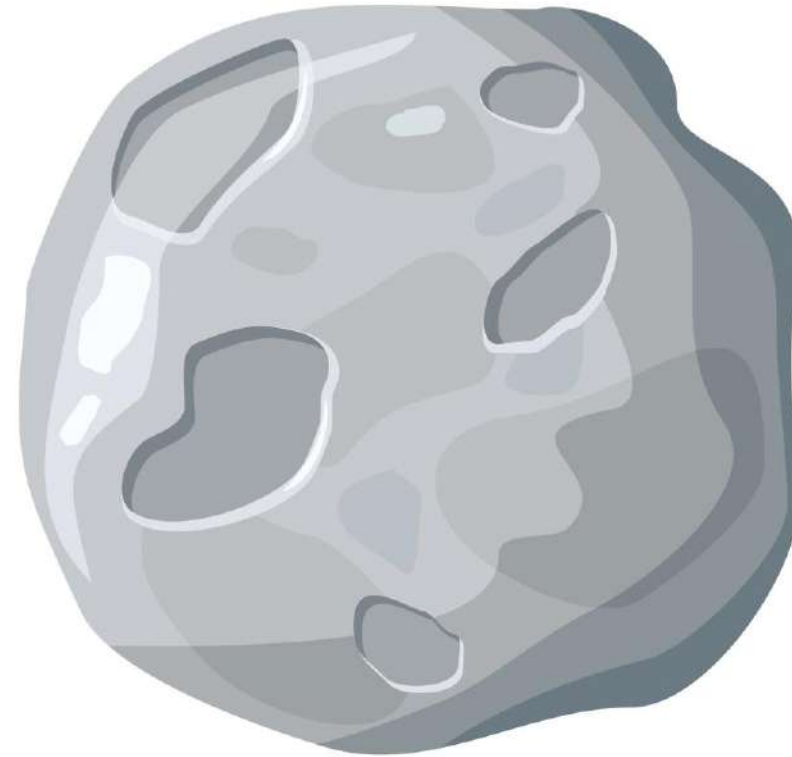

asteroid



meteorite

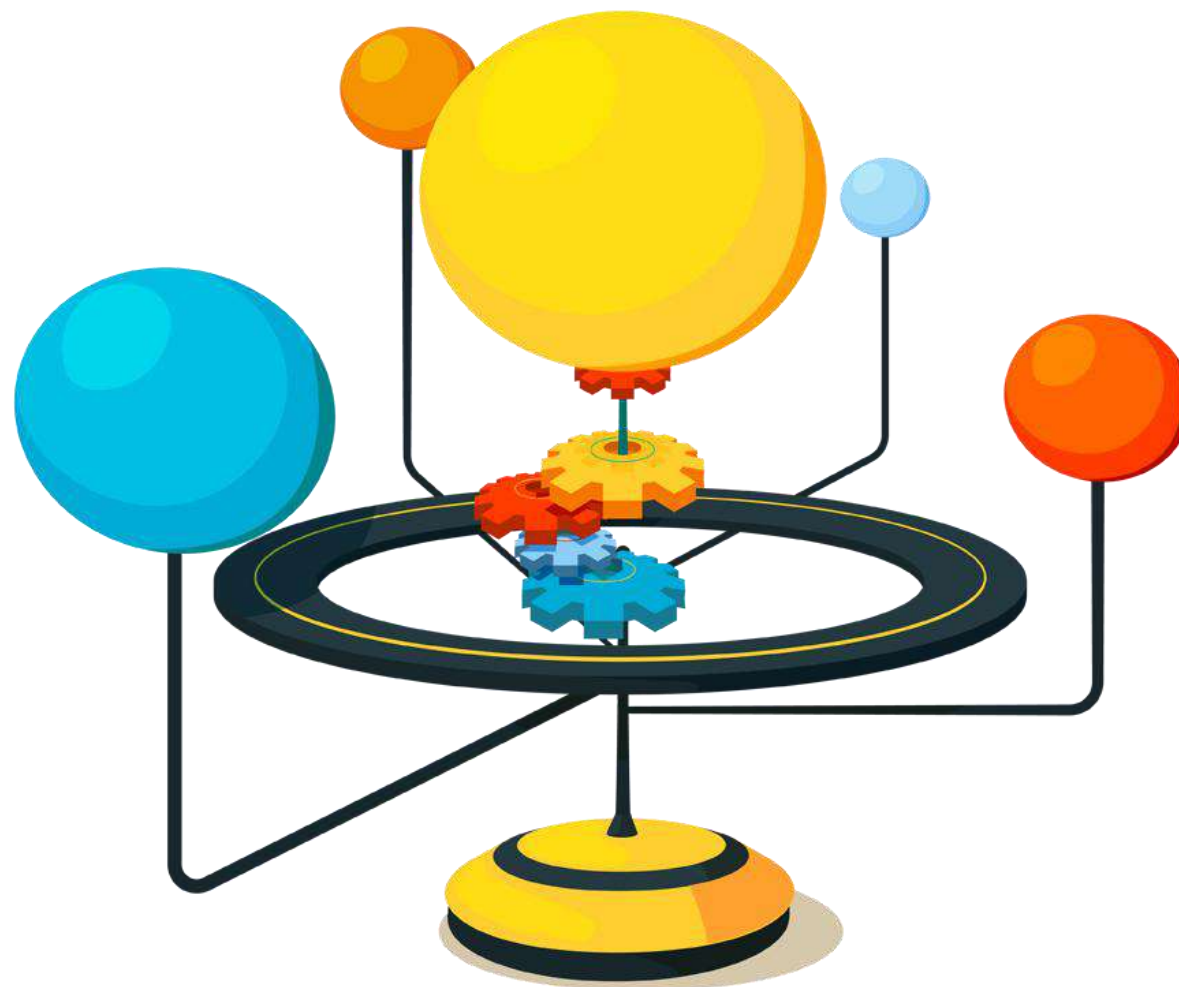

solar system

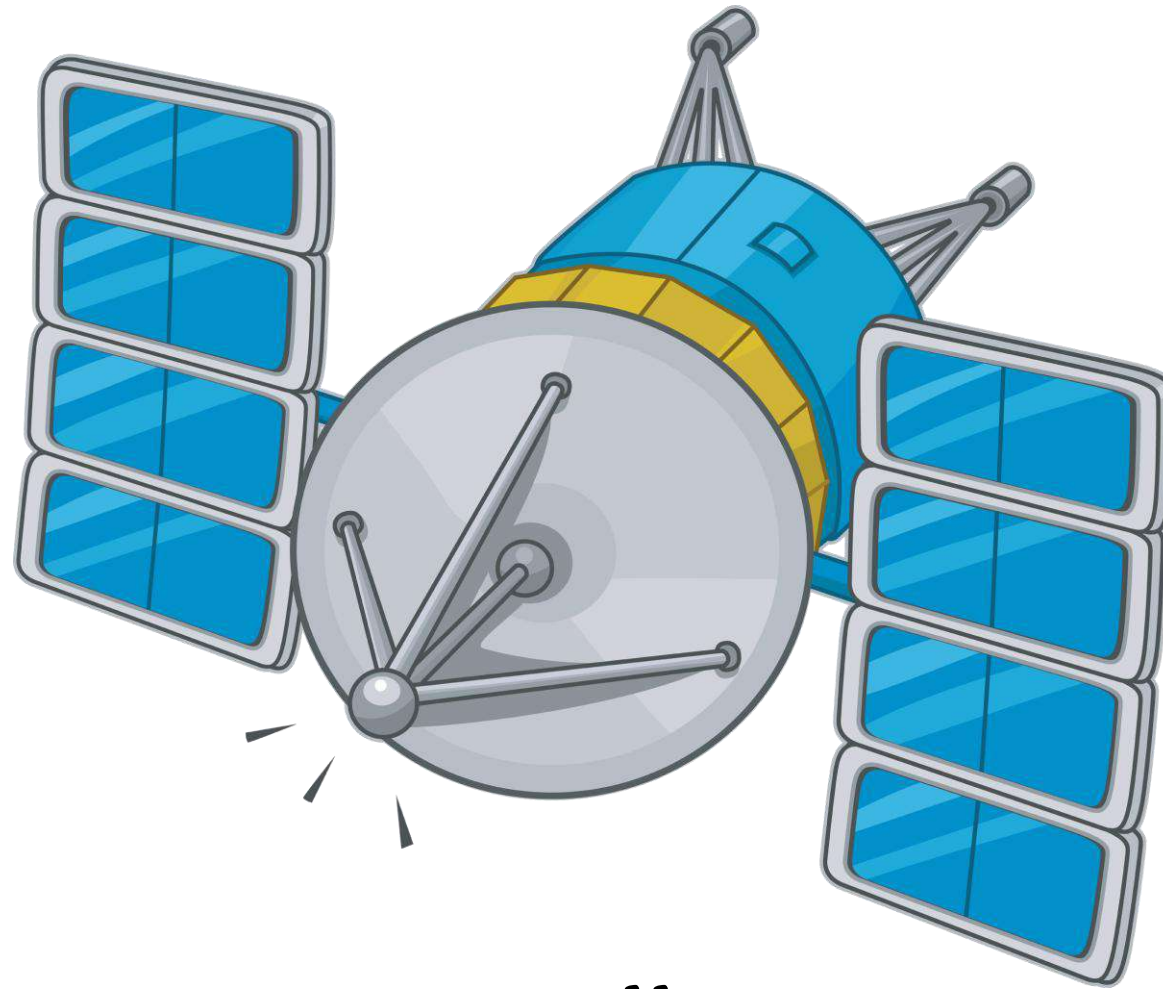

satellite

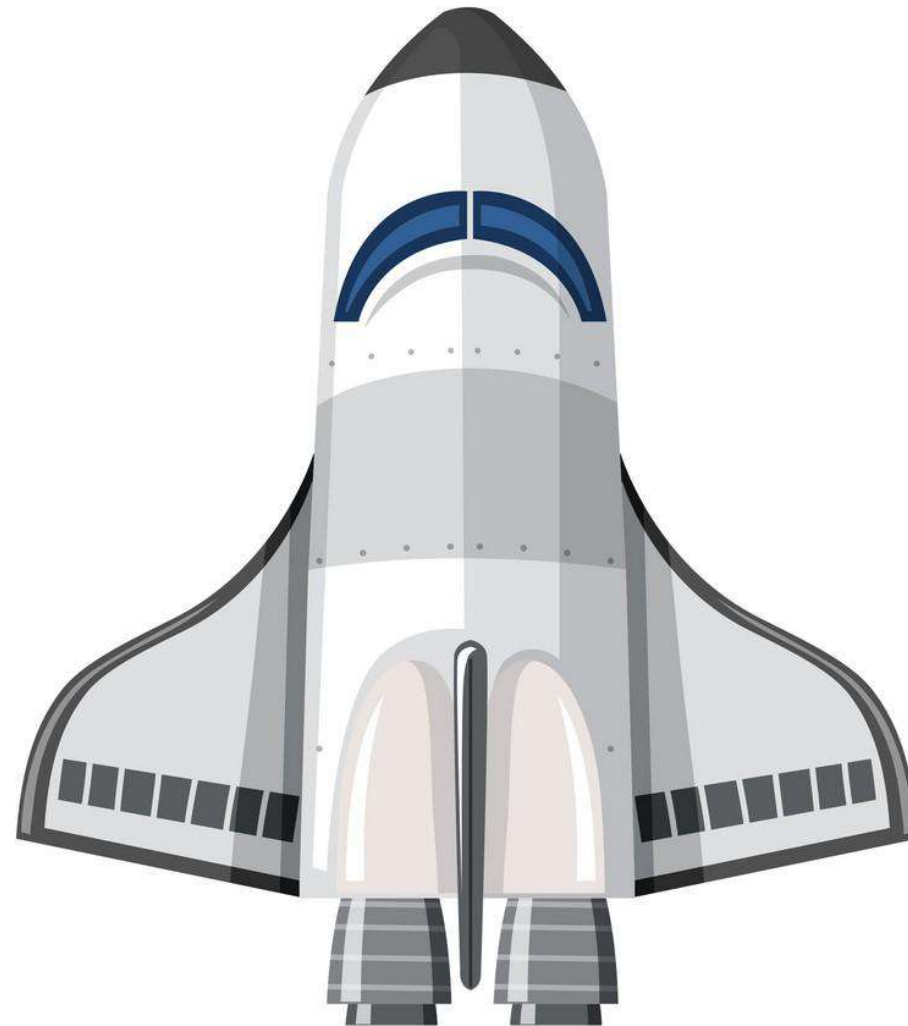

shuttle



rocket



astronaut



ufo

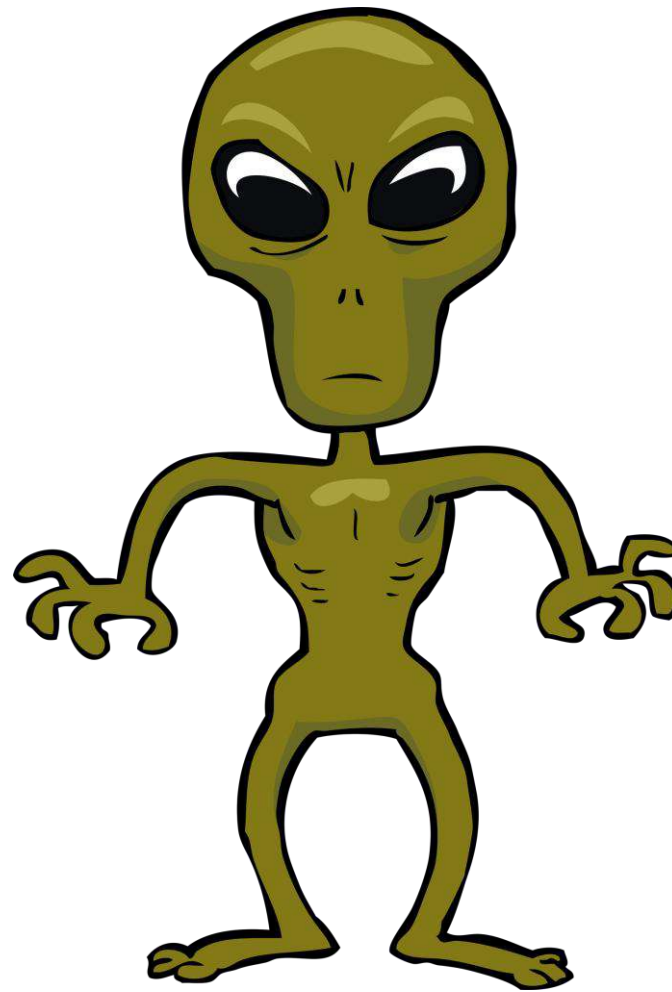

alien



telescope



observatory





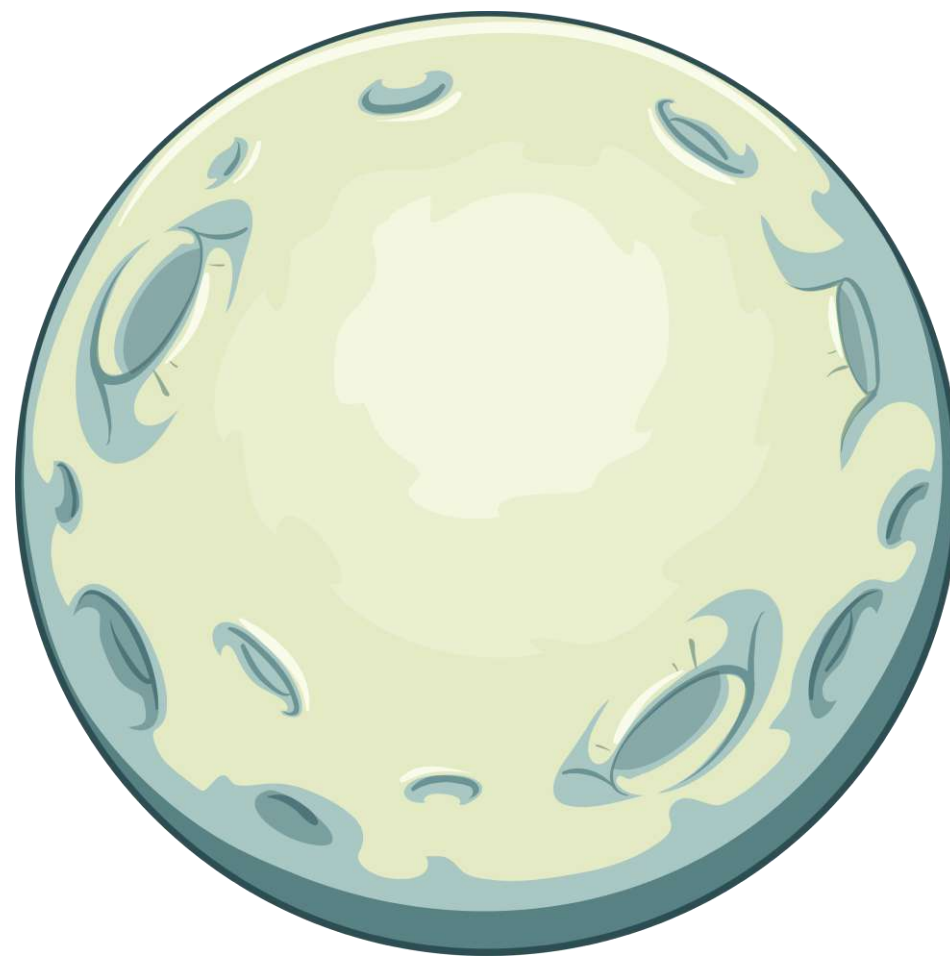



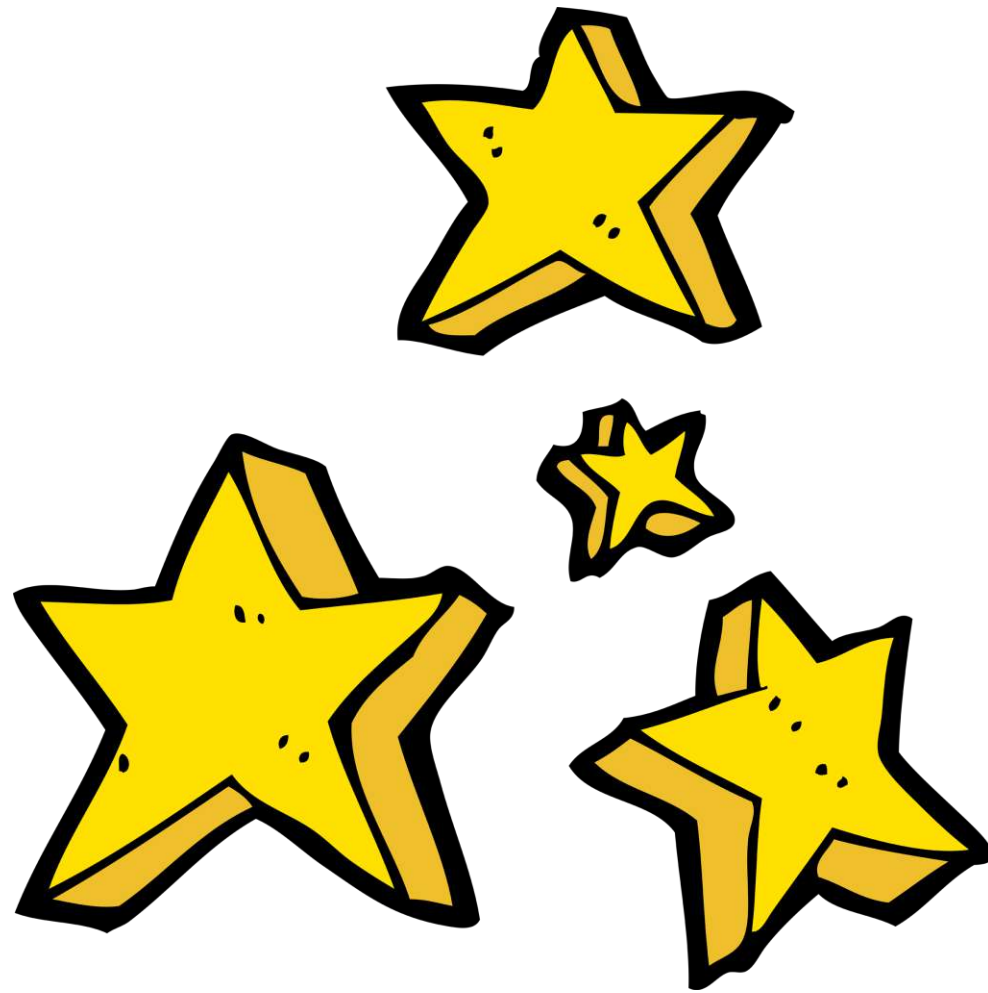

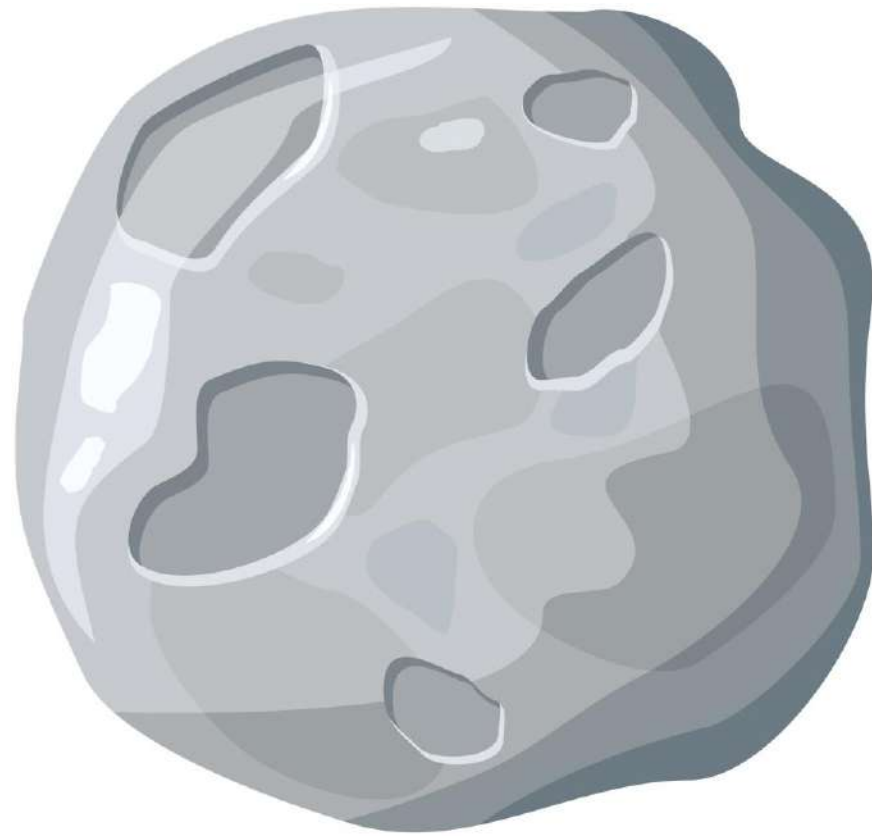



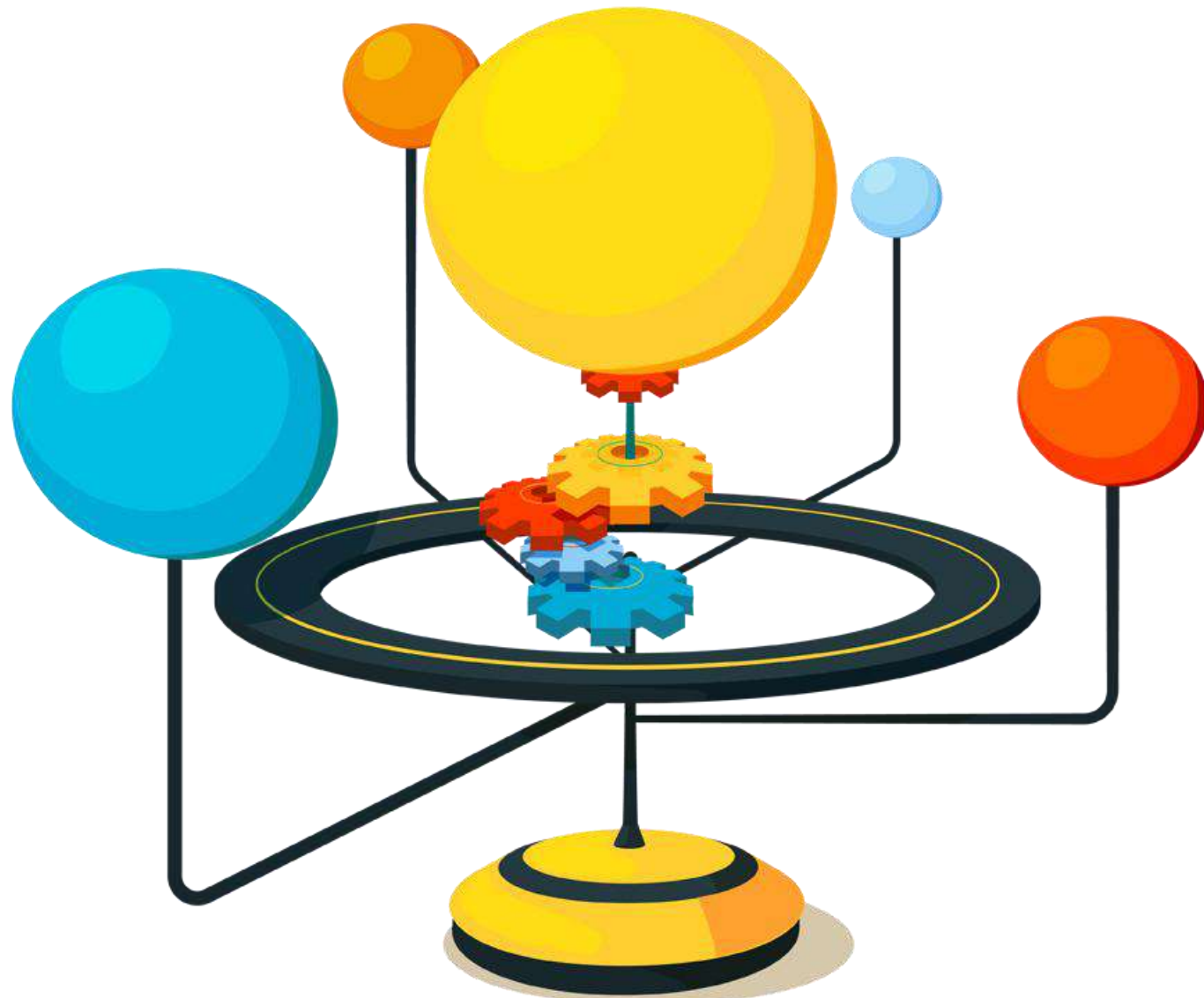

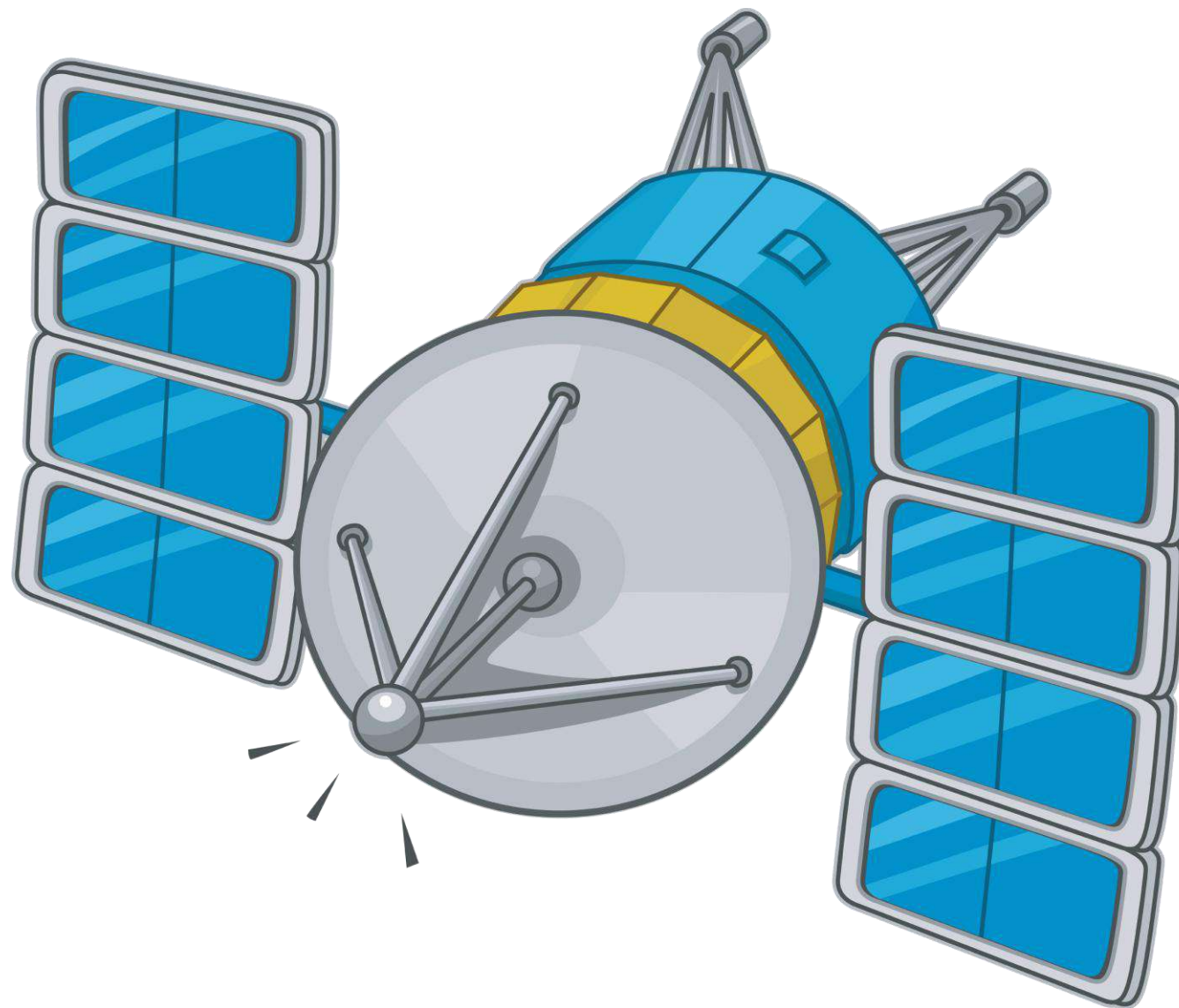

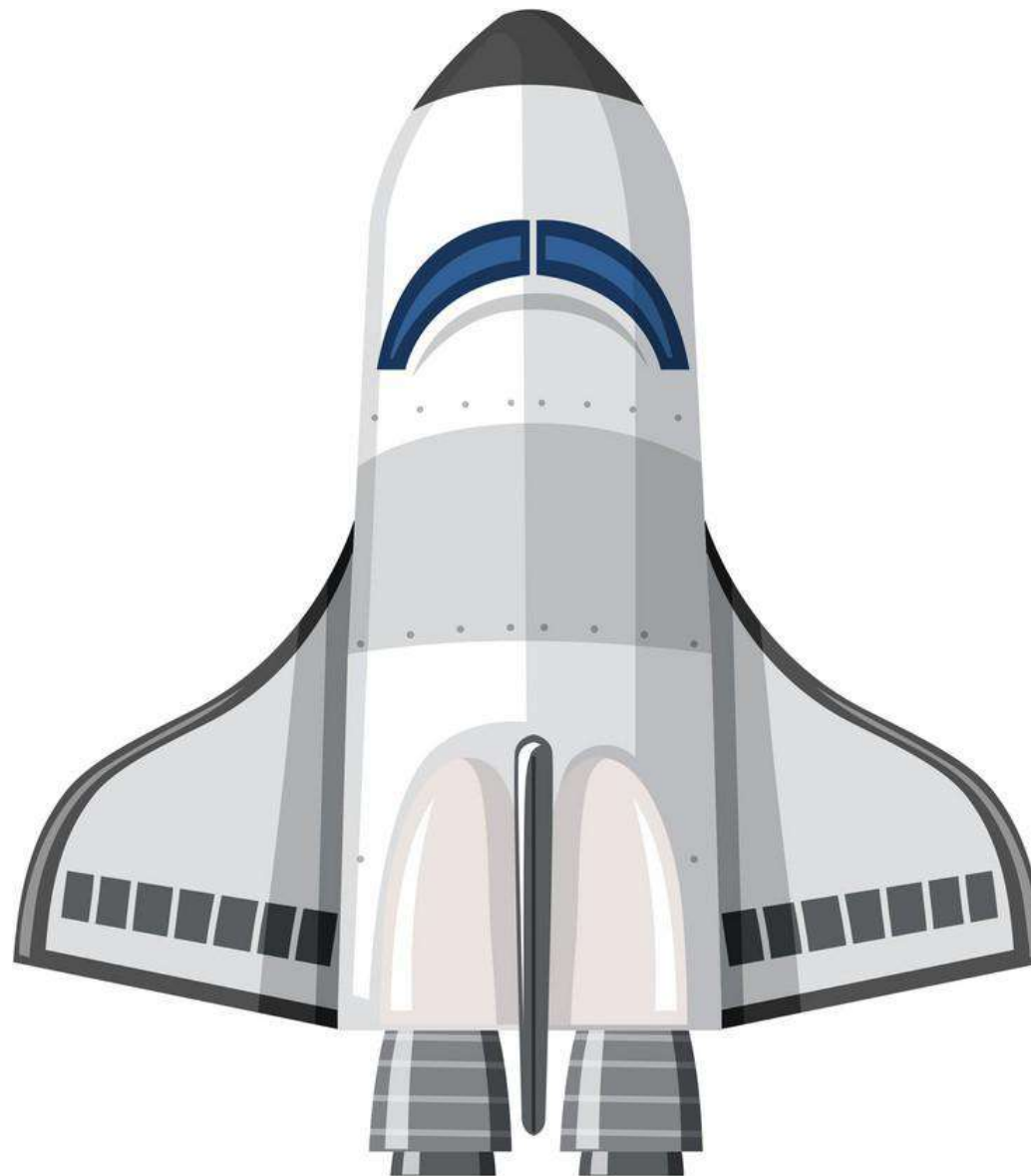







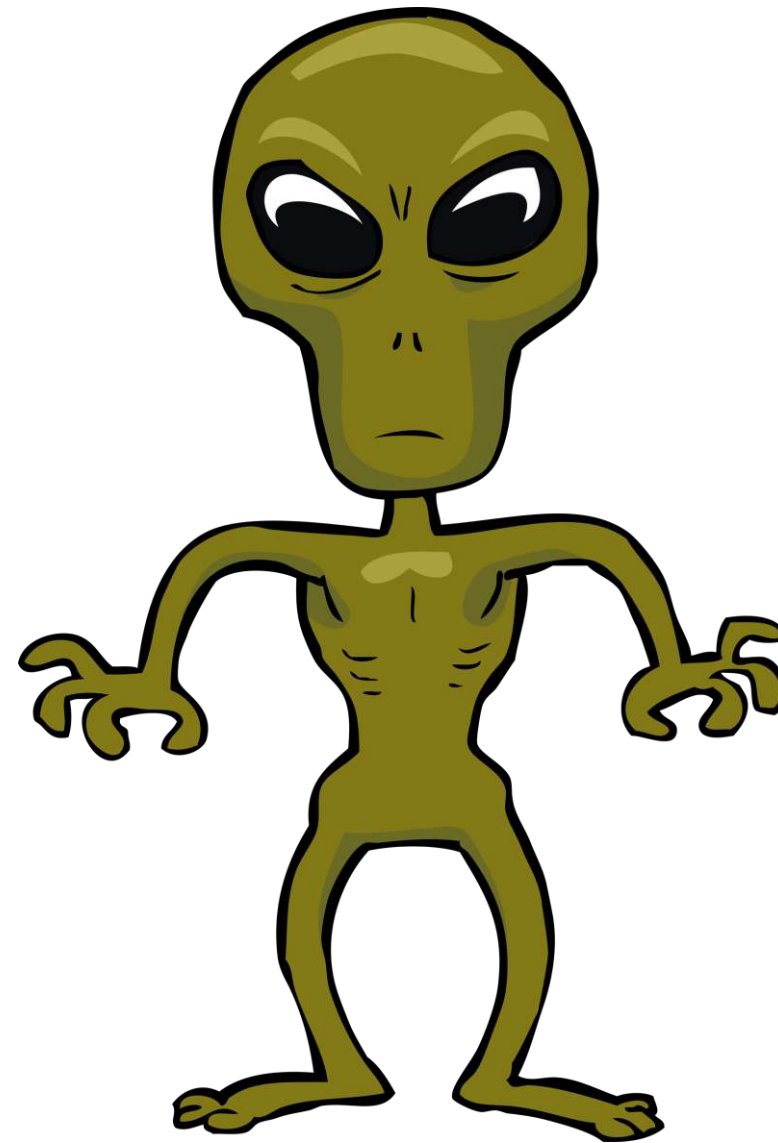





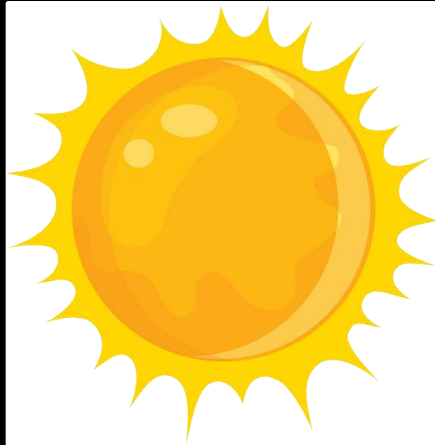

Sun

Copyright © 07/02/2021 englishsheets.com. All rights reserved.



Earth

Copyright © 07/02/2021 englishsheets.com. All rights reserved.



Moon

Copyright © 07/02/2021 englishsheets.com. All rights reserved.



planet

Copyright © 07/02/2021 englishsheets.com. All rights reserved.

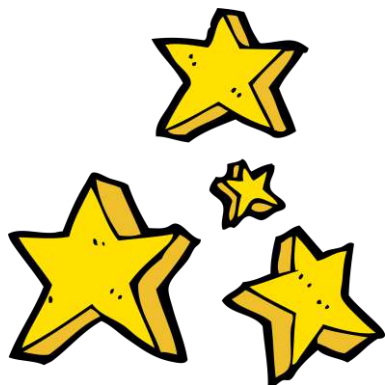

stars

Copyright © 07/02/2021 englishsheets.com. All rights reserved.



asteroid

Copyright © 07/02/2021 englishsheets.com. All rights reserved.



meteorite

Copyright © 07/02/2021 englishsheets.com. All rights reserved.

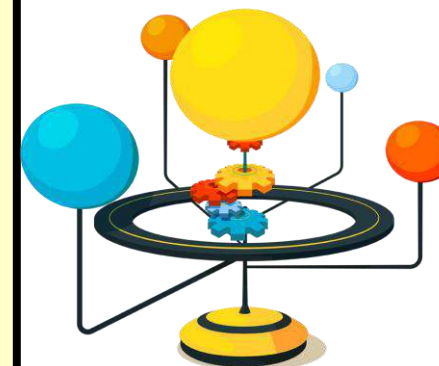

solar system

Copyright © 07/02/2021 englishsheets.com. All rights reserved.

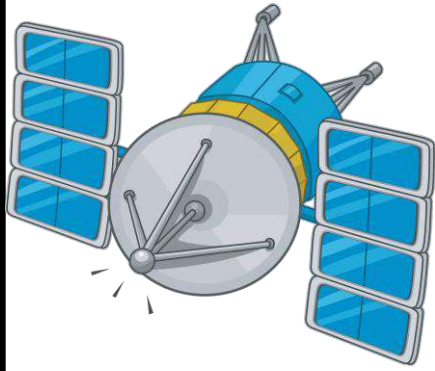

satellite

Copyright © 07/02/2021 englishsheets.com. All rights reserved.

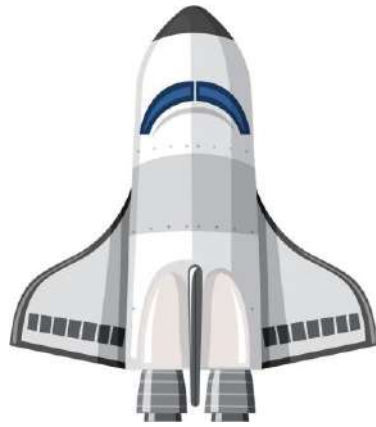

shuttle

Copyright © 07/02/2021 englishsheets.com. All rights reserved.



rocket

Copyright © 07/02/2021 englishsheets.com. All rights reserved.



astronaut

Copyright © 07/02/2021 englishsheets.com. All rights reserved.



ufo

Copyright © 07/02/2021 englishsheets.com. All rights reserved.

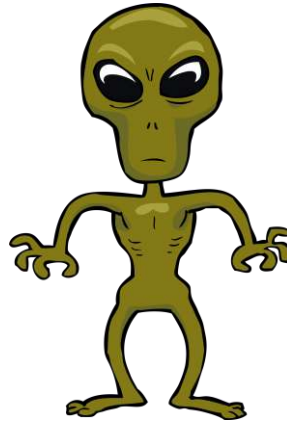

alien

Copyright © 07/02/2021 englishsheets.com. All rights reserved.



telescope

Copyright © 07/02/2021 englishsheets.com. All rights reserved.



observatory

Copyright © 07/02/2021 englishsheets.com. All rights reserved.

SPACE FIDGET SPINNER GAME

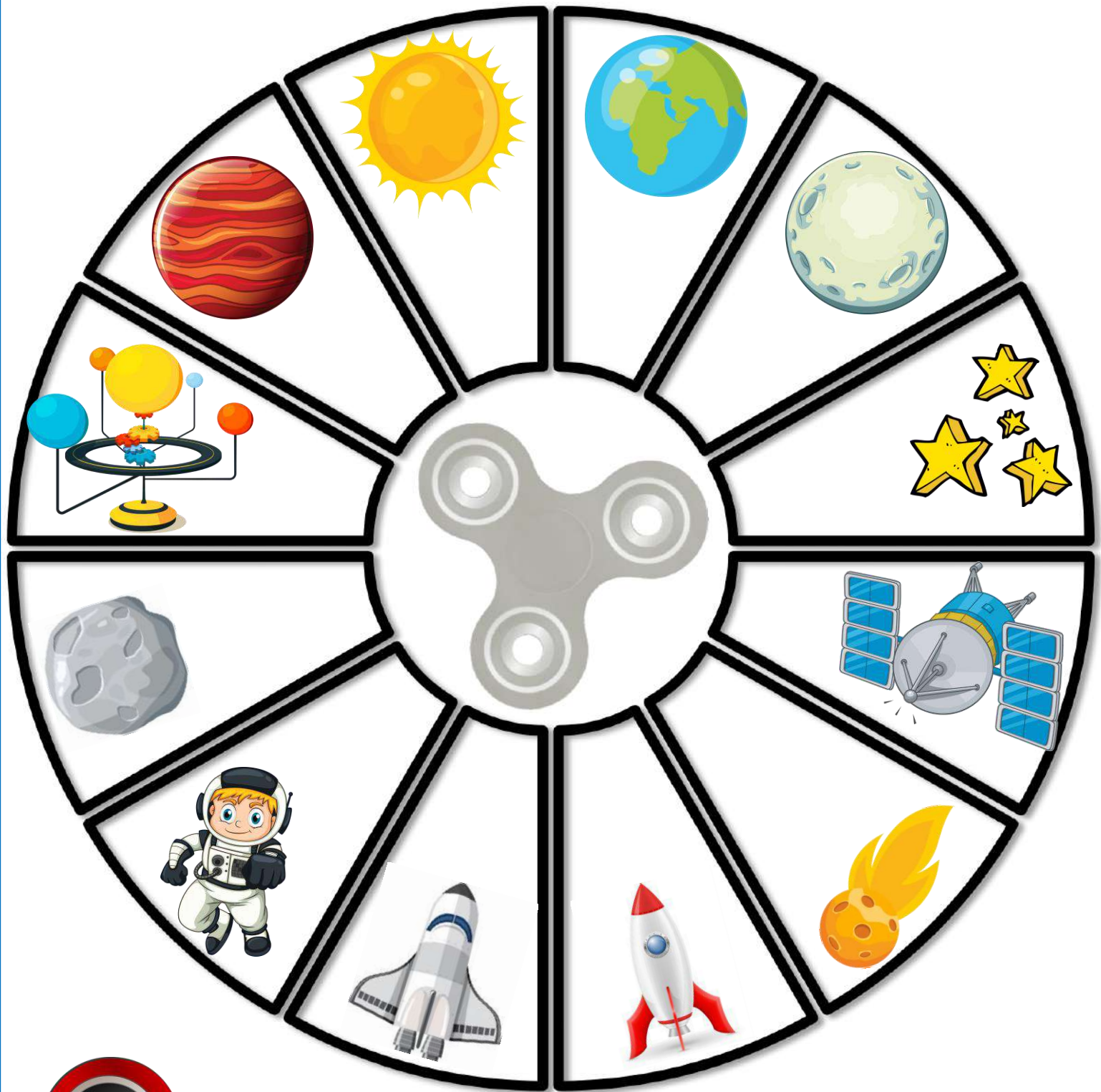

- Cut a small arrow from paper or craft foam and stick it onto the fidget spinner as your pointer.
- Place the fidget spinner in the middle of the vocabulary circle.
- Spin it and say the word quickly!

SPACE FIDGET SPINNER GAME

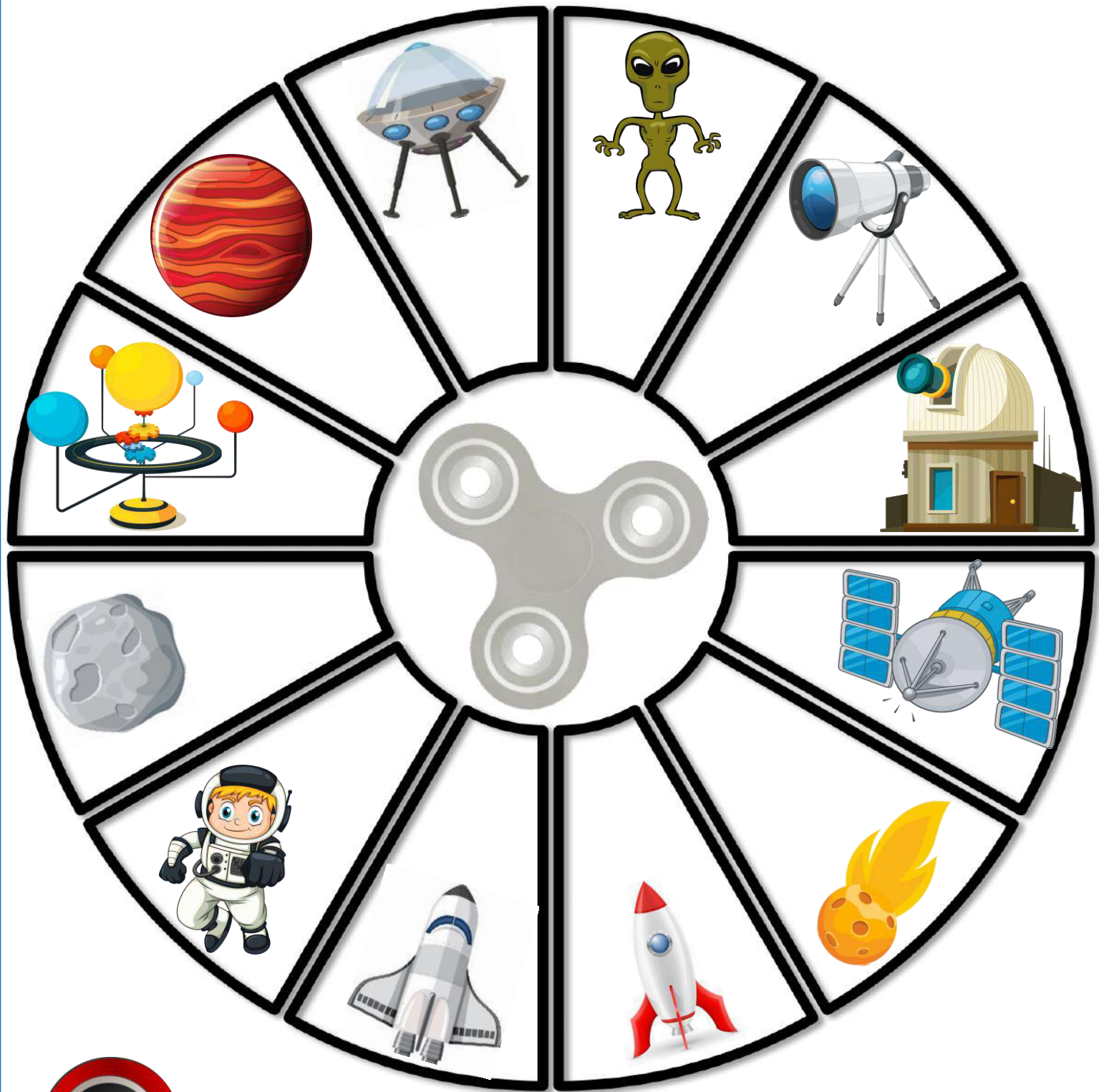

- Cut a small arrow from paper or craft foam and stick it onto the fidget spinner as your pointer.
- Place the fidget spinner in the middle of the vocabulary circle.
- Spin it and say the word quickly!



Sun



Earth



Moon

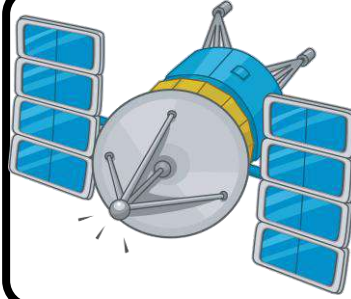

planet



stars



asteroid



meteorite



solar system



satellite



shuttle



rocket

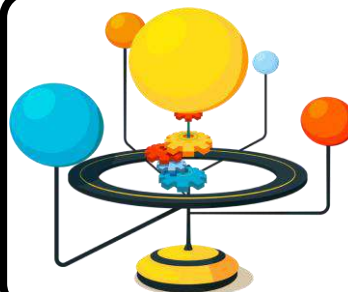

astronaut



ufo



alien

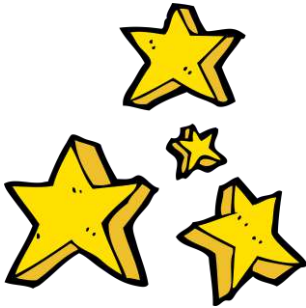

telescope



observatory