

INDEFINITE PRONOUNS

SOMEBODY, ANYBODY, NOBODY,
EVERYBODY, SOMEWHERE, ANYWHERE
NOWHERE, EVERYWHERE, SOMETHING
ANYTHING, NOTHING, EVERYTHING

EXPLANATION

An indefinite pronoun is a pronoun that refers to one or more unspecified beings, objects, or places.

FOR PEOPLE

We use;

- ✓ **somebody**
- ✓ **anybody**
- ✓ **nobody**
- ✓ **everybody**

FOR PLACES

We use;

- ✓ **somewhere**
- ✓ **anywhere**
- ✓ **nowhere**
- ✓ **everywhere**

FOR THINGS

We use;

- ✓ **something**
- ✓ **anything**
- ✓ **nothing**
- ✓ **everything**

FILL IN THE BLANKS WITH SOMEBODY-ANYBODY-NOBODY-EVERYBODY

1. Mark opened the door and entered the house. He shouted "Hello" , but there was no answer. There was in the house. was at the party.
2. Last night broke into Johnsons flat and stole the laptop. It was an easy job for the thief because there was in the house.
3. When the earthquake happened , in the apartment building went out immediately. Luckily , was injured.
4. There wasn't in the library because it was very early in the morning.
5. Our English teacher said "Can help me? I can't carry these boxes."
6. on the beach was terrified because there was a big shark near the shore. shouted "Get out of the sea. It seems hungry."
7. I think can solve this Maths problem. It looks impossible.

FILL IN THE BLANKS WITH SOMEWHERE-ANYWHERE-NOWHERE-EVERYWHERE

1. She looked at school , but she couldn't see her best friend, Sarah.
2. Last weekend my family and I went on a picnic. The scene was wonderful. There were flowers and trees
3. "Mom, where is my favourite t-shirt? I put it and now I can't find it. I checked in my room but I couldn't see it"
4. in Turkey is worth seeing. It's really a perfect country to visit. It has some nice beaches that you can't come across in the world.
5. I want to go for the summer holiday, but I haven't decided yet.
6. else in the world makes me as happy as my hometown. I love it.
7. We saw in Bodrum. How about going to different this time?
9. in the world is drier than Atacama Desert. In fact it's the driest place on earth. The average rainfall is 1 millilitre per square a year.

FILL IN THE BLANKS WITH SOMETHING-ANYTHING-NOTHING-EVERYTHING

1. The weather is very hot and Lucy wants to drink cold.
2. in this clothes shop is quite reasonable. That's why a lot of people go there for shopping.
3. I searched all my books in my bookcase but I couldn't find about environmental problems.
4. There was in our refrigerator after a three month holiday.
5. "Do you want from the supermarket. I'm going shopping."
6. When my father asked me "How is school?" I said "..... is fine".
7. A: Did you do about the project last night? B: No, I did
8. I'm an optimistic person so I believe in my life will be perfect.
9. A: Did you hear about the accident. B: No, I heard

CHOOSE THE CORRECT OPTION

1. I didn't eat at the restaurant. I wasn't hungry.
a) something b) anything c) everything
2. We are looking for to help us with our homework.
a) somebody b) anybody c) everybody
3. Jack wants to watch funny on TV.
a) something b) anything c) everything
4. There's interesting on TV today so let's go to the cinema.
a) something b) anything c) nothing
5. Have you seen my wallet ?
a) nowhere b) anywhere c) everywhere
6. Let's go and drink coke?
a) everywhere b) anywhere c) somewhere
7. stole my car. I'm very sad.
a) somebody b) anybody c) everybody
8. I knocked the door for a long time but opened it.
a) somebody b) anybody c) nobody
9. I know in this apartment building. You can ask me the names.
a) somebody b) anybody c) everybody

REFLEXIVE PRONOUNS EXERCISES

Fill in the blanks with " myself , himself , herself , itself , yourself , ourselves , yourselves , themselves " to complete the sentences below

1. Charlotte looked at _____ in the golden mirror and said "I am still pretty."
2. Why don't you make _____ a big hamburger and a glass of lemonade?
3. Harrison found _____ a nice black suit to wear at the wedding on next Tuesday.
4. The children will have to look after _____ because their parents won't be at home this evening.
5. We only blame _____ for the big fire in the forest. We forgot to extinguish the camp fire before we leave.
6. My cat hurt _____ when it suddenly jumped out of the kitchen window.
7. I think I will buy _____ a nice expensive smartphone.
8. Ladies and gentlemen! This is open buffet so you can help _____ .
9. Some animals clean _____ with their tongues.
10. Mrs. Saunders cut _____ while she was chopping onions for the salad.
11. Samuel tried to defend _____ when two men attacked him suddenly.
12. You should buy _____ a dictionary. I can't lend you mine as I need it.
13. I telephoned the plumber several time but I couldn't reach him. Finally I decided to repair the tap _____ .
14. Hi kids! If you want to be successful students , you should do your homework _____ .
15. When the dog saw _____ on the mirror , it started barking wildly.
16. Alice and I painted the house _____ because we didn't have enough money to hire a painter.

REFLEXIVE PRONOUNS EXERCISES ANSWER KEY

Fill in the blanks with " myself , himself , herself , itself , yourself , ourselves , yourselves , themselves " to complete the sentences below

1. Charlotte looked at **herself** in the golden mirror and said "I am still pretty."
2. Why don't you make **yourself** a big hamburger and a glass of lemonade?
3. Harrison found **himself** a nice black suit to wear at the wedding on next Tuesday.
4. The children will have to look after **themselves** because their parents won't be at home this evening.
5. We only blame **ourselves** for the big fire in the forest. We forgot to extinguish the camp fire before we leave.
6. My cat hurt **itself** when it suddenly jumped out of the kitchen window.
7. I think I will buy **myself** a nice expensive smartphone.
8. Ladies and gentlemen! This is open buffet so you can help **yourselves** .
9. Some animals clean **themselves** with their tongues.
10. Mrs. Saunders cut **herself** while she was chopping onions for the salad.
11. Samuel tried to defend **himself** when two men attacked him suddenly.
12. You should buy **yourself** a dictionary. I can't lend you mine as I need it.
13. I telephoned the plumber several time but I couldn't reach him. Finally I decided to repair the tap **myself** .
14. Hi kids! If you want to be successful students , you should do your homework **yourselves** .
15. When the dog saw **itself** on the mirror , it started barking wildly.
16. Alice and I painted the house **ourselves** because we didn't have enough money to hire a painter.

!+?=(...) PUNCTUATION MARKS !+?=(...)

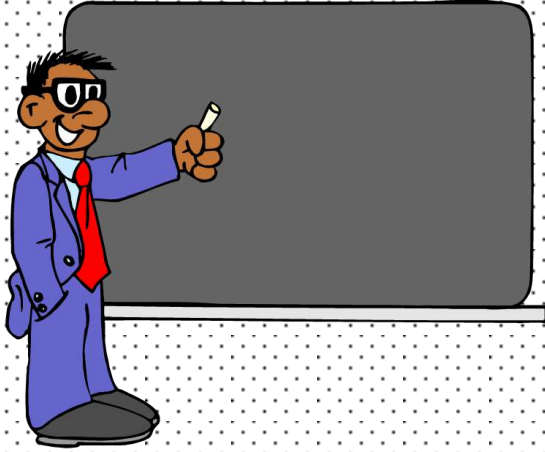

LOOK AT THE SENTENCES BELOW AND PUT THE PUNCTUATION MARKS INTO CORRECT PLACES

1. Do you really want to buy Marys house for £35000
Thats too much
2. If you need any help about the project please call me
3. Look Mr Thompsons driving a Ferrari Thats incredible
4. In the film the actor says will you marry me my dear
princess The girl refuses his proposal
5. Those who are against wars are pacifists those who are
for wars are fools
6. Can you see the on off button on the radio
7. Mustafa Kemal Atatürk the founder of the Turkish
republic died on 10th November 1938
8. Remember Teachers are the construction workers of the
future
9. When I go to the supermarket Ill buy tomatoes potatoes
and onions
- 10.The teacher said Practice makes perfect in Science
lesson yesterday
- 11.Lets not forget this point Science is the most reliable
guide in life
- 12.Johns parents are coming to see his gradution ceremony
this weekend
- 13.Oh god Ive lost my wallet It was in my pocket when I
left home Where did I lose it I have no idea
- 14.When we were at the zoo we saw elephants giraffes
tigers lions and crocodiles
- 15.There are four main language skills reading writing
listening and speaking
- 16.Always keep in mind Early bird catches the worm
- 17.What on earth are you doing Stop Dont touch that
painting It is still wet Ive just painted it
- 18.I think there is a problem with the start stop mechanism
of my car
- 19.Did you read Emilys latest book Love and Pain
- 20.Wow What a nice dress You should really buy it

COLON = :

PERIOD = .

COMMA = ,

QUOTATION = "

SEMICOLON = ;

APOSTROPHE = '

QUESTION MARK = ?

SLASH = /

EXCLAMATION POINT = !

PARENTHESES = ()

!+?=(...) PUNCTUATION MARKS !+?=(...)

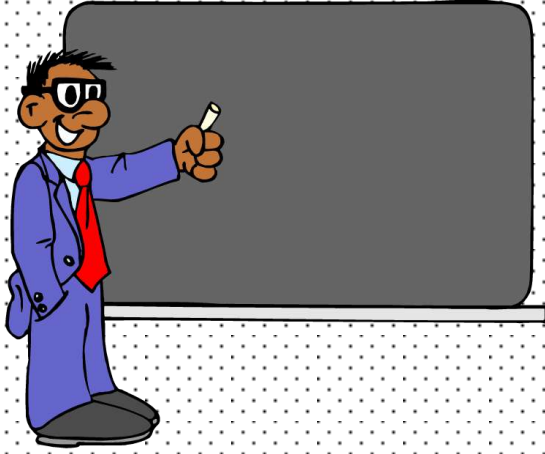

LOOK AT THE SENTENCES BELOW AND PUT THE PUNCTUATION MARKS INTO CORRECT PLACES

21. Do you really want to buy Mary's house for £35000?
That's too much.
22. If you need any help about the project , please call me
23. Look ! Mr Thompson's driving a Ferrari. That's incredible!
24. In the film , the actor says "Will you marry me , my dear princess ? " The girl refuses his proposal.
25. Those who are against wars are pacifists ; those who are for wars are fools
26. Can you see the on / off button on the radio ?
27. Mustafa Kemal Atatürk , the founder of the Turkish republic , died on 10th November 1938.
28. Remember: "Teachers are the construction workers of the future"
29. When I go to the supermarket , I'll buy tomatoes potatoes and onions.
30. The teacher said: "Practice makes perfect." in Science lesson yesterday
31. Let's not forget this point: "Science is the most reliable guide in life."
32. John's parents are coming to see his graduation ceremony this weekend.
33. Oh god! I've lost my wallet. It was in my pocket when I left home. Where did I lose it? I have no idea.
34. When we were at the zoo , we saw elephants, giraffes , tigers, lions and crocodiles.
35. There are four main language skills; reading, writing, listening and speaking.
36. Always keep in mind: "Early bird catches the worm"
37. What on earth are you doing! Stop! Don't touch that painting! It is still wet. I've just painted it.
38. I think there is a problem with the start / stop mechanism of my car.
39. Did you read Emily's latest book "Love and Pain" ?
40. Wow! What a nice dress! You should really buy it.

COLON = :

PERIOD = .

COMMA = ,

QUOTATION = "

SEMICOLON = ;

APOSTROPHE = '

QUESTION MARK = ?

SLASH = /

EXCLAMATION POINT = !

PARENTHESES = ()

QUANTIFIERS-MULTIPLE CHOICE TEST



1. Would you like _____ bread?

- a) a slice of
- b) a bar of
- c) a bunch of
- d) a can of

2. I eat _____ boiled egg every morning.

- a) a
- b) an
- c) a few
- d) a little

3. Can you give me _____ tomato juice?

- a) a few
- b) many
- c) some
- d) any

4. How _____ carrots do you need?

- a) much
- b) many
- c) a few
- d) a little

5. I ate only _____ cake tonight.

- a) a loaf of
- b) a bottle of
- c) a pinch of
- d) a piece of

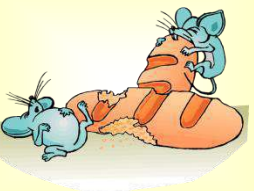

6. We have _____ bread, don't we?

- a) a few
- b) a little
- c) too many
- d) too much

7. There aren't _____ eggs in the basket.

- a) too much
- b) a lot of
- c) any
- d) some

8. You should eat _____ orange every day.

- a) a
- b) an
- c) any
- d) a few

9. There is _____ cheese on the plate.

- a) some
- b) many
- c) any
- d) a few

10. There is _____ honey in the pot.

- a) any
- b) many
- c) a lot of
- d) a few



11. Please give me _____ onions.

- a) a lot
- b) a few
- c) too much
- d) a little

12. There isn't _____ water in the glass.

- a) a few
- b) many
- c) an
- d) any

13. How _____ chicken would you like, sir?

- a) much
- b) many
- c) a few
- d) a little

14. There is _____ milk in the baby bottle.

- a) many
- b) a lot of
- c) a few
- d) any

15. We have _____ strawberries here.

- a) a little
- b) a lot of
- c) any
- d) too much

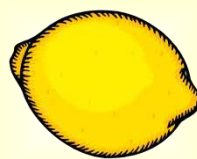

16. We have _____ strawberry jam.

- a) a bar of
- b) a bottle of
- c) a jar of
- d) a can of

17. Don't put _____ salt in the soup.

- a) a few
- b) many
- c) too much
- d) too many

18. I'll make _____ lemonade to drink.

- a) a few
- b) many
- c) any
- d) some

19. There is _____ food on the table.

- a) too much
- b) too many
- c) a few
- d) many

20. Give me _____ coke with the pizza.

- a) a can of
- b) a jar of
- c) a bunch of
- d) a pinch of

QUANTIFIERS-MULTIPLE CHOICE TEST ANSWER KEY



1. Would you like ____ bread?
a) a slice of
 b) a bar of
 c) a bunch of
 d) a can of

2. I eat ____ boiled egg every morning.
a) a
 b) an
 c) a few
 d) a little

3. Can you give me ____ tomato juice?
 a) a few
 b) many
c) some
 d) any

4. How ____ carrots do you need?
 a) much
b) many
 c) a few
 d) a little

5. I ate only ____ cake tonight.
 a) a loaf of
 b) a bottle of
 c) a pinch of
d) a piece of



6. We have ____ bread, don't we?
 a) a few
 b) a little
 c) too many
d) too much

7. There aren't ____ eggs in the basket.
 a) too much
 b) a lot of
c) any
 d) some

8. You should eat ____ orange every day.
 a) a
b) an
 c) any
 d) a few

9. There is ____ cheese on the plate.
a) some
 b) many
 c) any
 d) a few

10. There is ____ honey in the pot.
 a) any
 b) many
c) a lot of
 d) a few

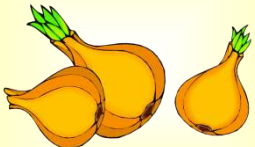

11. Please give me ____ onions.
 a) a lot
b) a few
 c) too much
 d) a little

12. There isn't ____ water in the glass.
 a) a few
 b) many
 c) an
d) any

13. How ____ chicken would you like, sir?
a) much
 b) many
 c) a few
 d) a little

14. There is ____ milk in the baby bottle.
 a) many
b) a lot of
 c) a few
 d) any

15. We have ____ strawberries here.
 a) a little
b) a lot of
 c) any
 d) too much

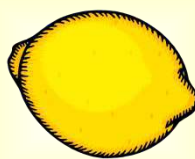

16. We have ____ strawberry jam.
 a) a bar of
 b) a bottle of
c) a jar of
 d) a can of

17. Don't put ____ salt in the soup.
 a) a few
 b) many
c) too much
 d) too many

18. I'll make ____ lemonade to drink.
 a) a few
 b) many
 c) any
d) some

19. There is ____ food on the table.
a) too much
 b) too many
 c) a few
 d) many

20. Give me ____ coke with the pizza.
a) a can of
 b) a jar of
 c) a bunch of
 d) a pinch of

CONTAINERS AND QUANTITIES ESL WORKSHEET

Look at the word list below and write them under the correct pictures

- a roll of
- a slice of
- a bottle of
- a bucket of
- a glass of
- a bar of
- a spoon of
- a jug of
- a cup of
- a head of
- a box of
- a piece of
- a carton of
- a loaf of
- a bunch of
- a bowl of
- a can of
- a bag of
- a jar of
- a tube of

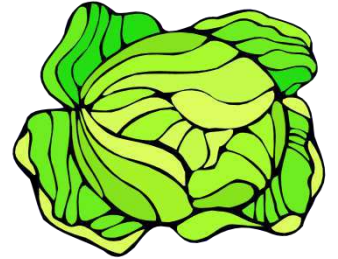

_____ chocolate

_____ water

_____ cereal

_____ cabbage

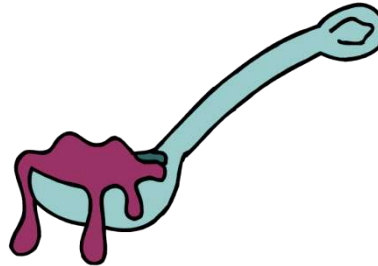
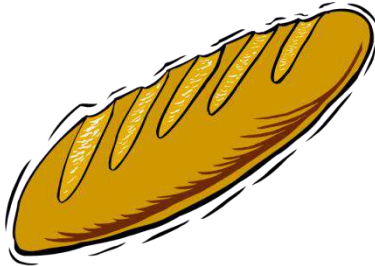
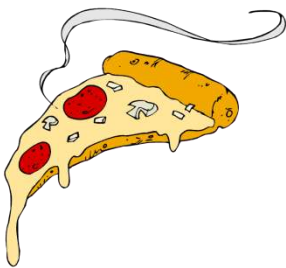

_____ pizza

_____ bread

_____ syrup

_____ toilet paper



_____ paint

_____ milk

_____ soup

_____ milk

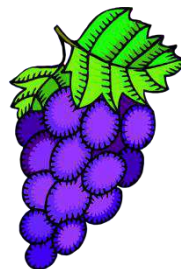

_____ coke

_____ toothpaste

_____ grapes

_____ jam

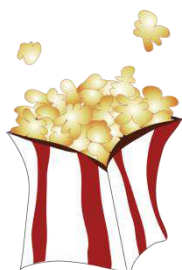

_____ coffee

_____ popcorn

_____ cake

_____ orange juice

CONTAINERS AND QUANTITIES ESL WORKSHEET ANSWER KEY

Look at the word list below and write them under the correct pictures

- a roll of
- a slice of
- a bottle of
- a bucket of
- a glass of
- a bar of
- a spoon of
- a jug of
- a cup of
- a head of
- a box of
- a piece of
- a carton of
- a loaf of
- a bunch of
- a bowl of
- a can of
- a bag of
- a jar of
- a tube of



a bar of chocolate



a bottle of water



a box of cereal

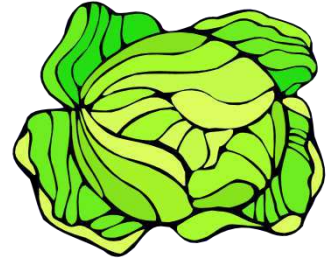

a head of cabbage

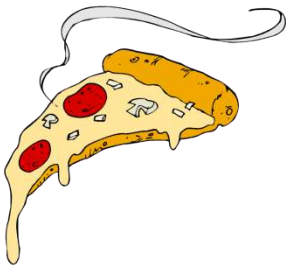

a slice of pizza

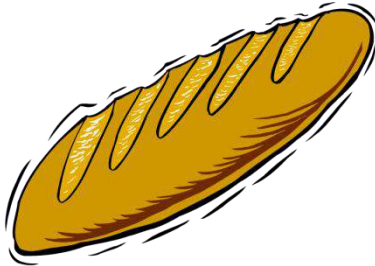

a loaf of bread

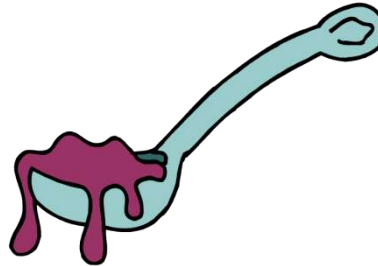

a spoon of syrup



a roll of toilet paper



a bucket of paint



a carton of milk



a bowl of soup



a jug of milk



a can of coke



a tube of toothpaste

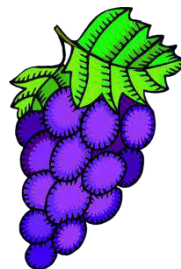

a bunch of grapes



a jar of jam



a cup of coffee



a bag of popcorn

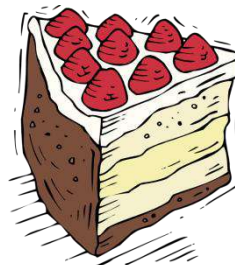

a piece of cake



a glass of orange juice

A FEW OR A LITTLE



Fill in the blanks with "a few" or "a little" to complete the sentences.



There are ___ students at the bus stop.



I can see only ___ apples in the bowl.

The cook is putting ___ olive oil into the vegetable soup.



I want ___ sugar for my tea. Can you add it, please?



Ruby wants to take ___ photographs of the birds.



I want ___ jam on my bread. I like jam and bread.

There are ___ coloured pencils and a book on the table.



Mr. Turner is carrying ___ boxes. He doesn't need any help.



Dad, I have got only ___ homework today. Can you help me, please?



Suzy has got ___ kittens. She wants to sell them.

You are very fat, dear. You should only eat ___ bread every day.



I think I will add ___ ketchup to my chips. I like ketchup.



___ painters are painting the wall. They are using green and yellow.



I'm having a difficult exam and I have got only ___ time.

Susan needs ___ cucumbers for the salad.

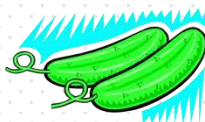

Look! ___ birds are flying over that yellow house.



Mr. Sad is unhappy because he has got only ___ money.



___ racers are running to the finish line.

Sir, I have got ___ questions about the plan.



There is only ___ water in that glass. I want some more.

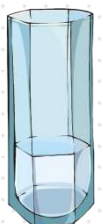

My grandmother adds ___ flour to the omelette.



There are ___ easter eggs in front of the rabbit.

A FEW OR A LITTLE ANSWER KEY



Fill in the blanks with "a few" or "a little" to complete the sentences.



There are **a few** students at the bus stop.



I can see only **a few** apples in the bowl.

The cook is putting **a little** olive oil into the vegetable soup.



I want **a little** sugar for my tea. Can you add it, please?



Ruby wants to take **a few** photographs of the birds.



I want **a little** jam on my bread. I like jam and bread.

There are **a few** coloured pencils and a book on the table.



Mr. Turner is carrying **a few** boxes. He doesn't need any help.



Dad, I have got only **a little** homework today. Can you help me, please?



Suzy has got **a few** kittens. She wants to sell them.

You are very fat, dear. You should only eat **a little** bread every day.



I think I will add **a little** ketchup to my chips. I like ketchup.



A few painters are painting the wall. They are using green and



I'm having a difficult exam and I have got only **a little** time.

Susan needs **a few** cucumbers for the salad.

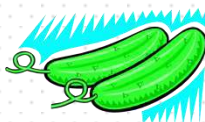

Look! **A few** birds are flying over that yellow house.



Mr. Sad is unhappy because he has got only **a little** money.



A few racers are running to the finish line.

Sir, I have got **a few** questions about the plan.



There is only **a little** water in that glass. I want some more.

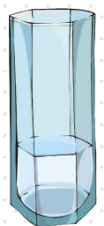

My grandmother adds **a little** flour to the omelette.



There are **a few** easter eggs in front of the rabbit.

PARTY TYPES PICTURE DICTIONARY



birthday party



graduation party



sleepover party



costume party



wedding party



barbeque party



office party



dance party



beach party



karaoke party



tea party



dinner party



pool party



Christmas party



Easter party



Halloween party

PARTY TYPES PICTURE DICTIONARY



birthday party



graduation party



sleepover party



costume party



wedding party



barbeque party



office party



dance party



beach party



karaoke party



tea party



dinner party



pool party



Christmas party

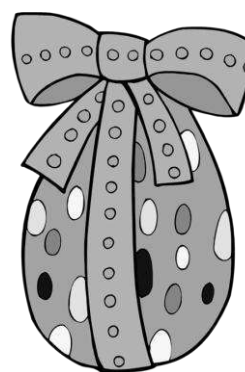

Easter party



Halloween party

PARTY TYPES VOCABULARY MATCHING WORKSHEET

Choose the correct words from the list below and write them under the correct pictures





WORD LIST

- birthday party
- graduation party
- sleepover party
- costume party
- wedding party
- barbecue party
- office party
- dance party
- beach party
- karaoke party
- tea party
- dinner party
- pool party
- Christmas party
- Easter party
- Halloween party







PARTY TYPES VOCABULARY MATCHING WORKSHEET ANSWER KEY

Choose the correct words from the list below and write them under the correct pictures



barbecue party



Christmas party



costume party



beach party



pool party



office party

WORD LIST

- birthday party
- graduation party
- sleepover party
- costume party
- wedding party
- barbecue party
- office party
- dance party
- beach party
- karaoke party
- tea party
- dinner party
- pool party
- Christmas party
- Easter party
- Halloween party



sleepover party



tea party



Halloween party



wedding party



birthday party



karaoke party



Easter party



graduation party



dinner party



dance party

PARTY TYPES VOCABULARY WORD SEARCH PUZZLE

Find and circle the words in the word search puzzle and number the pictures

y	w	i	u	t	m	s	l	e	e	p	o	v	e	r	p	a	r	t	y
t	c	r	z	o	f	f	i	c	e	p	a	r	t	y	t	z	v	u	m
c	o	s	t	u	m	e	p	a	r	t	y	a	e	h	t	u	g	q	y
w	h	s	j	u	u	q	x	n	f	g	l	g	y	q	g	a	x	l	n
d	a	n	c	e	p	a	r	t	y	e	a	r	f	u	o	b	b	n	b
f	l	k	z	i	i	s	f	n	t	e	a	p	a	r	t	y	c	y	
x	l	a	q	t	y	n	v	n	n	f	v	d	e	e	g	p	p	h	w
a	o	r	w	h	s	t	j	h	m	p	h	u	e	p	e	p	c	r	t
d	w	a	b	a	r	b	e	c	u	e	p	a	r	t	y	r	s	i	b
i	e	o	q	k	c	d	h	r	x	y	a	t	n	z	m	u	a	s	e
n	e	k	l	m	q	s	m	k	y	y	q	i	h	w	h	m	c	t	a
n	n	e	s	c	p	w	o	w	f	e	t	o	c	p	u	s	f	m	c
e	p	p	y	x	v	t	c	l	x	j	x	n	h	a	a	b	t	a	h
r	a	a	k	b	i	r	t	h	d	a	y	p	a	r	t	y	b	s	p
p	r	r	b	s	v	k	k	c	r	a	l	a	p	x	a	d	p	p	a
a	t	t	m	z	z	s	y	f	i	b	c	r	w	l	h	l	w	a	r
r	y	y	e	m	p	q	y	t	r	u	c	t	q	d	x	w	n	r	t
t	p	e	a	s	t	e	r	p	a	r	t	y	p	g	d	s	i	t	y
y	r	b	f	c	s	c	j	j	y	p	o	o	l	p	a	r	t	y	o
e	x	f	w	e	d	d	i	n	g	p	a	r	t	y	x	w	n	x	h



1. birthday party
2. graduation party
3. sleepover party
4. costume party
5. wedding party
6. barbecue party
7. office party
8. dance party
9. beach party
10. karaoke party
11. tea party
12. dinner party
13. pool party
14. Christmas party
15. Easter party
16. Halloween party

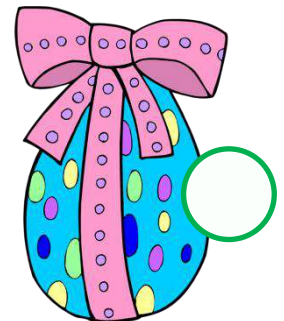
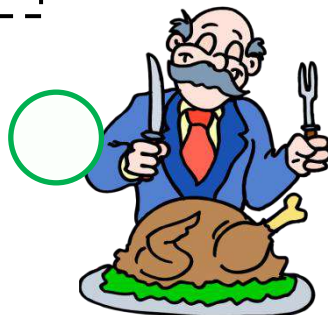

PARTY TYPES VOCABULARY WORD SEARCH PUZZLE ANSWER KEY

Find and circle the words in the word search puzzle and number the pictures

y	w	i	u	t	m	s	l	e	e	p	o	v	e	r	p	a	r	t	y
t	c	r	z	o	f	f	i	c	e	p	a	r	t	y	t	z	v	u	m
c	o	s	t	u	m	e	p	a	r	t	y	a	e	h	t	u	g	q	y
w	h	s	j	u	u	q	x	n	f	g	l	g	y	q	g	a	x	l	n
d	a	n	c	e	p	a	r	t	y	e	a	r	f	u	o	b	b	n	b
f	l	k	z	i	i	s	f	n	t	e	a	p	a	r	t	y	c	y	
x	l	a	q	t	y	n	v	n	n	f	v	d	e	e	g	p	p	h	w
a	o	r	w	h	s	t	j	h	m	p	h	u	e	p	e	p	c	r	t
d	w	a	b	a	r	b	e	c	u	e	p	a	r	t	y	r	s	i	b
i	e	o	q	k	c	d	h	r	x	y	a	t	n	z	m	u	a	s	e
n	e	k	l	m	q	s	m	k	y	y	q	i	h	w	h	m	c	t	a
n	n	e	s	c	p	w	o	w	f	e	t	o	c	p	u	s	f	m	c
e	p	p	y	x	v	t	c	l	x	j	x	n	h	a	a	b	t	a	h
r	a	a	k	b	i	r	t	h	d	a	y	p	a	r	t	y	b	s	p
p	r	r	b	s	v	k	k	c	r	a	l	a	p	x	a	d	p	p	a
a	t	t	m	z	z	s	y	f	i	b	c	r	w	l	h	l	w	a	r
r	y	y	e	m	p	q	y	t	r	u	c	t	q	d	x	w	n	r	t
t	p	e	a	s	t	e	r	p	a	r	t	y	p	g	d	s	i	t	y
y	r	b	f	c	s	c	j	j	y	p	o	o	l	p	a	r	t	y	o
e	x	f	w	e	d	d	i	n	g	p	a	r	t	y	x	w	n	x	h

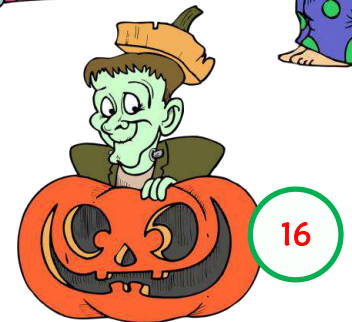
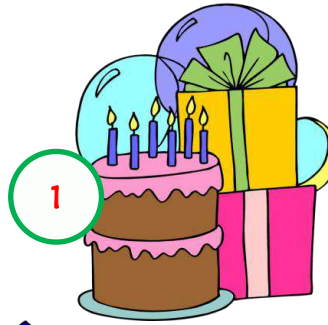

1. birthday party
2. graduation party
3. sleepover party
4. costume party
5. wedding party
6. barbecue party
7. office party
8. dance party
9. beach party
10. karaoke party
11. tea party
12. dinner party
13. pool party
14. Christmas party
15. Easter party
16. Halloween party

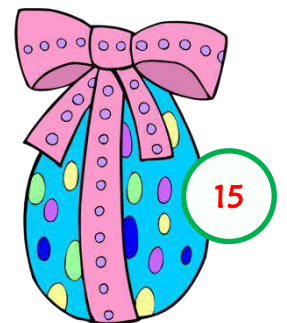
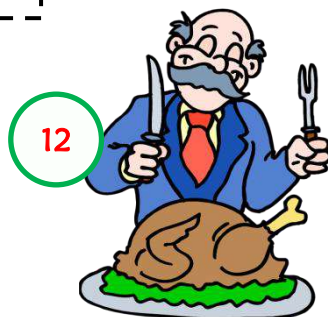

PARTY TYPES CROSSWORD PUZZLE

Look at the numbers on the pictures and write the party types vocabulary in the crossword puzzle

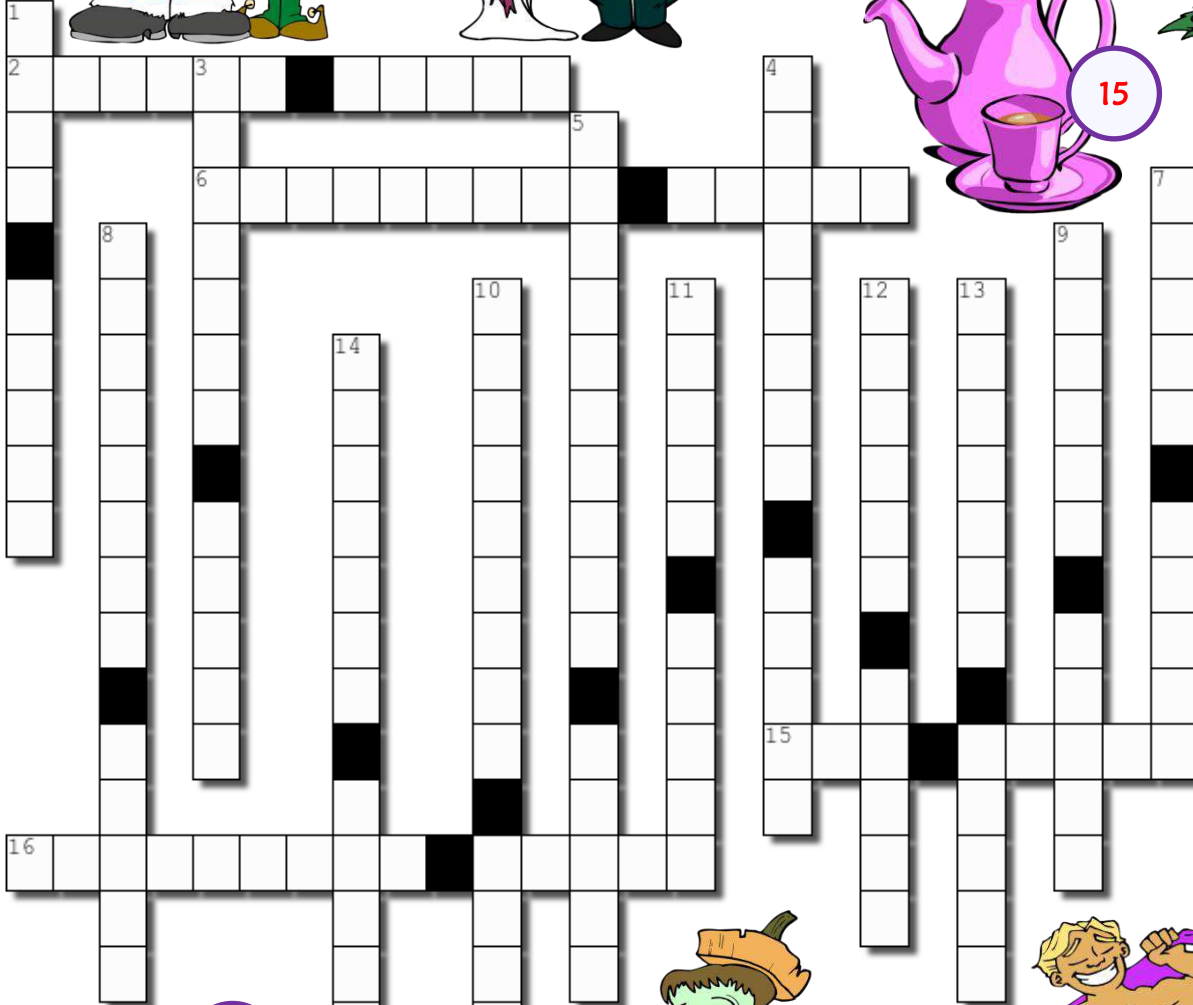
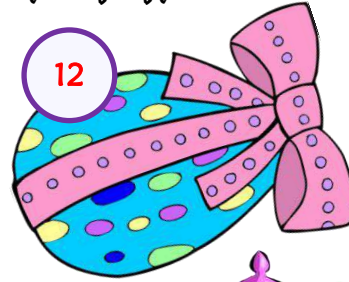

ANSWER KEY

Across

2. office party

6. sleepover party

15. tea party

16. Christmas party

Down

1. pool party

3. costume party

4. birthday party

5. graduation party

7. beach party

8. barbeque party

9. dinner party

10. Halloween party

11. dance party

12. Easter party

13. karaoke party

14. wedding party

PARTY TYPES MISSING LETTERS IN WORDS

Write the missing letters in the boxes to complete the party types vocabulary



b_rthd_y party

gr_d__t__n party



sl__p_v_r party



c_st_m_ party



w_dd_ng party

b_rb_c__ party



_ff_c_ party



d_nc_ party



b__ch party

k_r__k_ party



t__ party



d_nn_r party



p__l party

Chr_stm_s party



_st_r party



H_ll_w__n party

PARTY TYPES MISSING LETTERS IN WORDS ANSWER KEY

Write the missing letters in the boxes to complete the party types vocabulary



birthday party

graduation party



sleepover party



costume party



wedding party

barbecue party



office party



dance party



beach party

karaoke party



tea party



dinner party



pool party

Christmas party



Easter party



Halloween party



PARTY TYPES UNSCRAMBLE THE WORDS

Unscramble the party types vocabulary and number the pictures



1. ibdaythr paytr _____

2. otdgrunaia ytrpa _____

3. ospvreee tpyar _____

4. emustco yaptr _____

5. neidgdw prtya _____

6. bubarcee yartp _____

7. cfiofe raptv _____

8. cdena aytrp _____

9. cheab ytarv _____

10. krakoe trpya _____

11. aet taryp _____

12. idernn tapyr _____

13. opol tryap _____

14. smrahtsCi trypa _____

15. sareEt atypr _____

16. Haeenlwlo pytra _____

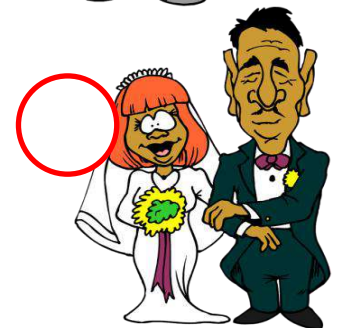
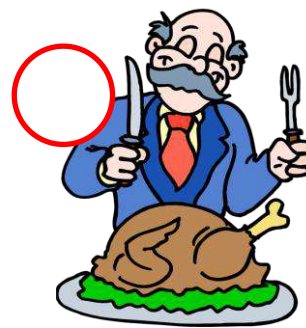
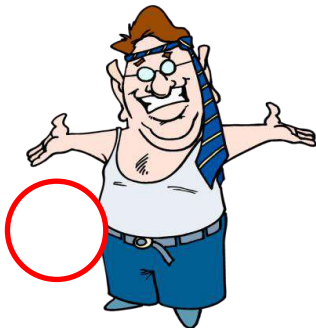
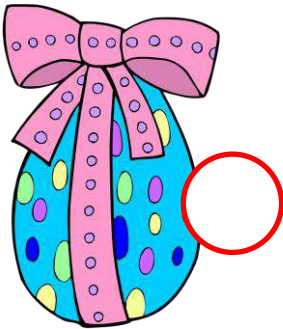

PARTY TYPES UNSCRAMBLE THE WORDS ANSWER KEY

Unscramble the party types vocabulary and number the pictures



11



10



9



13



16



4

1. ibdaythr paytr **birthday party**
2. otdgrunaia yrtpa **graduation party**
3. osplvreee tpyar **sleepover party**
4. emustco yaptr **costume party**
5. neidgdw prtya **wedding party**
6. bubarcee yartp **barbecue party**
7. cfiofe rapyt **office party**
8. cdena aytrp **dance party**
9. cheab ytarp **beach party**
10. krakoe trpya **karaoke party**
11. aet taryp **tea party**
12. idenrn tapyr **dinner party**
13. opol tryap **pool party**
14. smrahtsCi trypa **Christmas party**
15. sareEt atypr **Easter party**
16. Haeenlwlo pytra **Halloween party**



3



14



6



8

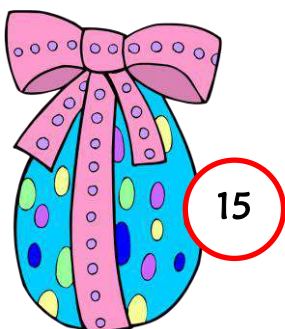

15



2



7

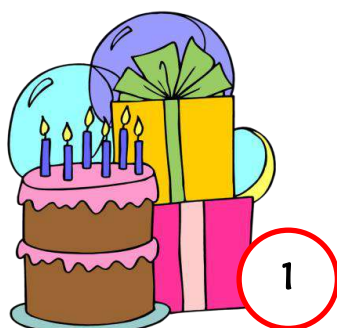

1

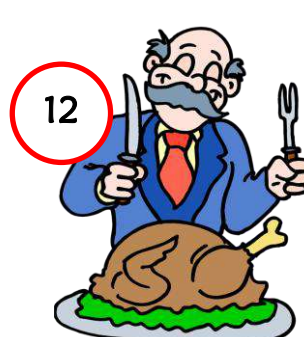

12



5

PARTY TYPES MULTIPLE CHOICE TEST

Look at the pictures, choose and circle the correct option.



- a) office party
- b) birthday party
- c) karaoke party
- d) Halloween party



- a) Christmas party
- b) wedding party
- c) graduation party
- d) beach party



- a) sleepover party
- b) dinner party
- c) barbecue party
- d) pool party

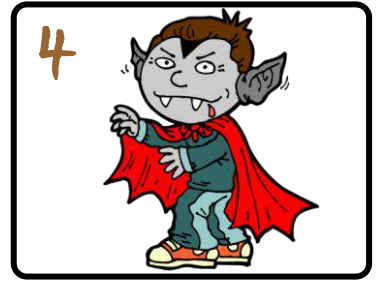

- a) tea party
- b) office party
- c) Easter party
- d) costume party



- a) Easter party
- b) tea party
- c) wedding party
- d) sleepover party



- a) costume party
- b) barbecue party
- c) beach party
- d) pool party



- a) Halloween party
- b) dinner party
- c) birthday party
- d) office party



- a) graduation party
- b) dance party
- c) karaoke party
- d) Christmas party



- a) beach party
- b) graduation party
- c) Easter party
- d) barbecue party



- a) sleepover party
- b) wedding party
- c) karaoke party
- d) Halloween party



- a) dance party
- b) costume party
- c) tea party
- d) pool party

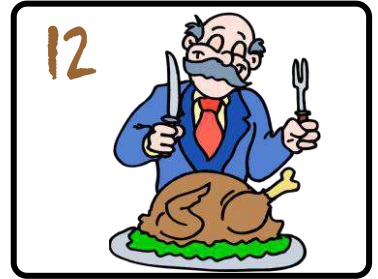

- a) dinner party
- b) Christmas party
- c) office party
- d) birthday party



- a) office party
- b) birthday party
- c) tea party
- d) pool party



- a) dinner party
- b) Christmas party
- c) sleepover party
- d) dance party



- a) karaoke party
- b) barbecue party
- c) graduation party
- d) Easter party



- a) Halloween party
- b) costume party
- c) beach party
- d) wedding

PARTY TYPES MULTIPLE CHOICE TEST ANSWER KEY

TEST 1

1) b

2) c

3) a

4) d

5) c

6) b

7) d

8) b

9) a

10) c

11) c

12) a

13) d

14) b

15) d

16) a



birthday party



graduation party



sleepover party



costume party



wedding party



barbeque party



office party



dance party



beach party



karaoke party



tea party



dinner party



pool party



Christmas party



Easter party



Halloween party























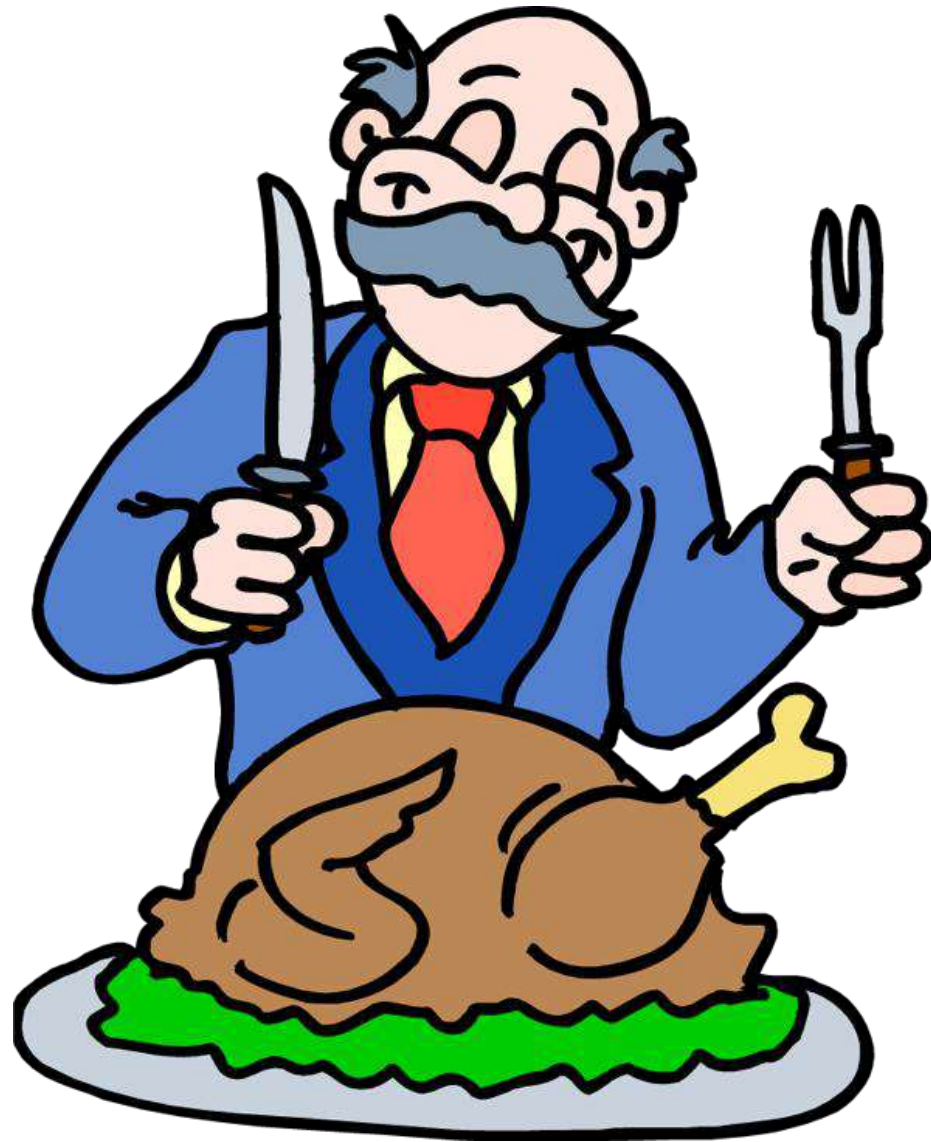





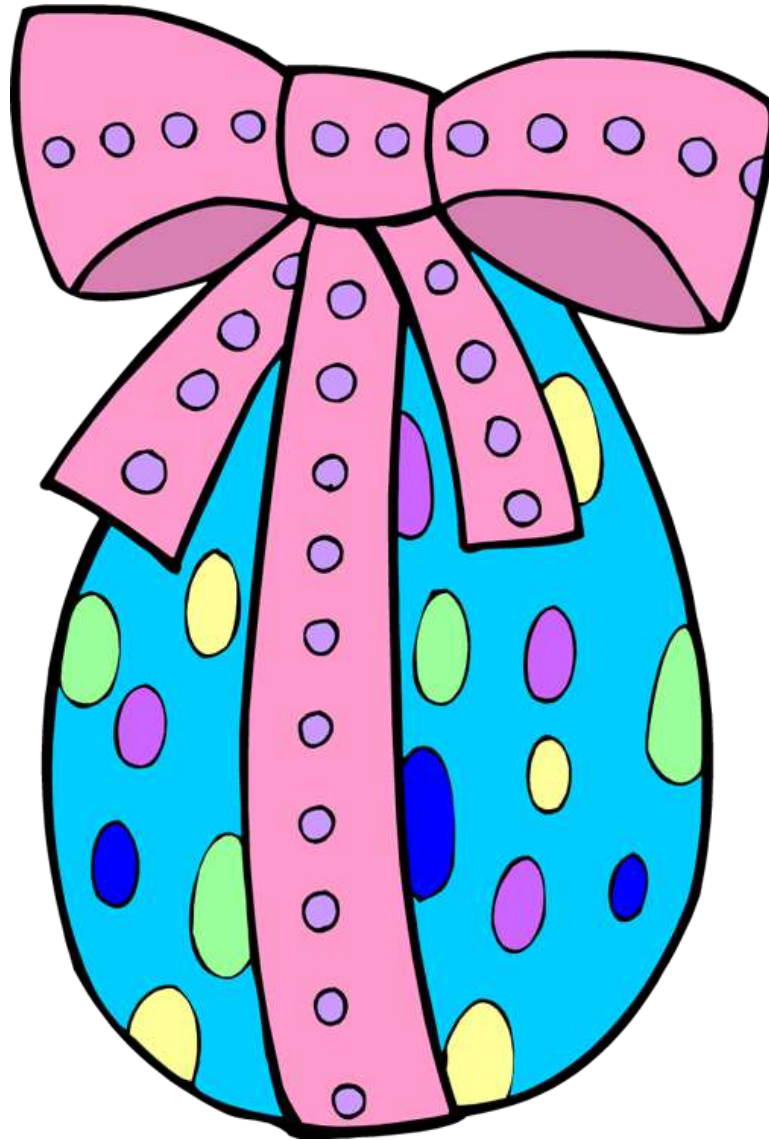





birthday party

Copyright © 09/11/2019 englishsheets.com. All rights reserved.



graduation party

Copyright © 09/11/2019 englishsheets.com. All rights reserved.



sleepover party

Copyright © 09/11/2019 englishsheets.com. All rights reserved.



costume party

Copyright © 09/11/2019 englishsheets.com. All rights reserved.



wedding party

Copyright © 09/11/2019 englishsheets.com. All rights reserved.



barbeque party

Copyright © 09/11/2019 englishsheets.com. All rights reserved.



office party

Copyright © 09/11/2019 englishsheets.com. All rights reserved.



dance party

Copyright © 09/11/2019 englishsheets.com. All rights reserved.



beach party

Copyright © 09/11/2019 englishsheets.com. All rights reserved.



karaoke party

Copyright © 09/11/2019 englishsheets.com. All rights reserved.



tea party

Copyright © 09/11/2019 englishsheets.com. All rights reserved.

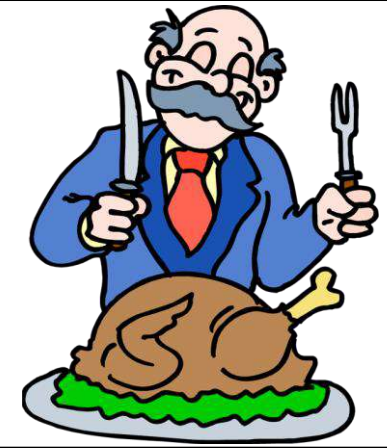

dinner party

Copyright © 09/11/2019 englishsheets.com. All rights reserved.



pool party

Copyright © 09/11/2019 englishsheets.com. All rights reserved.



Christmas party

Copyright © 09/11/2019 englishsheets.com. All rights reserved.



Easter party

Copyright © 09/11/2019 englishsheets.com. All rights reserved.



Halloween party

Copyright © 09/11/2019 englishsheets.com. All rights reserved.

PARTY TYPES FIDGET SPINNER GAME

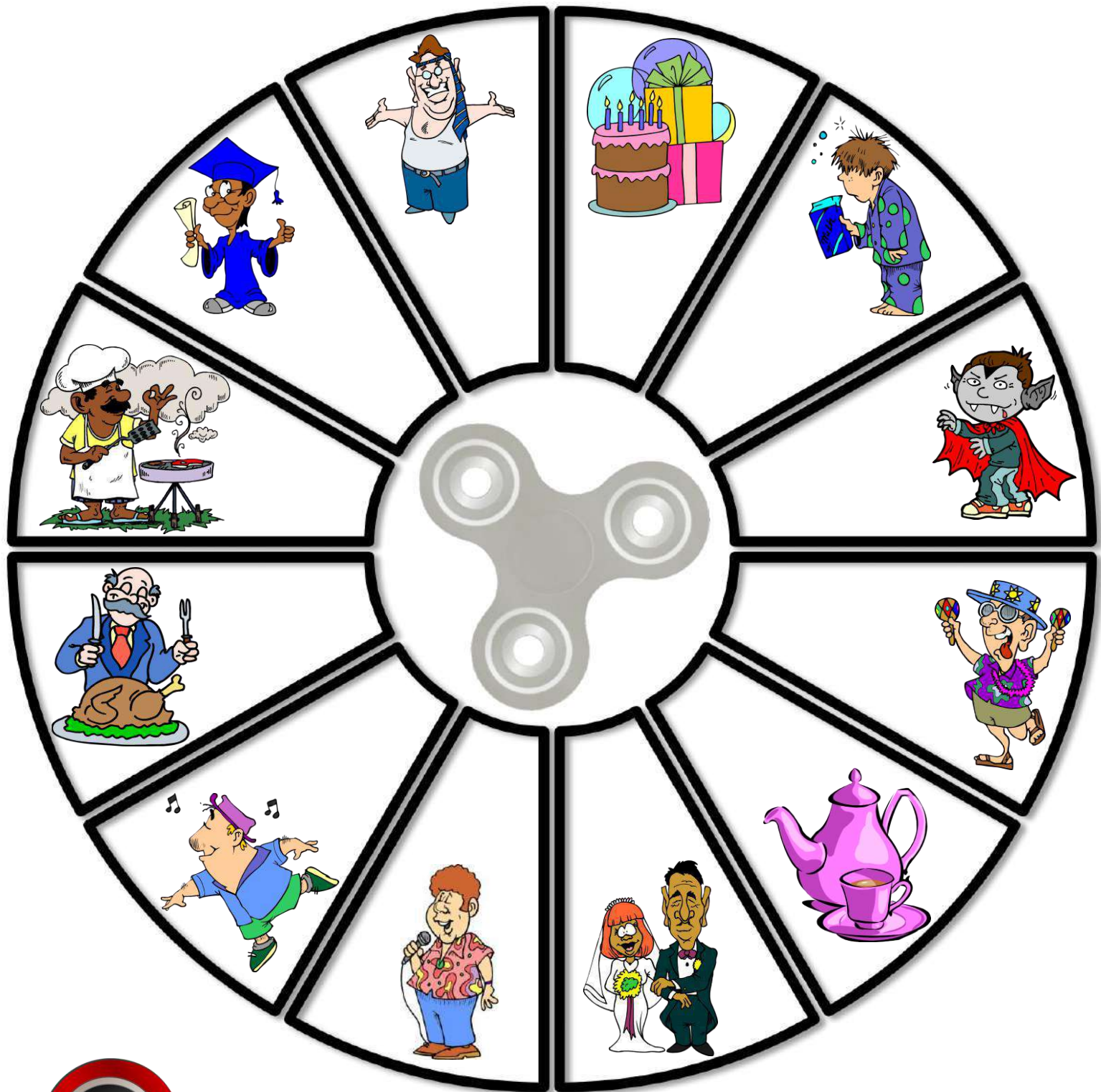

- Cut a small arrow from paper or craft foam and stick it onto the fidget spinner as your pointer.
- Place the fidget spinner in the middle of the vocabulary circle.
- Spin it and say the word quickly!

PARTY TYPES FIDGET SPINNER GAME

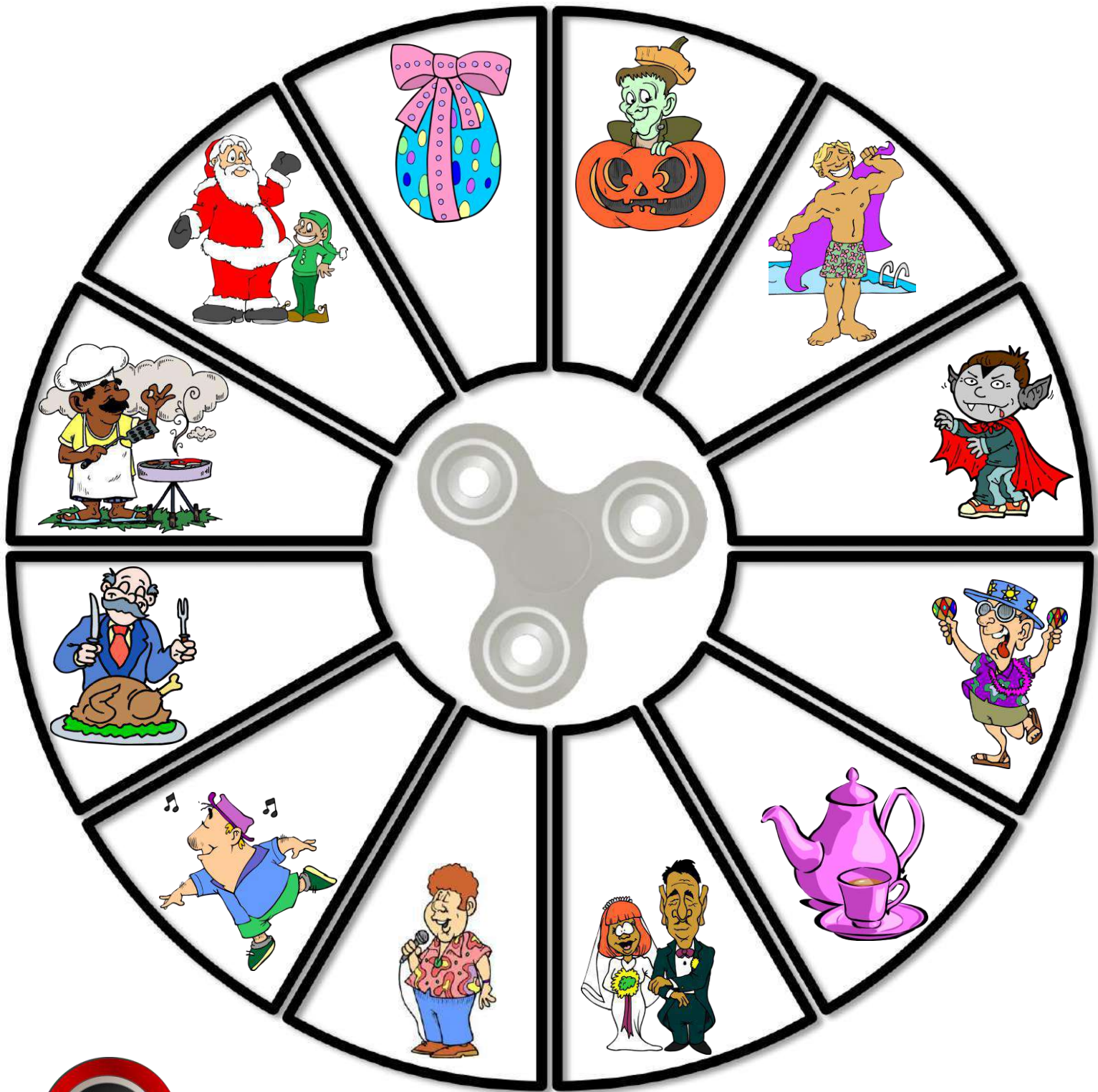

- Cut a small arrow from paper or craft foam and stick it onto the fidget spinner as your pointer.
- Place the fidget spinner in the middle of the vocabulary circle.
- Spin it and say the word quickly!



birthday
party



graduation
party



sleepover
party



costume
party



wedding
party



barbeque
party



office party



dance party



beach party



karaoke party



tea party



dinner party



pool party



Christmas
party



Easter party



Halloween
party

PERSONAL CARE PRODUCTS PICTURE DICTIONARY !



perfume



deodorant



hand lotion



mirror



mouthwash

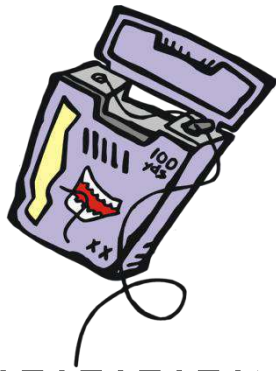

dental floss



toothbrush



toothpaste



lip balm

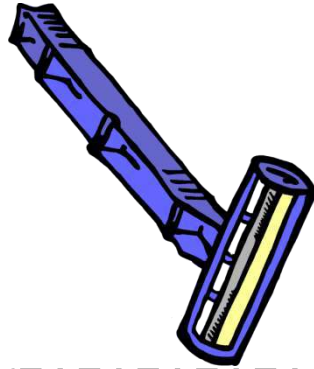

razor



shaving foam



shampoo



shower gel

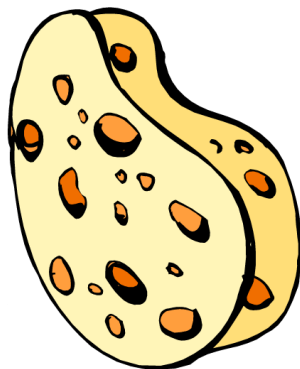

sponge



sunscreen



hair spray

PERSONAL CARE PRODUCTS PICTURE DICTIONARY 2



electric razor



hair dryer

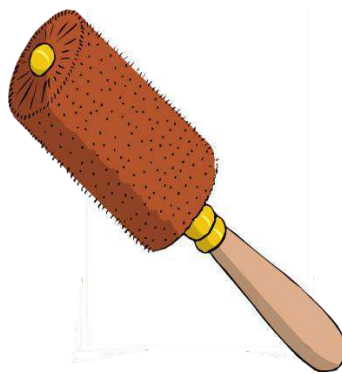

hairbrush



scissors



comb

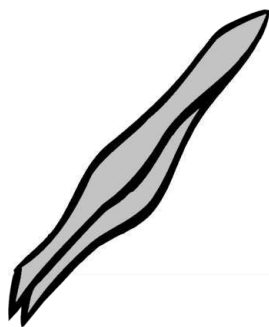

tweezers

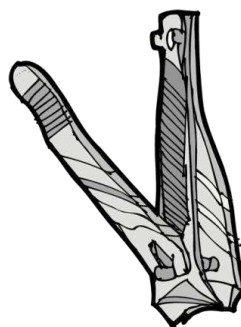

nail clippers

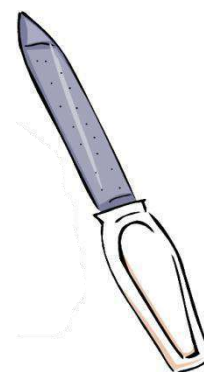

nail file

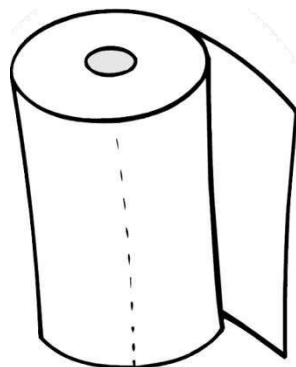

paper towel

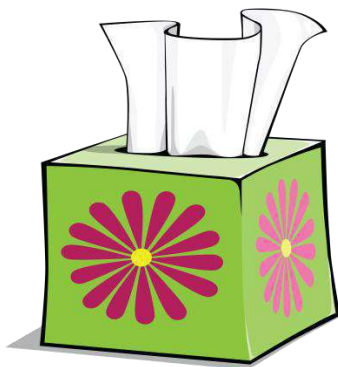

tissues

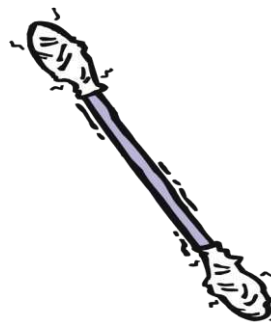

cotton bud

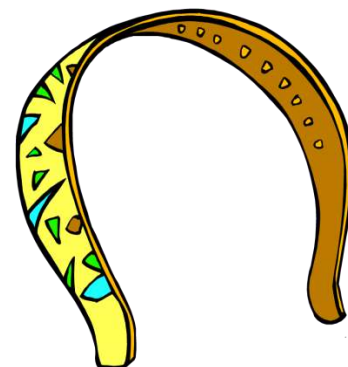

hairband

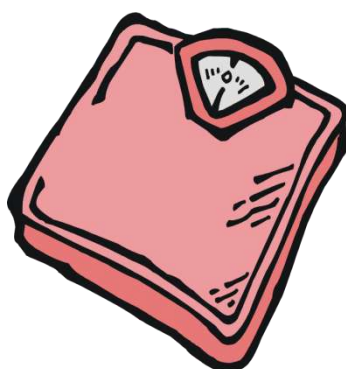

scales



sunglasses



hair clips

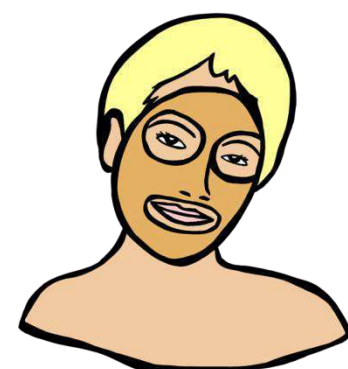

facial mask

PERSONAL CARE PRODUCTS PICTURE DICTIONARY 1



perfume



deodorant



hand lotion



mirror



mouthwash

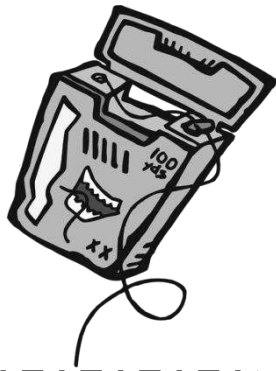

dental floss



toothbrush



toothpaste



lip balm

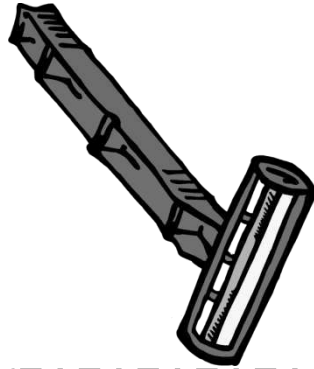

razor



shaving foam



shampoo



shower gel

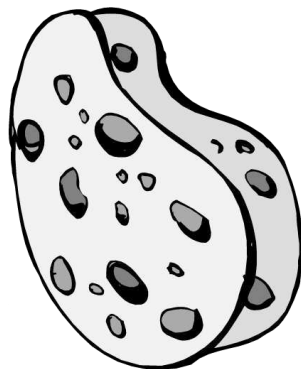

sponge



sunscreen



hair spray

PERSONAL CARE PRODUCTS PICTURE DICTIONARY 2



electric razor



hair dryer



hairbrush



scissors



comb

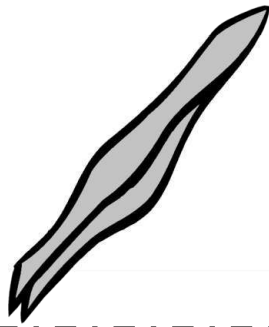

tweezers

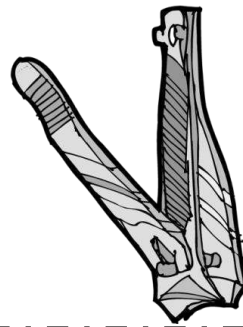

nail clippers

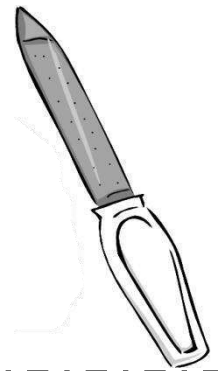

nail file

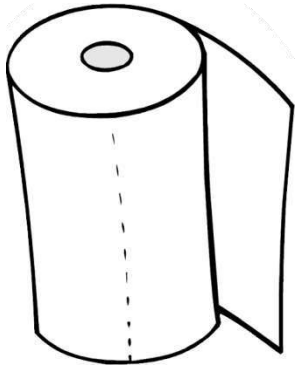

paper towel

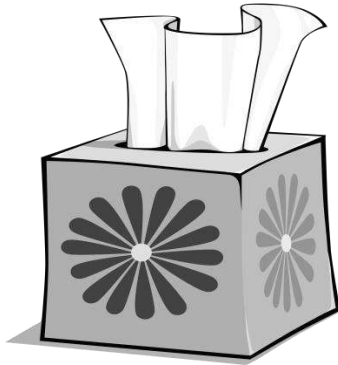

tissues

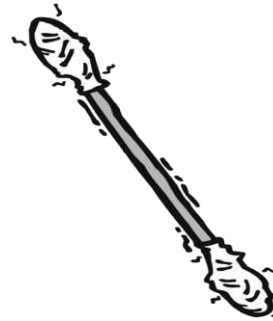

cotton bud

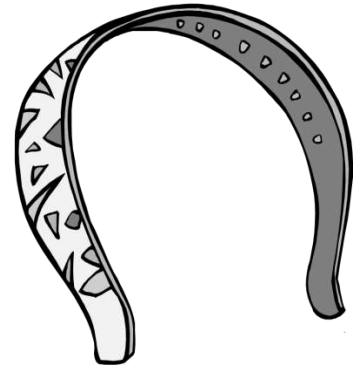

hairband



scales



sunglasses



hair clips

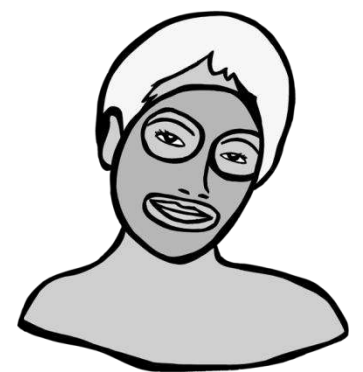

facial mask

PERSONAL CARE PRODUCTS VOCABULARY MATCHING WORKSHEET !

Choose the correct words from the list below and write them under the correct pictures



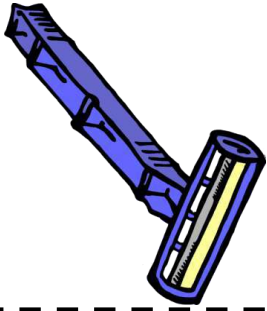

WORD LIST

- perfume
- deodorant
- hand lotion
- mirror
- mouthwash
- dental floss
- toothbrush
- toothpaste
- lip balm
- razor
- shaving foam
- shampoo
- shower gel
- sponge
- sunscreen
- hair spray

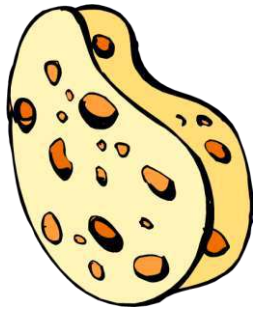

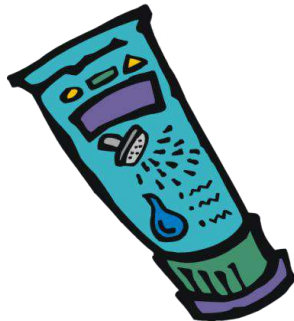

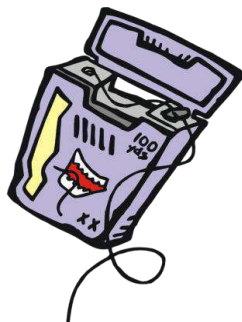

PERSONAL CARE PRODUCTS VOCABULARY MATCHING WORKSHEET 2

Choose the correct words from the list below and write them under the correct pictures

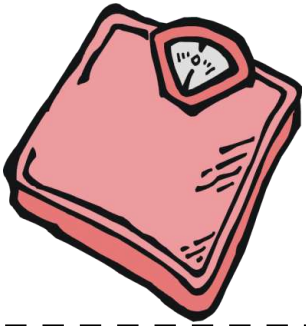
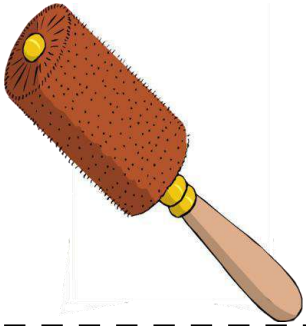
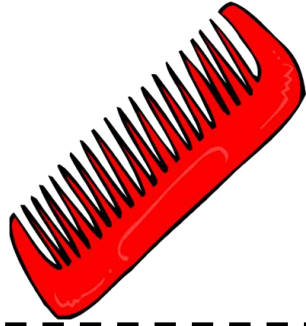
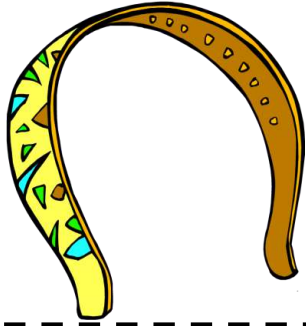
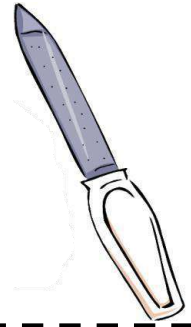
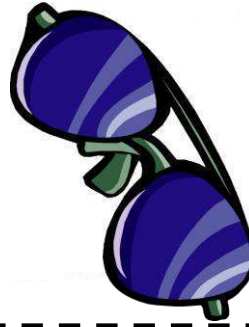
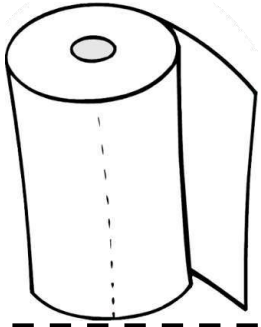

WORD LIST

- electric razor
- hair dryer
- hairbrush
- scissors
- comb
- tweezers
- nail clippers
- nail file
- paper towel
- tissues
- cotton bud
- hairband
- scales
- sunglasses
- hair clips
- facial mask

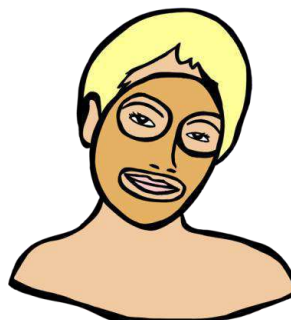
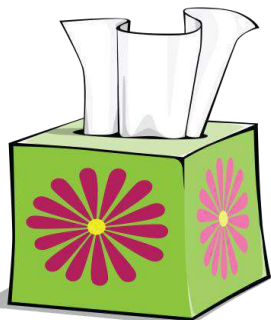
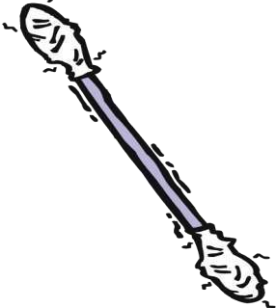
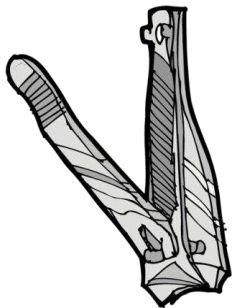

PERSONAL CARE PRODUCTS VOCABULARY MATCHING WORKSHEET | ANSWER KEY

Choose the correct words from the list below and write them under the correct pictures



hand lotion



lip balm



toothbrush



hair spray

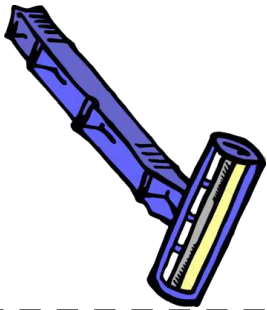

razor



perfume

WORD LIST

- perfume
- deodorant
- hand lotion
- mirror
- mouthwash
- dental floss
- toothbrush
- toothpaste
- lip balm
- razor
- shaving foam
- shampoo
- shower gel
- sponge
- sunscreen
- hair spray

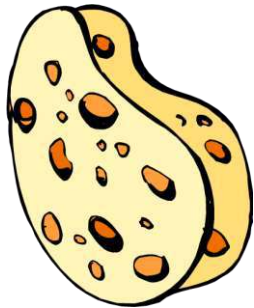

sponge



mouthwash



mirror



shower gel



toothpaste



shampoo



sunscreen

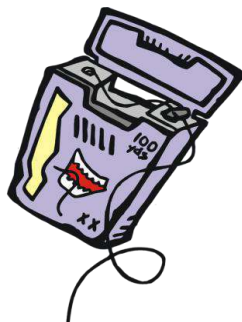

dental floss



deodorant



shaving foam

PERSONAL CARE PRODUCTS VOCABULARY MATCHING WORKSHEET 2 ANSWER KEY

Choose the correct words from the list below and write them under the correct pictures

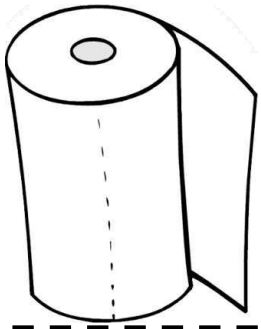

paper towel



scissors

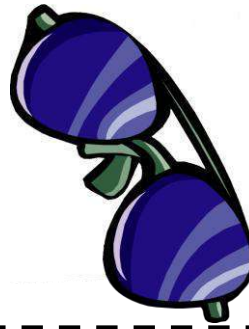

sunglasses

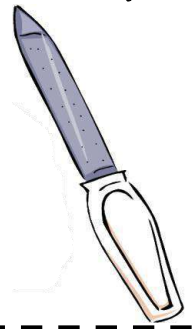

nail file

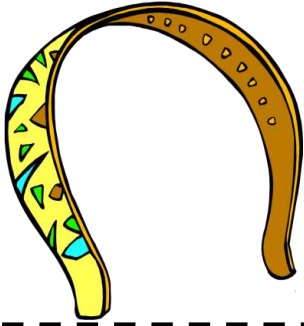

hairband



comb

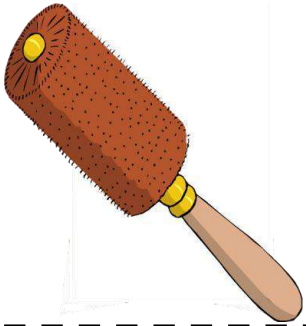

hairbrush



scales

WORD LIST

- electric razor
- hair dryer
- hairbrush
- scissors
- comb
- tweezers
- nail clippers
- nail file
- paper towel
- tissues
- cotton bud
- hairband
- scales
- sunglasses
- hair clips
- facial mask

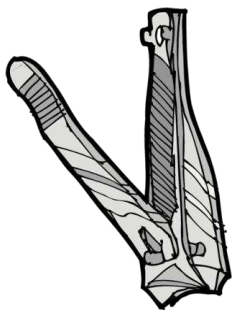

nail clippers

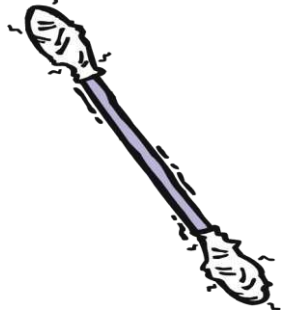

cotton bud



electric razor



hair clips

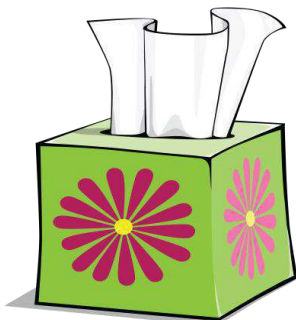

tissues



hair dryer

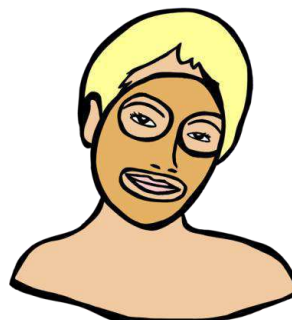

facial mask



tweezers

PERSONAL CARE PRODUCTS WORD SEARCH PUZZLE !

Find and circle the words in the word search puzzle and number the pictures

v	u	u	l	t	j	h	f	s	m	a	g	x	v	d
b	m	j	i	o	w	b	s	k	b	a	m	y	d	e
z	r	t	p	o	s	h	o	w	e	r	g	e	l	o
j	r	o	b	t	h	a	n	p	s	j	y	c	q	d
l	v	o	a	h	i	n	c	e	l	h	t	s	t	o
m	t	t	l	p	s	d	b	r	g	a	d	h	w	r
o	s	h	m	a	q	l	e	f	v	i	j	a	u	a
u	h	b	j	s	u	o	a	u	m	r	l	m	r	n
t	v	r	c	t	v	t	i	m	i	s	g	p	a	t
h	j	u	d	e	j	i	l	e	r	p	n	o	z	a
w	f	s	x	n	x	o	e	s	r	r	m	o	o	c
a	s	h	a	v	i	n	g	f	o	a	m	c	r	d
s	s	p	o	n	g	e	h	b	r	y	z	x	k	r
h	d	e	n	t	a	l	f	l	o	s	s	l	a	j
w	w	r	v	d	s	u	n	s	c	r	e	e	n	s

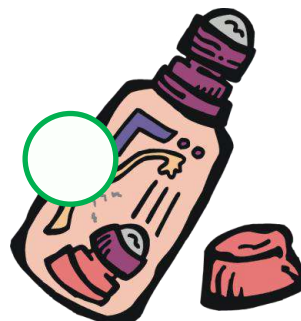
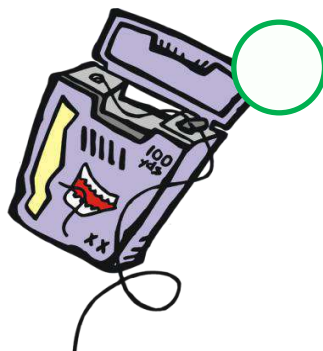
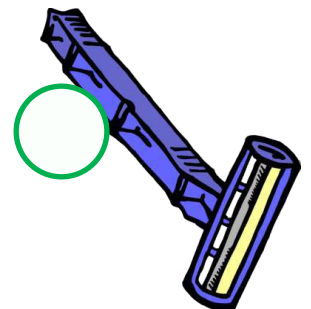
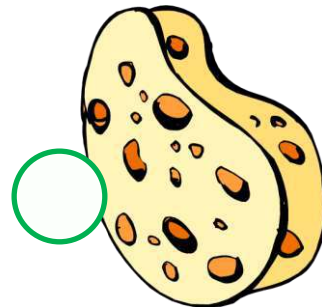
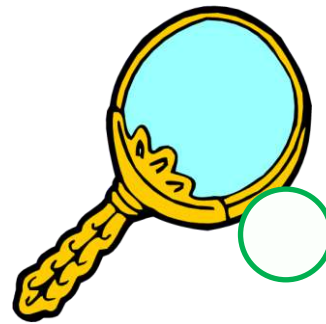
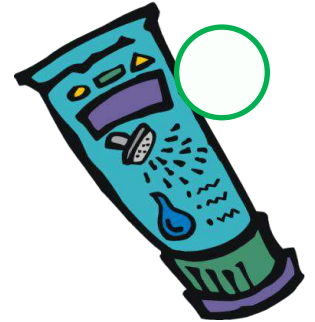
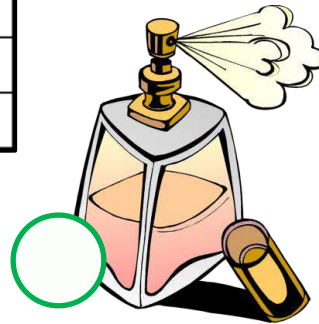
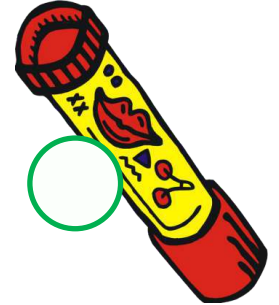

1. perfume
2. deodorant
3. hand lotion
4. mirror
5. mouthwash
6. dental floss
7. toothbrush
8. toothpaste
9. lip balm
10. razor
11. shaving foam
12. shampoo
13. shower gel
14. sponge
15. sunscreen
16. hair spray

PERSONAL CARE PRODUCTS WORD SEARCH PUZZLE 2

Find and circle the words in the word search puzzle and number the pictures

k	u	c	o	t	t	o	n	b	u	d	c	a	g	u
m	x	s	h	a	i	r	b	r	u	s	h	o	o	u
n	k	u	t	i	s	s	u	e	s	s	s	w	u	w
a	t	n	u	w	j	e	t	f	s	x	g	k	c	s
i	p	g	f	b	q	e	w	m	v	h	h	f	l	c
l	a	l	a	h	h	n	e	y	d	a	d	u	v	i
f	p	a	c	c	a	p	e	t	x	i	w	e	d	s
i	e	s	i	k	i	u	z	b	n	r	o	o	s	s
l	r	s	a	i	r	a	e	v	s	d	o	x	x	o
e	t	e	l	e	c	t	r	i	c	r	a	z	o	r
u	o	s	m	z	l	c	s	k	w	y	q	d	e	s
z	w	b	a	z	i	o	z	g	m	e	g	y	x	w
c	e	e	s	g	p	m	h	a	i	r	b	a	n	d
u	l	x	k	m	s	b	i	k	s	c	a	l	e	s
e	n	a	i	l	c	l	i	p	p	e	r	s	n	w

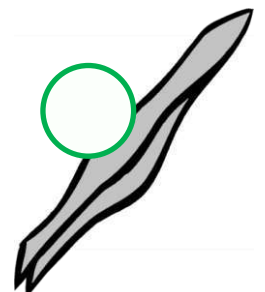
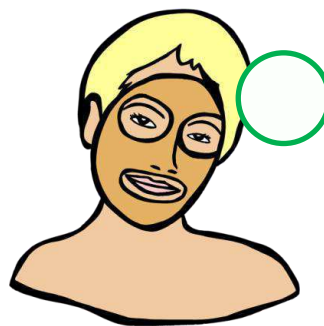
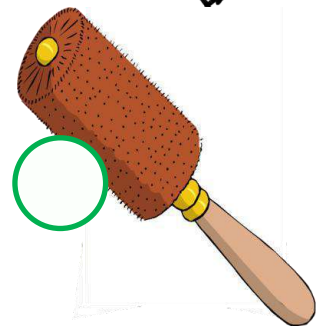
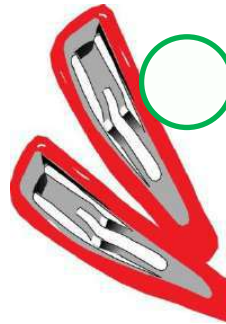
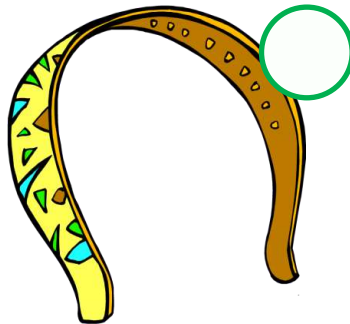
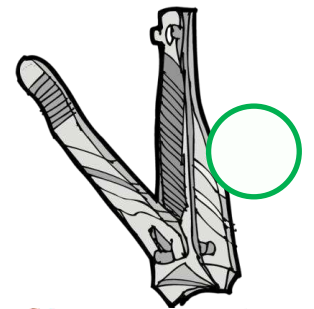
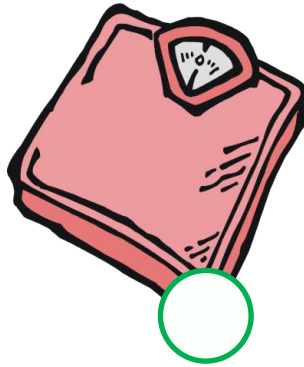
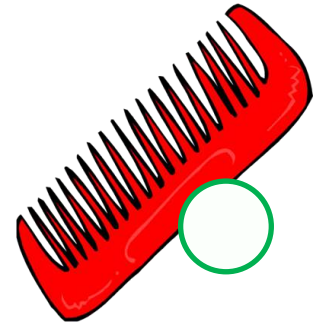
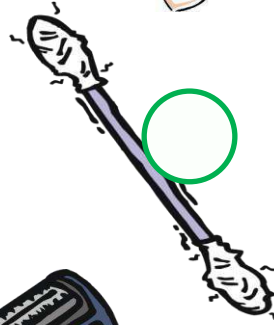
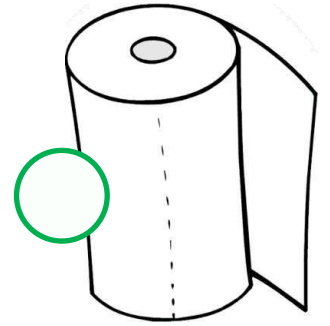
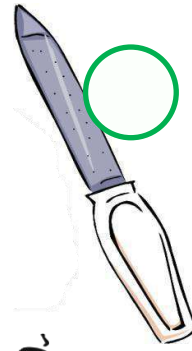
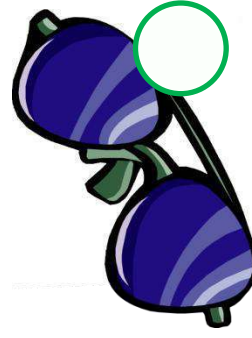

1. electric razor
2. hair dryer
3. hairbrush
4. scissors
5. comb
6. tweezers
7. nail clippers
8. nail file
9. paper towel
10. tissues
11. cotton bud
12. hairband
13. scales
14. sunglasses
15. hair clips
16. facial mask

PERSONAL CARE PRODUCTS WORD SEARCH PUZZLE | ANSWER KEY

Find and circle the words in the word search puzzle and number the pictures

v	u	u	l	t	j	h	f	s	m	a	g	x	v	d
b	m	j	i	o	w	b	s	k	b	a	m	y	d	e
z	r	t	p	o	s	h	o	w	e	r	g	e	l	o
j	r	o	b	t	h	a	n	p	s	j	y	c	q	d
l	v	o	a	h	i	n	c	e	l	h	t	s	t	o
m	t	t	l	p	s	d	b	r	g	a	d	h	w	r
o	s	h	m	a	q	l	e	f	v	i	j	a	u	a
u	h	b	j	s	u	o	a	u	m	r	l	m	r	n
t	v	r	c	t	v	t	i	m	i	s	g	p	a	t
h	j	u	d	e	j	i	l	e	r	p	n	o	z	a
w	f	s	x	n	x	o	e	s	r	r	m	o	o	c
a	s	h	a	v	i	n	g	f	o	a	m	c	r	d
s	s	p	o	n	g	e	h	b	r	y	z	x	k	r
h	d	e	n	t	a	l	f	l	o	s	s	l	a	j
w	w	r	v	d	s	u	n	s	c	r	e	e	n	s

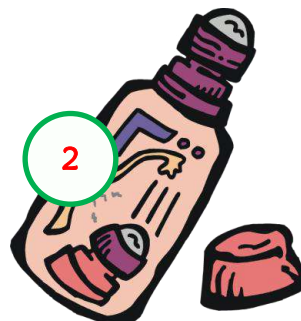
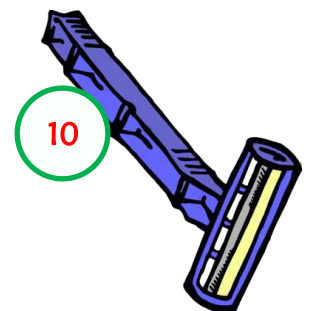
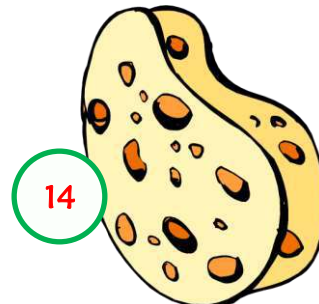
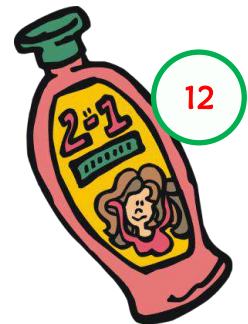
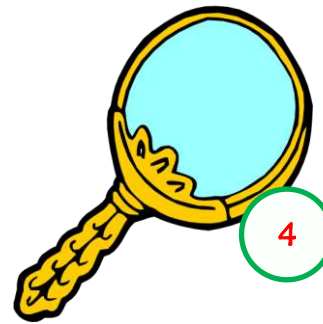
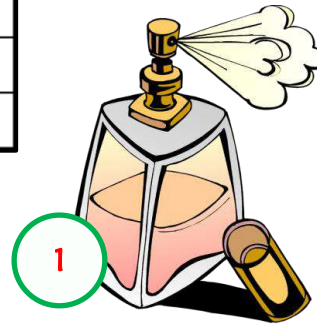

1. perfume
2. deodorant
3. hand lotion
4. mirror
5. mouthwash
6. dental floss
7. toothbrush
8. toothpaste
9. lip balm
10. razor
11. shaving foam
12. shampoo
13. shower gel
14. sponge
15. sunscreen
16. hair spray

PERSONAL CARE PRODUCTS WORD SEARCH PUZZLE 2 ANSWER KEY

Find and circle the words in the word search puzzle and number the pictures

k	u	c	o	t	t	o	n	b	u	d	c	a	g	u
m	x	s	h	a	i	r	b	r	u	s	h	o	o	u
n	k	u	t	i	s	s	u	e	s	s	s	w	u	w
a	t	n	u	w	j	e	t	f	s	x	g	k	c	s
i	p	g	f	b	q	e	w	m	v	h	h	f	l	c
l	a	l	a	h	h	n	e	y	d	a	d	u	v	i
f	p	a	c	c	a	p	e	t	x	i	w	e	d	s
i	e	s	i	k	i	u	z	b	n	r	o	o	s	s
l	r	s	a	i	r	a	e	v	s	d	o	x	x	o
e	t	e	l	e	c	t	r	i	c	r	a	z	o	r
u	o	s	m	z	l	c	s	k	w	y	q	d	e	s
z	w	b	a	z	i	o	z	g	m	e	g	y	x	w
c	e	e	s	g	p	m	h	a	i	r	b	a	n	d
u	l	x	k	m	s	b	i	k	s	c	a	l	e	s
e	n	a	i	l	c	l	i	p	p	e	r	s	n	w

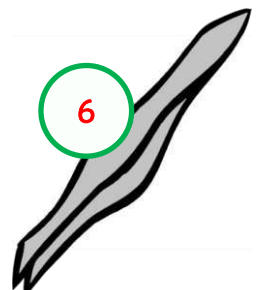
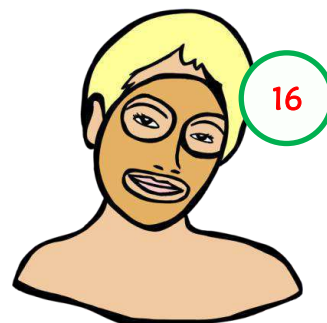
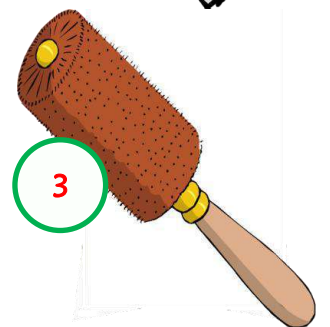
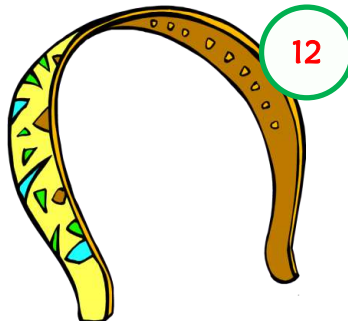
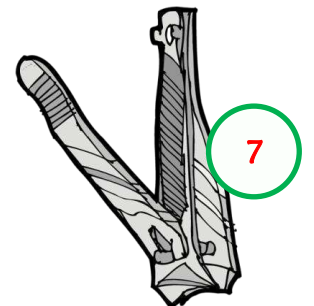
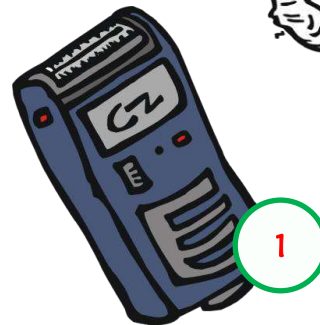
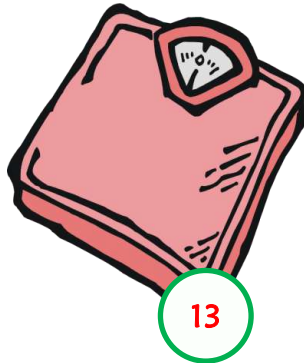
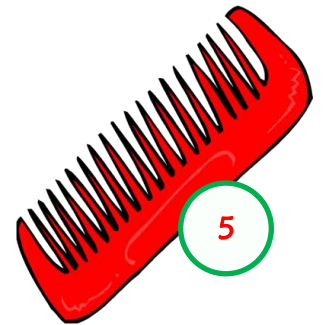
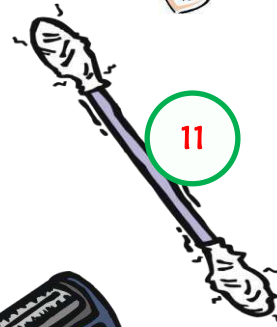
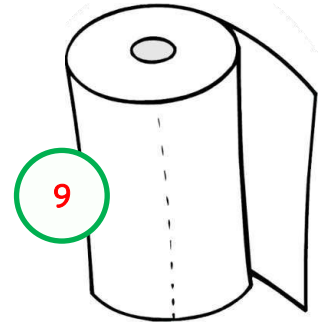
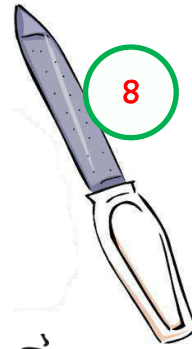
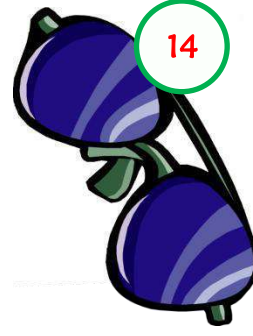

1. electric razor
2. hair dryer
3. hairbrush
4. scissors
5. comb
6. tweezers
7. nail clippers
8. nail file
9. paper towel
10. tissues
11. cotton bud
12. hairband
13. scales
14. sunglasses
15. hair clips
16. facial mask



PERSONAL CARE PRODUCTS CROSSWORD PUZZLE !

Look at the numbers on the pictures and write the personal care products vocabulary in the crossword puzzle

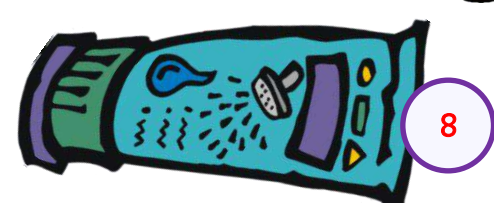
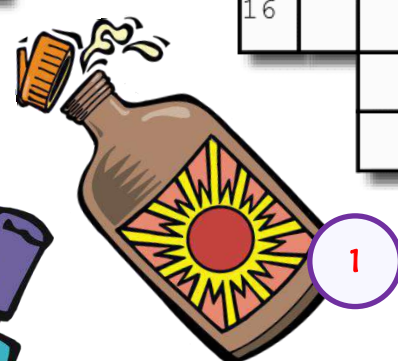
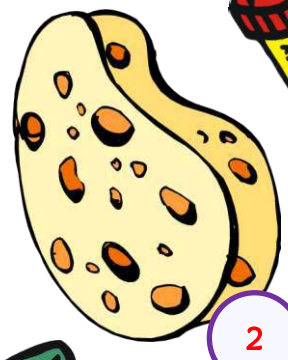
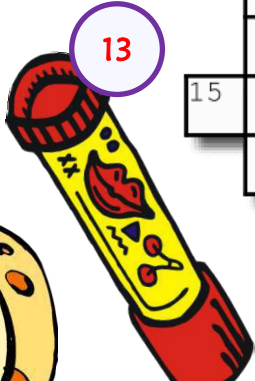
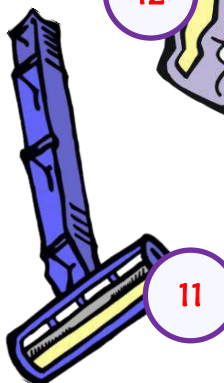
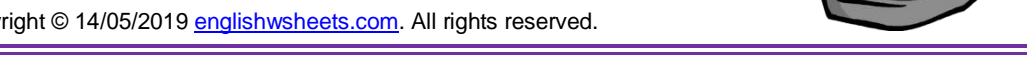
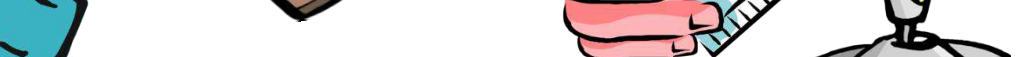
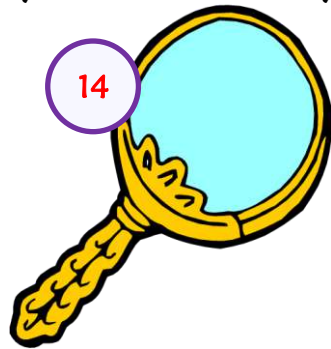

ANSWER KEY

Across

1. sunscreen
3. shampoo
5. toothpaste
8. shower gel
10. mouthwash
11. razor
12. dental floss
13. lip balm
15. hand lotion
16. perfume

Down

2. sponge
4. hair spray
6. toothbrush
7. deodorant
9. shaving foam
14. mirror

PERSONAL CARE PRODUCTS CROSSWORD PUZZLE 2

Look at the numbers on the pictures and write the personal care products vocabulary in the crossword puzzle

15

13

14

3

4

1

2

3

5

6

7

8

1

7

6

9

9

11

13

12

14

10

15

16

12

4

8

5

16

2

10

11

9

6

1

3

4

5

6

7

8

9

10

11

12

13

14

15

16

ANSWER KEY

Across

- 2. tissues
- 8. nail clippers
- 13. hairband
- 14. scales
- 15. hair dryer
- 16. sunglasses

Down

- 1. nail file
- 3. scissors
- 4. facial mask
- 5. paper towel
- 6. tweezers
- 7. electric razor
- 9. comb
- 10. hairbrush
- 11. hair clips
- 12. cotton bud

PERSONAL CARE PRODUCTS MISSING LETTERS IN WORDS !

Write the missing letters in the boxes to complete the personal care products vocabulary



h_nd l_t__n

p_rf_m_



d__d_r_nt



m_rr_r



m__thw_sh

d_nt_l fl_ss

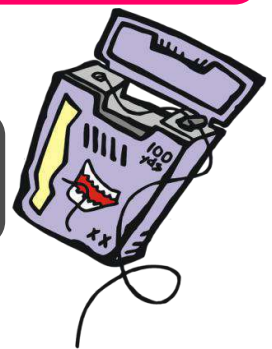

sh_mp__



t__thbr_sh



t__thp_st_

l_p b_lm

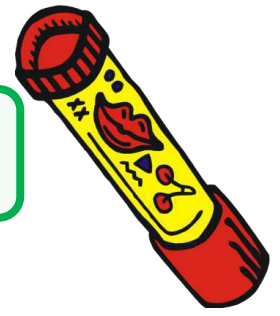

sh_v_ng f__m

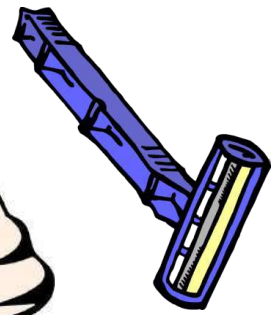

r_z_r



sh_w_r g_l

s_nscr__n



sp_ng_

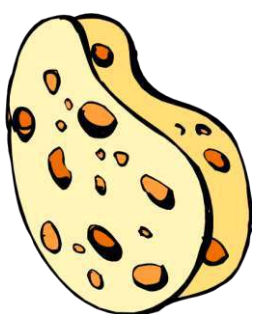

h__r spr_y

PERSONAL CARE PRODUCTS MISSING LETTERS IN WORDS 2

Write the missing letters in the boxes to complete the personal care products vocabulary

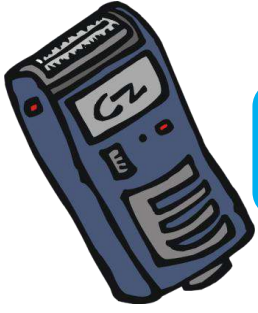

_l_ctr_c_r_z_r

c_mb



h__rbr_sh

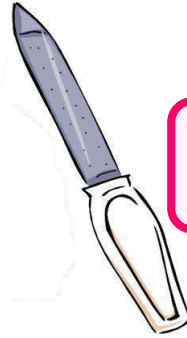

n__l_f_l_

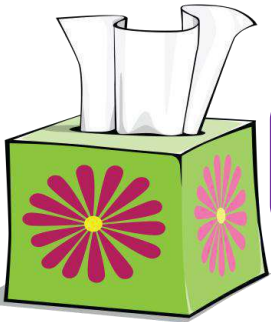

t_ss__s

h__r_dry_r



tw__z_rs

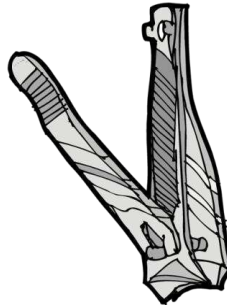

n__l_cl_pp_rs

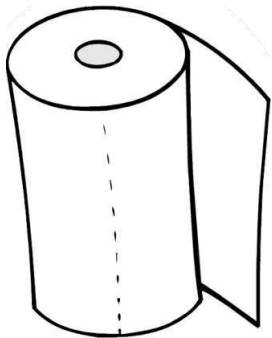

p_p_r_t_w_l

sc_l_s

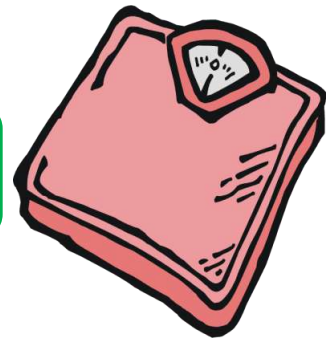

sc_ss_rs

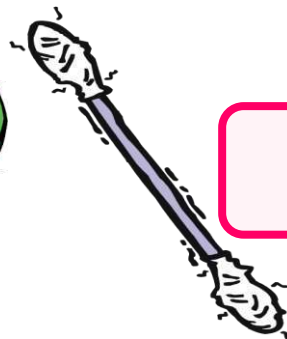

c_tt_n_b_d

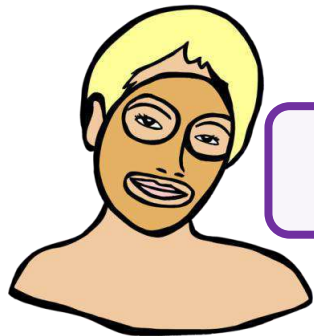

f_c__l_m_sk

s_ngl_ss_s



h__db_nd

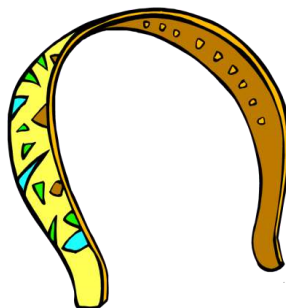

h__r_cl_ps

PERSONAL CARE PRODUCTS MISSING LETTERS IN WORDS | ANSWER KEY

Write the missing letters in the boxes to complete the personal care products vocabulary



hand lotion



perfume



deodorant



mirror



mouthwash



dental floss



shampo



toothbrush



toothpaste



lip balm

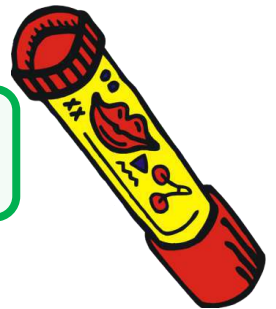

shaving foam

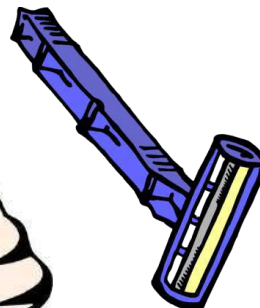

razor



shower gel



sunscreen



sponge

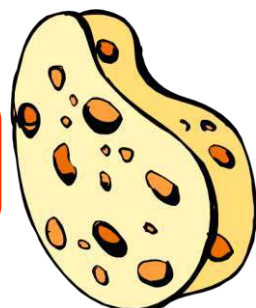

hair spray

PERSONAL CARE PRODUCTS MISSING LETTERS IN WORDS 2 ANSWER KEY

Write the missing letters in the boxes to complete the personal care products vocabulary



electric razor

comb



hairbrush



nail file

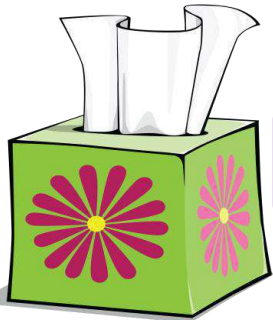
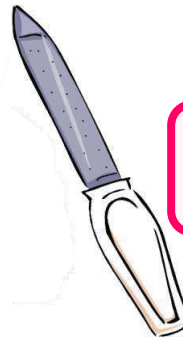

tissues

hair dryer



tweezers



nail clippers

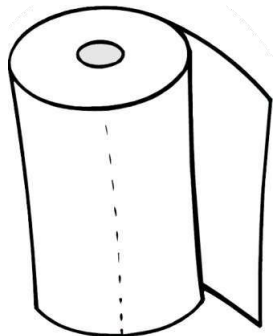
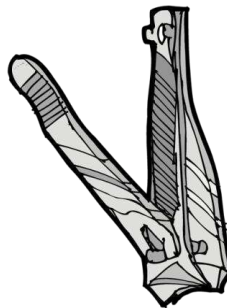

paper towel

scales

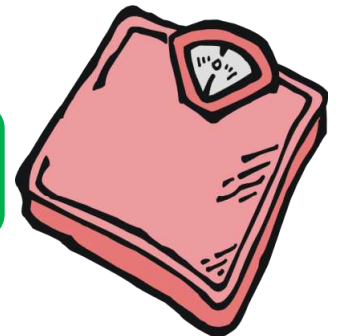

scissors



cotton bud

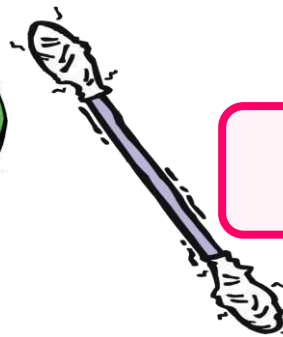

facial mask

sunglasses

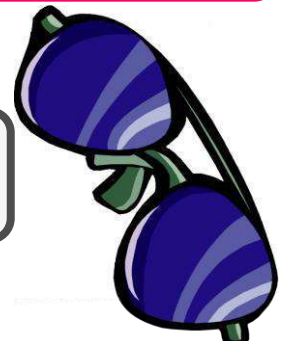
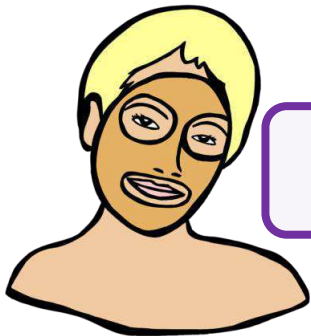

headband

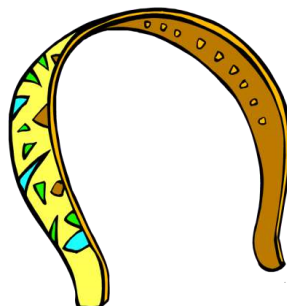

hair clips



PERSONAL CARE PRODUCTS UNSCRAMBLE THE WORDS !

Unscramble the personal care products vocabulary and number the pictures

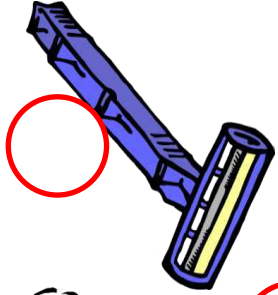

1. emrfuep

2. eotdnorad

3. ahdn nlooti

4. miorrr

5. hhuwtamso

6. tdaeln slsfo

7. rthuohsbt

8. stottaepho

9. pli bmal

10. zaror

11. ihasvgn amfo

12. hapmoos

13. eohwsr egl

14. engspo

15. sncseun

16. rhia ysarp

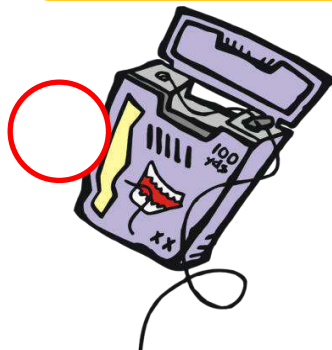
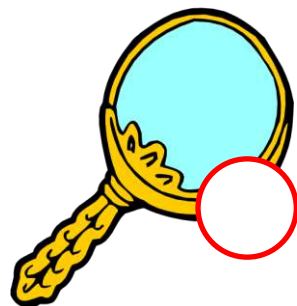
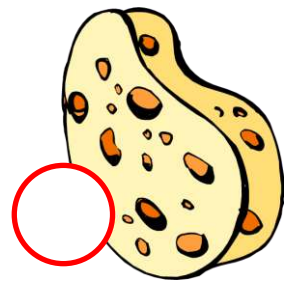

PERSONAL CARE PRODUCTS UNSCRAMBLE THE WORDS 2

Unscramble the personal care products vocabulary and number the pictures

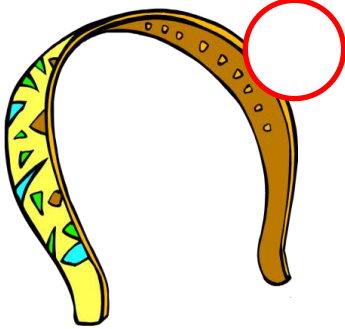
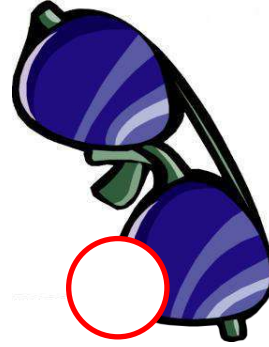
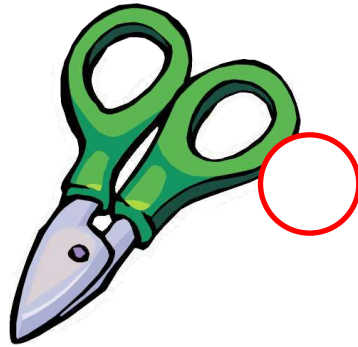
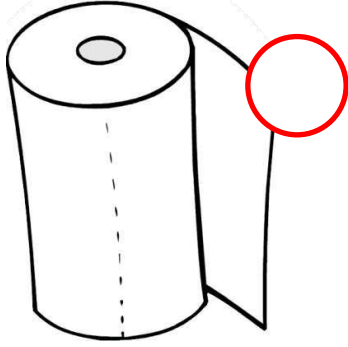

1. celercit zrrao _____
2. arih ryerd _____
3. urasihbhr _____
4. roscsis _____
5. bcmo _____
6. serzetew _____
7. Inia rplecpis _____
8. anil lfei _____
9. rpaep tlweo _____
10. estsuis _____
11. ottonc ubd _____
12. ahnibrad _____
13. scleas _____
14. uaeslnssg _____
15. ahir pcsil _____
16. fciala aksm _____

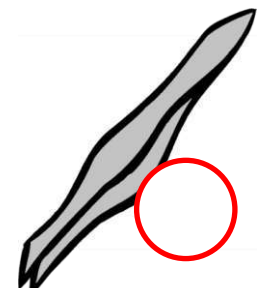
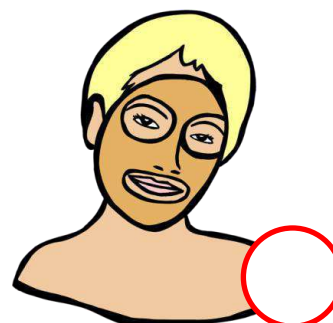
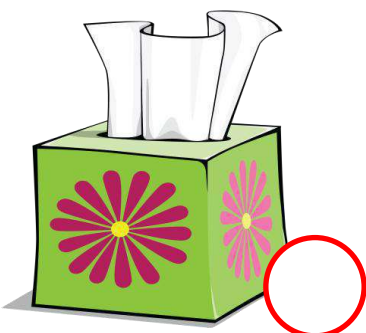
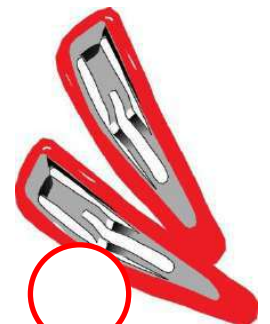
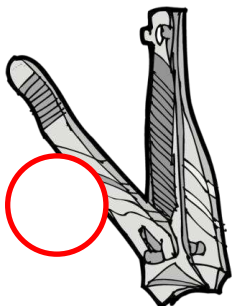
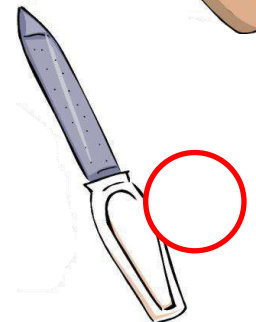
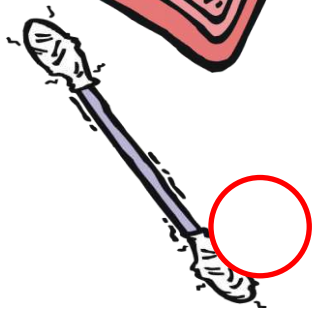
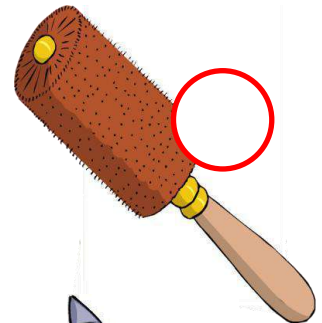
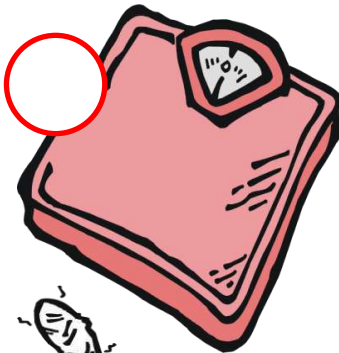
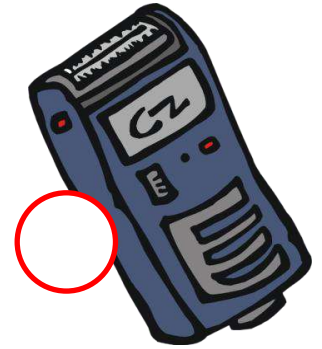

PERSONAL CARE PRODUCTS UNSCRAMBLE THE WORDS | ANSWER KEY

Unscramble the personal care products vocabulary and number the pictures

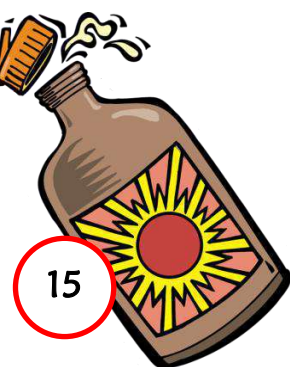
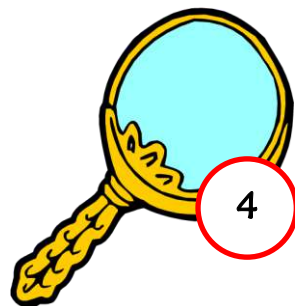
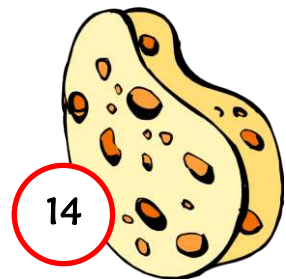
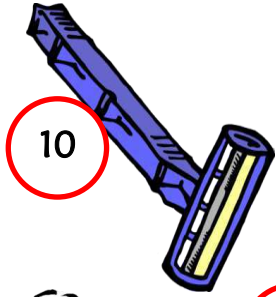
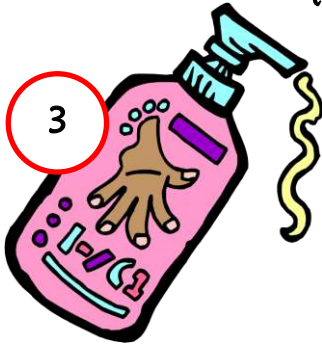

- | | |
|------------------|--------------|
| 1. emrfuep | perfume |
| 2. eotdnorad | deodorant |
| 3. ahdn nlooti | hand lotion |
| 4. miorrr | mirror |
| 5. hhuwtamso | mouthwash |
| 6. tdaeln slsfo | dental floss |
| 7. rthuohsbt | toothbrush |
| 8. stottaepho | toothpaste |
| 9. pli bmal | lip balm |
| 10. zaror | razor |
| 11. ihasvgn amfo | shaving foam |
| 12. hapmoos | shampoo |
| 13. eohwsr egl | shower gel |
| 14. engspo | sponge |
| 15. sncseun | sunscreen |
| 16. rhia ysarp | hair spray |

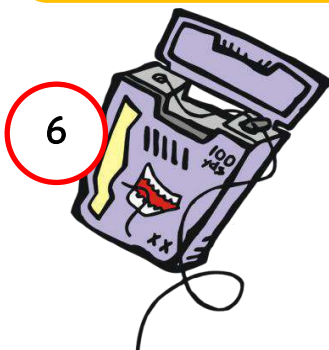

PERSONAL CARE PRODUCTS UNSCRAMBLE THE WORDS 2 ANSWER KEY

Unscramble the personal care products vocabulary and number the pictures

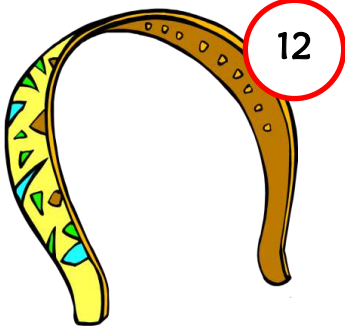
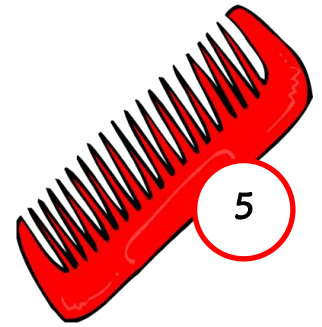
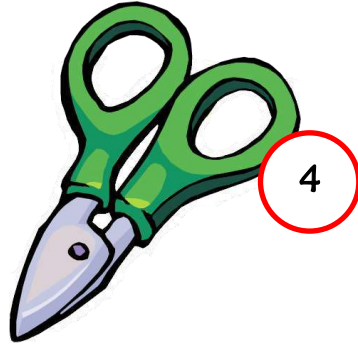
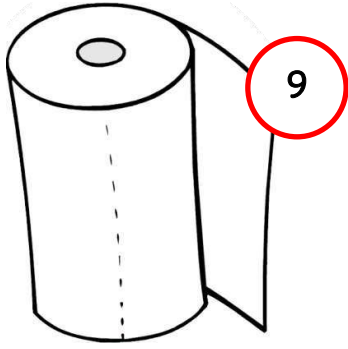

- | | |
|-------------------|----------------|
| 1. celercit zrrao | electric razor |
| 2. arih ryerd | hair dryer |
| 3. urasihbhr | hairbrush |
| 4. roscsis | scissors |
| 5. bcmo | comb |
| 6. serzetew | tweezers |
| 7. Inia rplecpis | nail clippers |
| 8. anil lfei | nail file |
| 9. rpaep tlweo | paper towel |
| 10. estsuis | tissues |
| 11. ottonc ubd | cotton bud |
| 12. ahnibrad | hairband |
| 13. scleas | scales |
| 14. uaeslnssg | sunglasses |
| 15. ahir pcsil | hair clips |
| 16. fciala aksm | facial mask |

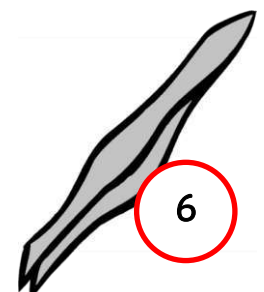
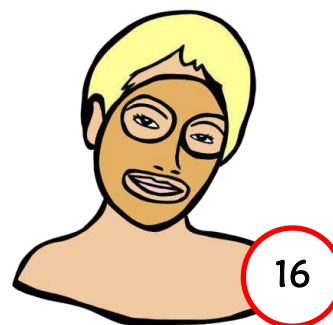
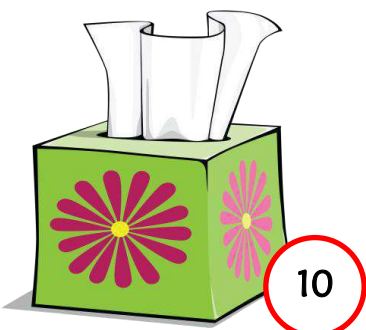
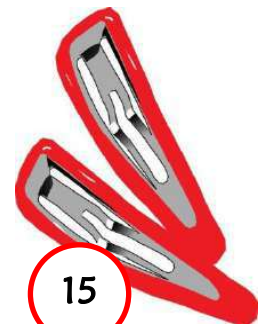
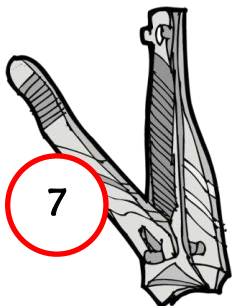
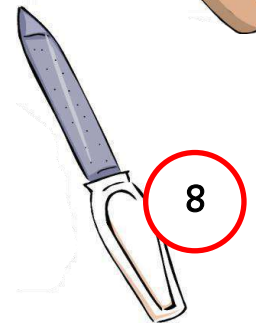
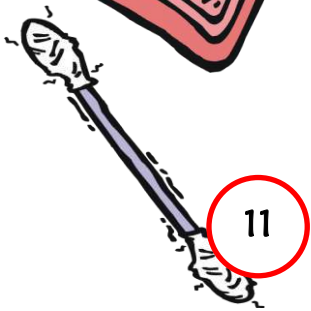
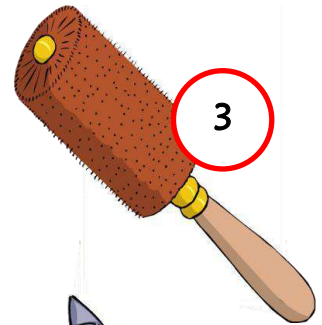
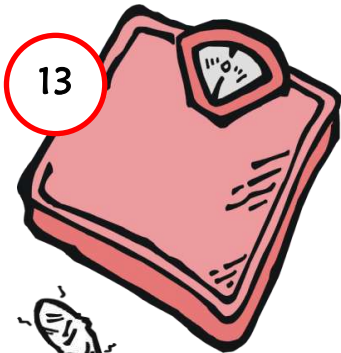

PERSONAL CARE PRODUCTS MULTIPLE CHOICE TEST 1

Look at the pictures, choose and circle the correct option.



- a) shaving foam
- b) toothpaste
- c) perfume
- d) sponge



- a) deodorant
- b) lip balm
- c) hair spray
- d) toothbrush



- a) mouthwash
- b) shampoo
- c) hand lotion
- d) shower gel

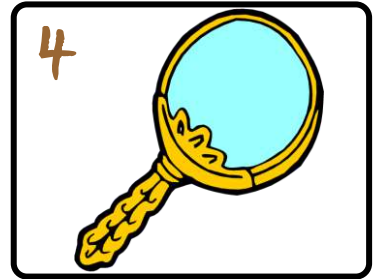

- a) razor
- b) sunscreen
- c) dental floss
- d) mirror



- a) hand lotion
- b) mouthwash
- c) shampoo
- d) hair spray

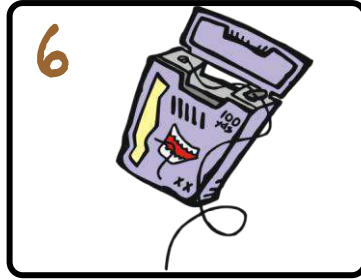

- a) dental floss
- b) mirror
- c) shower gel
- d) shaving foam



- a) perfume
- b) toothbrush
- c) razor
- d) sunscreen



- a) toothpaste
- b) lip balm
- c) deodorant
- d) sponge

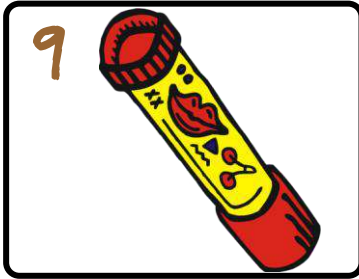

- a) sunscreen
- b) dental floss
- c) mirror
- d) lip balm

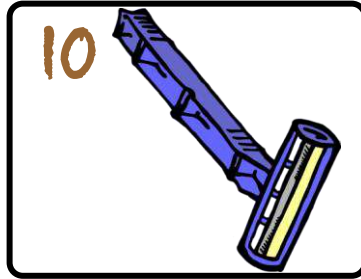

- a) hair spray
- b) perfume
- c) toothpaste
- d) razor



- a) shower gel
- b) deodorant
- c) shaving foam
- d) toothbrush



- a) shampoo
- b) hand lotion
- c) sponge
- d) mouthwash



- a) shaving foam
- b) shower gel
- c) toothbrush
- d) deodorant

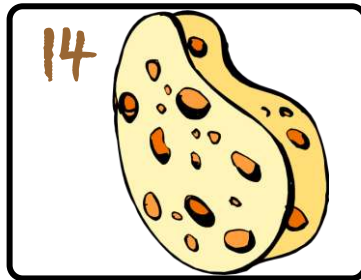

- a) lip balm
- b) toothbrush
- c) sponge
- d) mirror



- a) azor
- b) sunscreen
- c) mouthwash
- d) perfume



- a) hand lotion
- b) hair spray
- c) shampoo
- d) toothpaste

PERSONAL CARE PRODUCTS MULTIPLE CHOICE TEST 2

Look at the pictures, choose and circle the correct option.

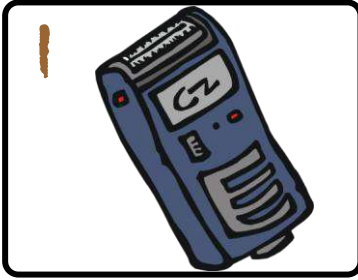

- a) nail clippers
- b) tissues
- c) facial mask
- d) electric razor



- a) nail file
- b) cotton bud
- c) hair dryer
- d) scales

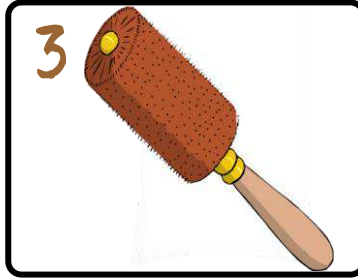

- a) sunglasses
- b) tweezers
- c) hairbrush
- d) paper towel

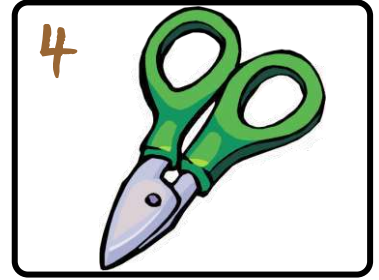

- a) hairband
- b) scissors
- c) hair clips
- d) comb



- a) hairbrush
- b) comb
- c) scales
- d) hairband

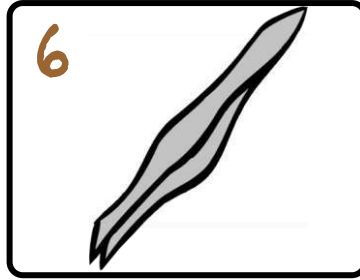

- a) paper towel
- b) facial mask
- c) scissors
- d) tweezers

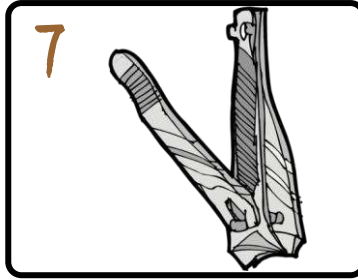

- a) hair dryer
- b) tissues
- c) nail clippers
- d) sunglasses

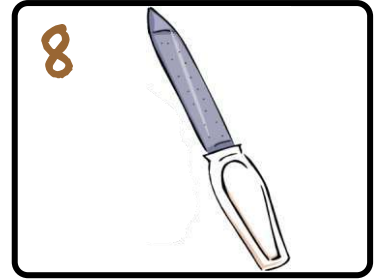

- a) cotton bud
- b) electric razor
- c) nail file
- d) hair clips

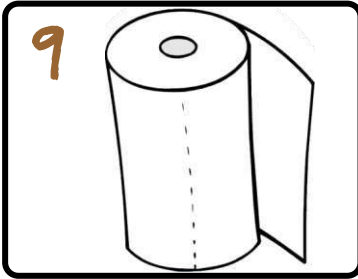

- a) hair dryer
- b) paper towel
- c) facial mask
- d) nail file

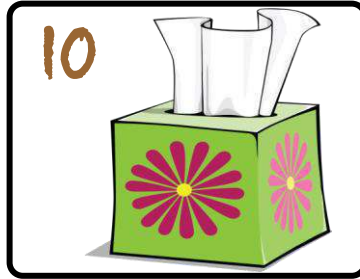

- a) hair clips
- b) nail clippers
- c) tissues
- d) hairbrush

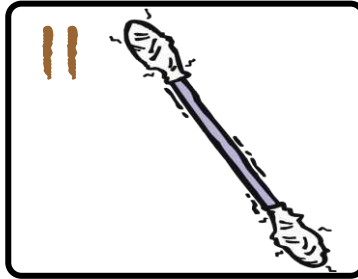

- a) comb
- b) electric razor
- c) hair dryer
- d) cotton bud

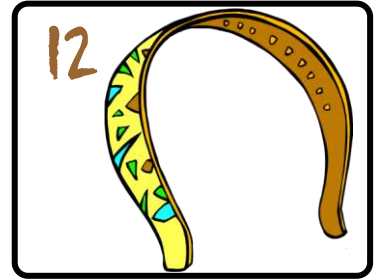

- a) scales
- b) hairband
- c) tweezers
- d) hairbrush

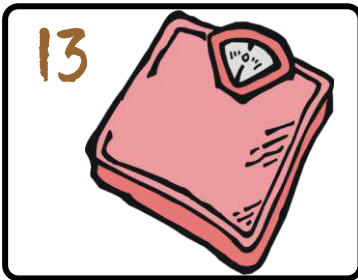

- a) tweezers
- b) scales
- c) cotton bud
- d) scissors

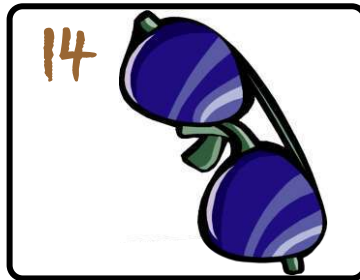

- a) nail file
- b) hairband
- c) sunglasses
- d) electric razor



- a) paper towel
- b) comb
- c) hairbrush
- d) hair clips

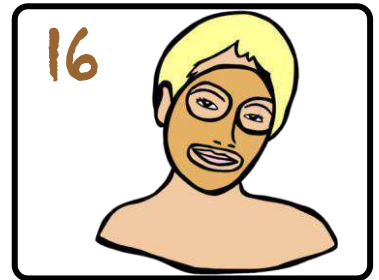

- a) nail clippers
- b) hair dryer
- c) tissues
- d) facial mask

PERSONAL CARE PRODUCTS MULTIPLE CHOICE TESTS ANSWER KEY

TEST 1

- 1) c
- 2) a
- 3) c
- 4) d
- 5) b
- 6) a
- 7) b
- 8) a
- 9) d
- 10) d
- 11) c
- 12) a
- 13) b
- 14) c
- 15) b
- 16) b

TEST 2

- 1) d
- 2) c
- 3) c
- 4) b
- 5) b
- 6) d
- 7) c
- 8) c
- 9) b
- 10) c
- 11) d
- 12) b
- 13) b
- 14) c
- 15) d
- 16) d



perfume



deodorant



hand lotion



mirror



mouthwash



dental floss



toothbrush



toothpaste



lip balm

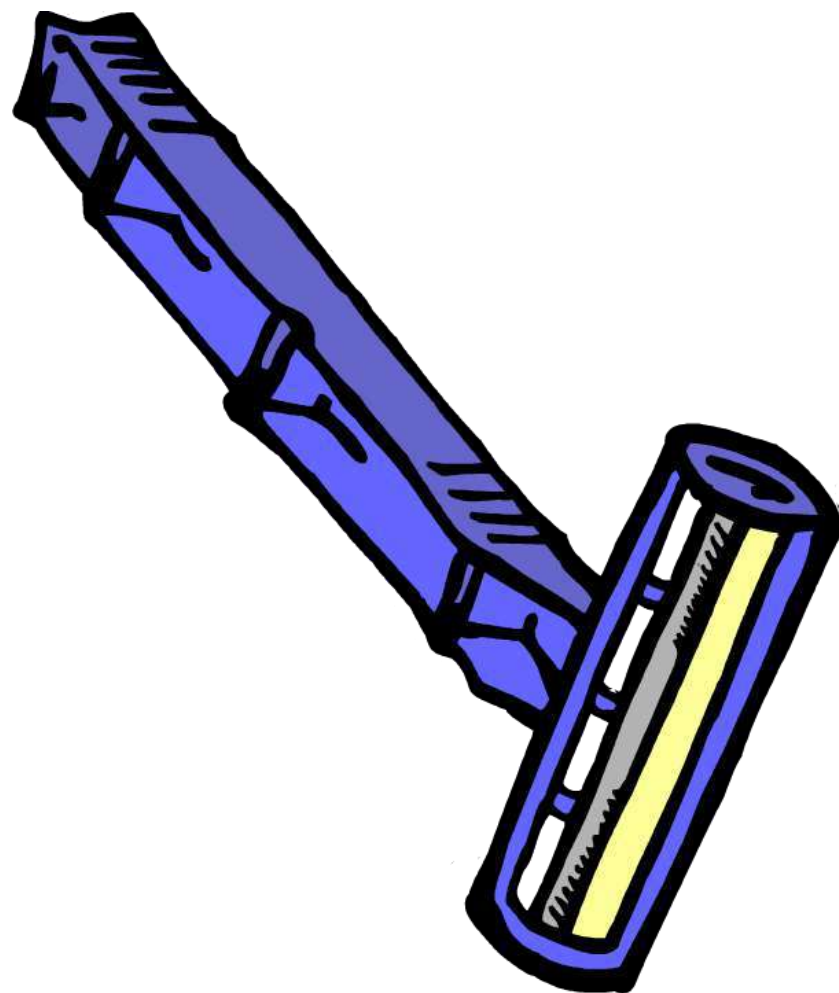

razor



shaving foam



shampoo



shower gel

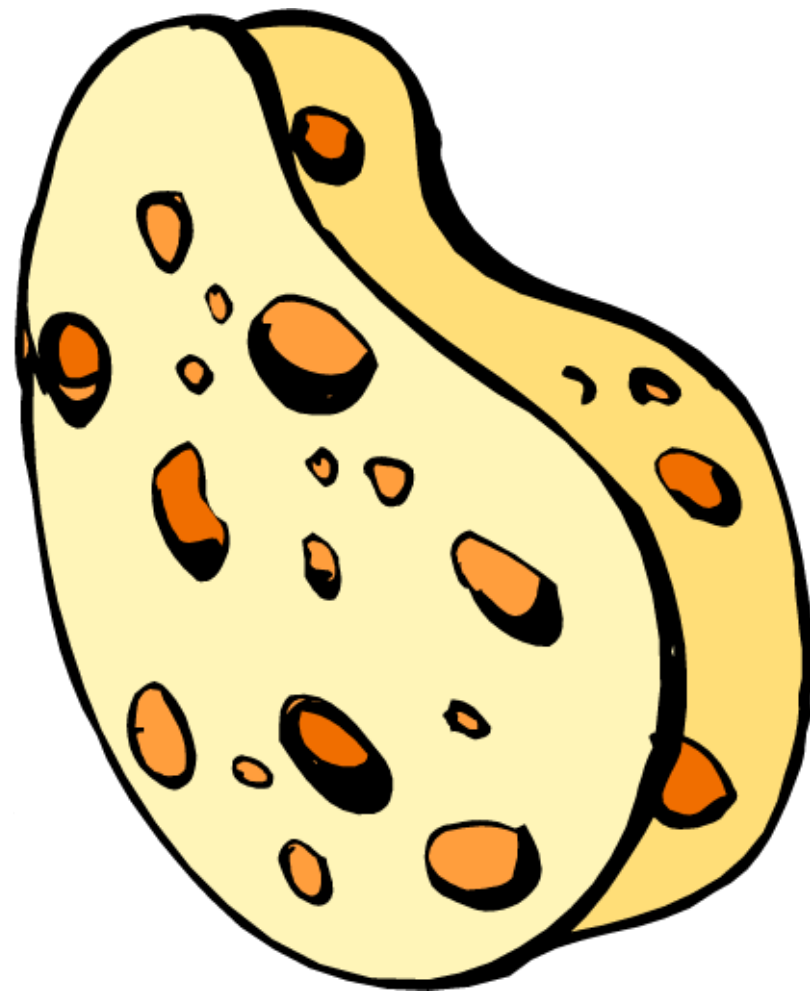

sponge



sunscreen



hair spray



electric razor



hair dryer

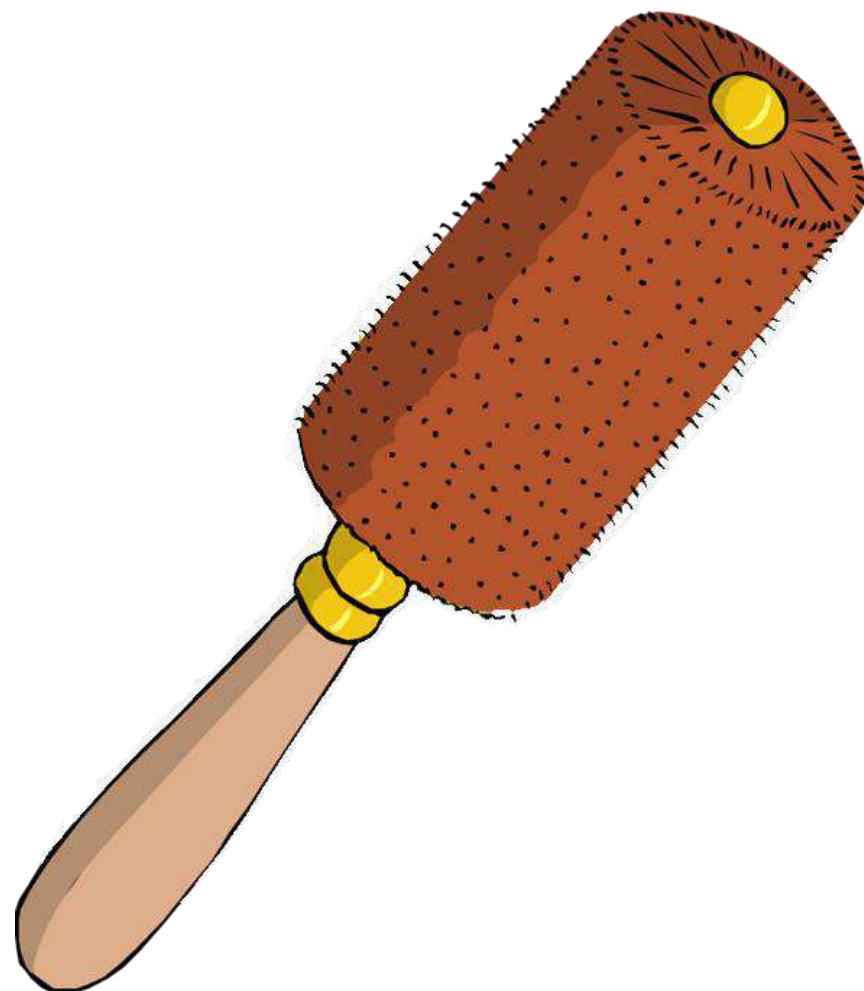

hairbrush



scissors



comb

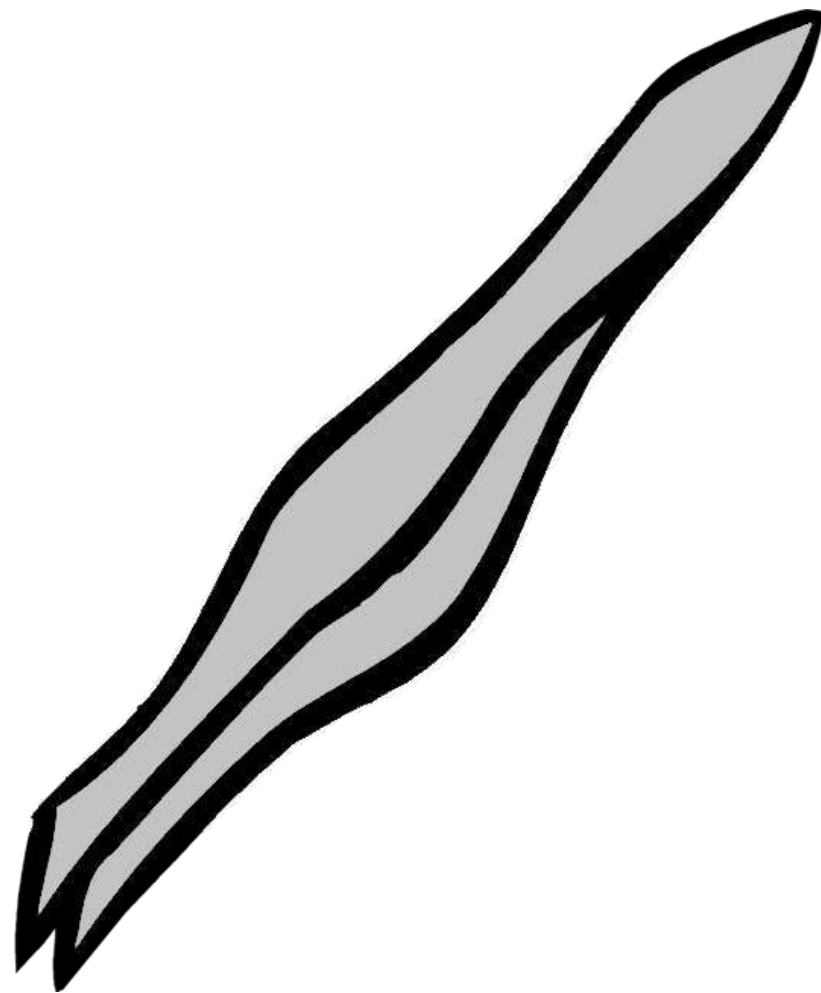

tweezers

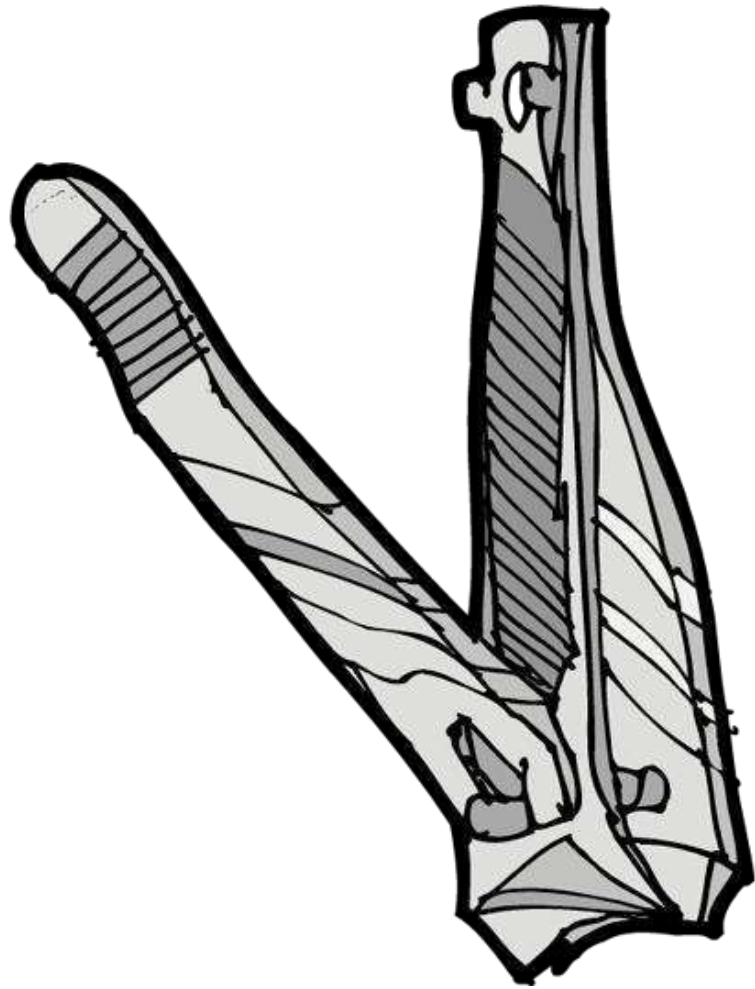

nail clippers

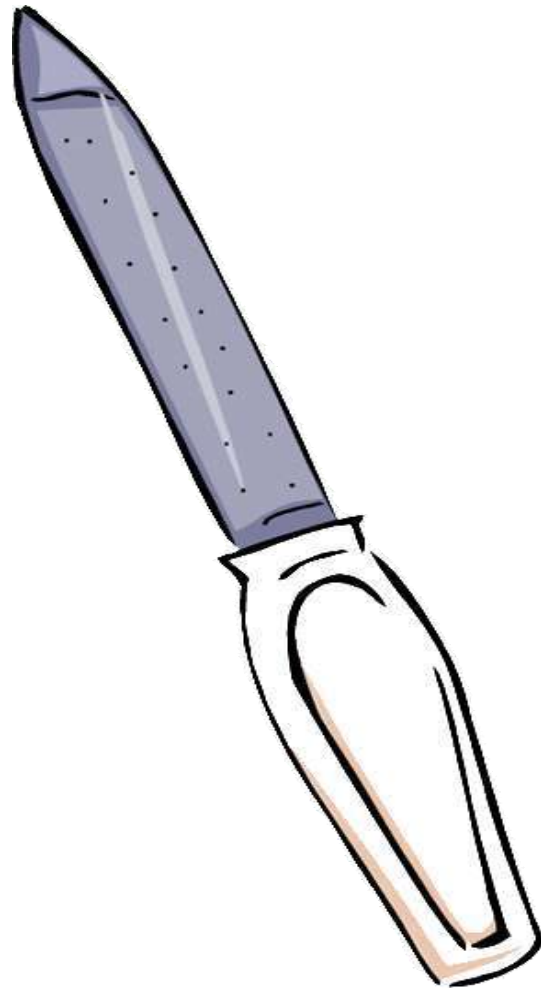

nail file

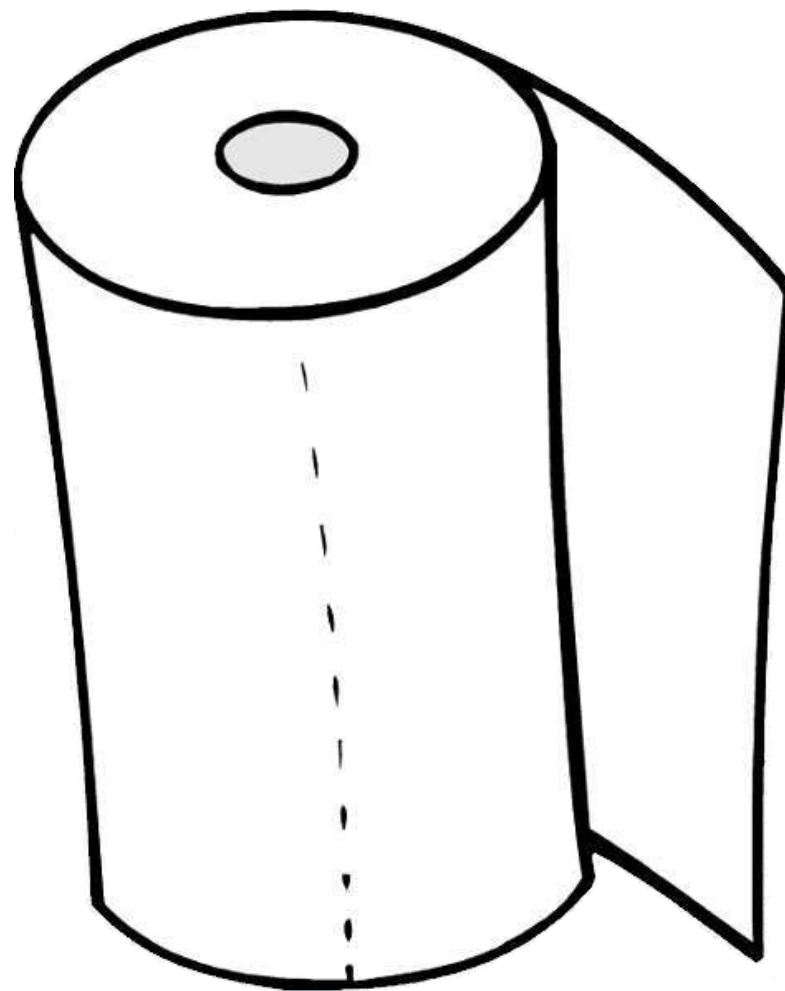

paper towel

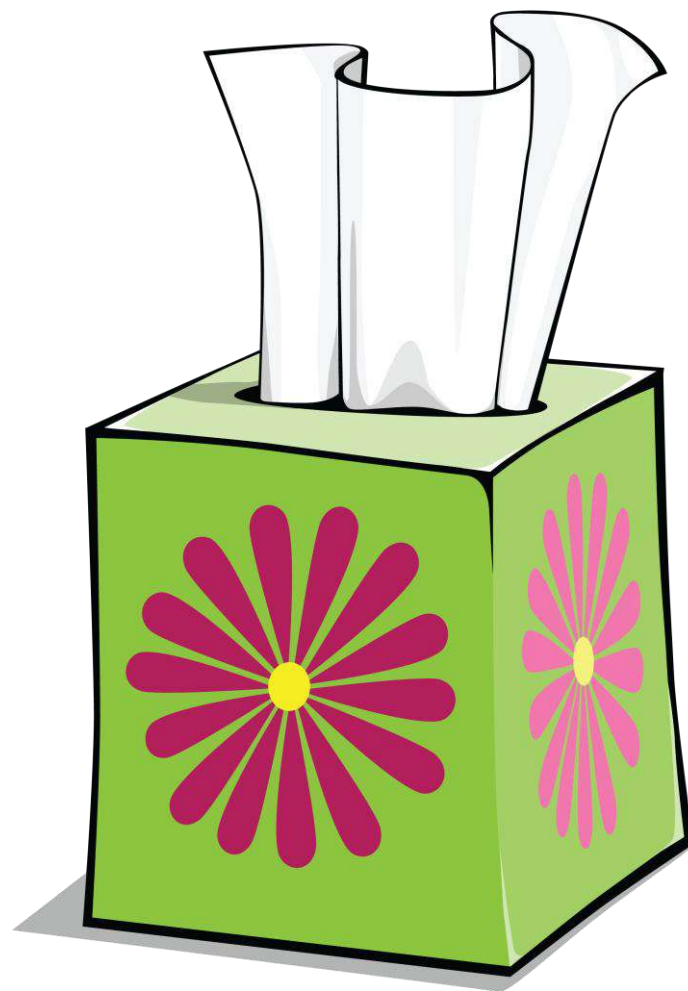

tissues

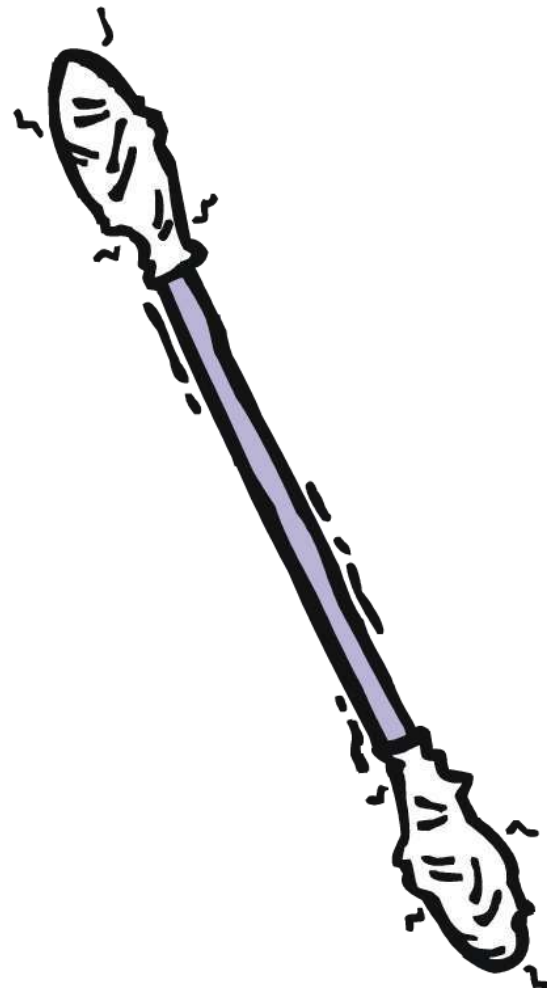

cotton bud

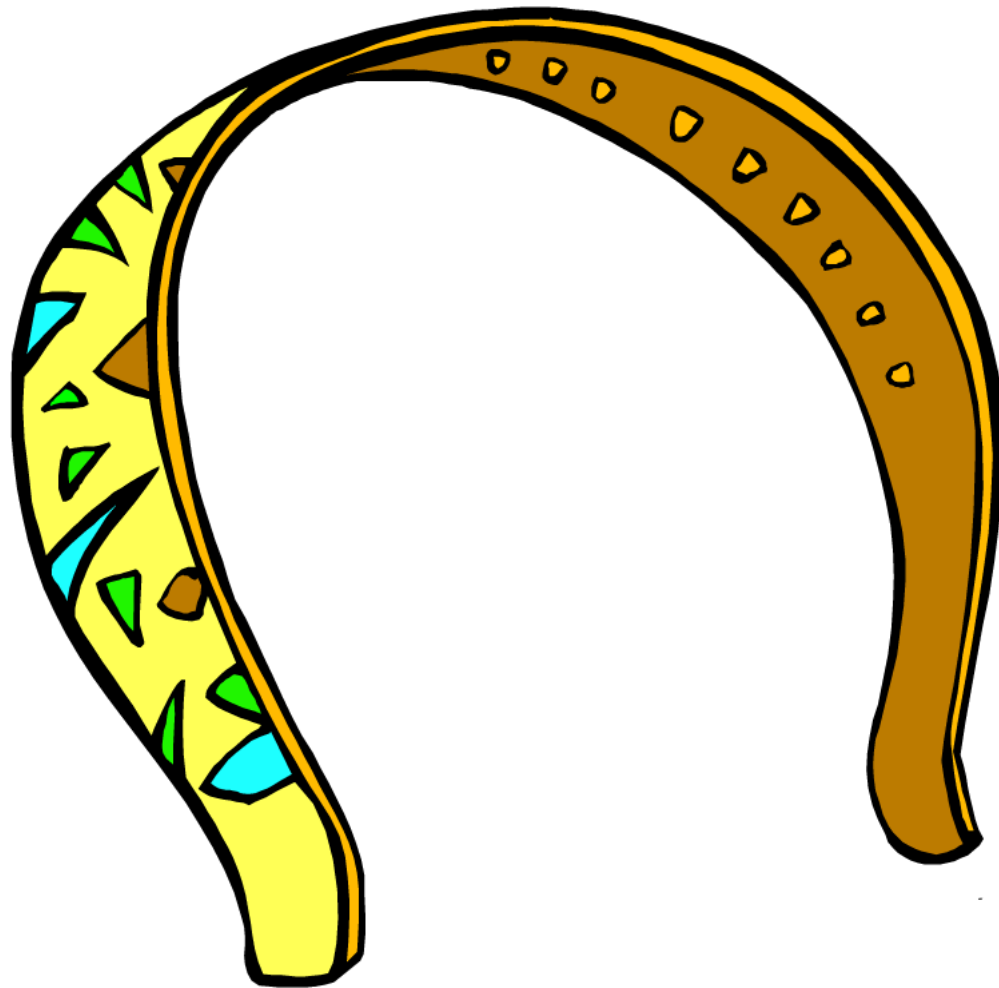

hairband

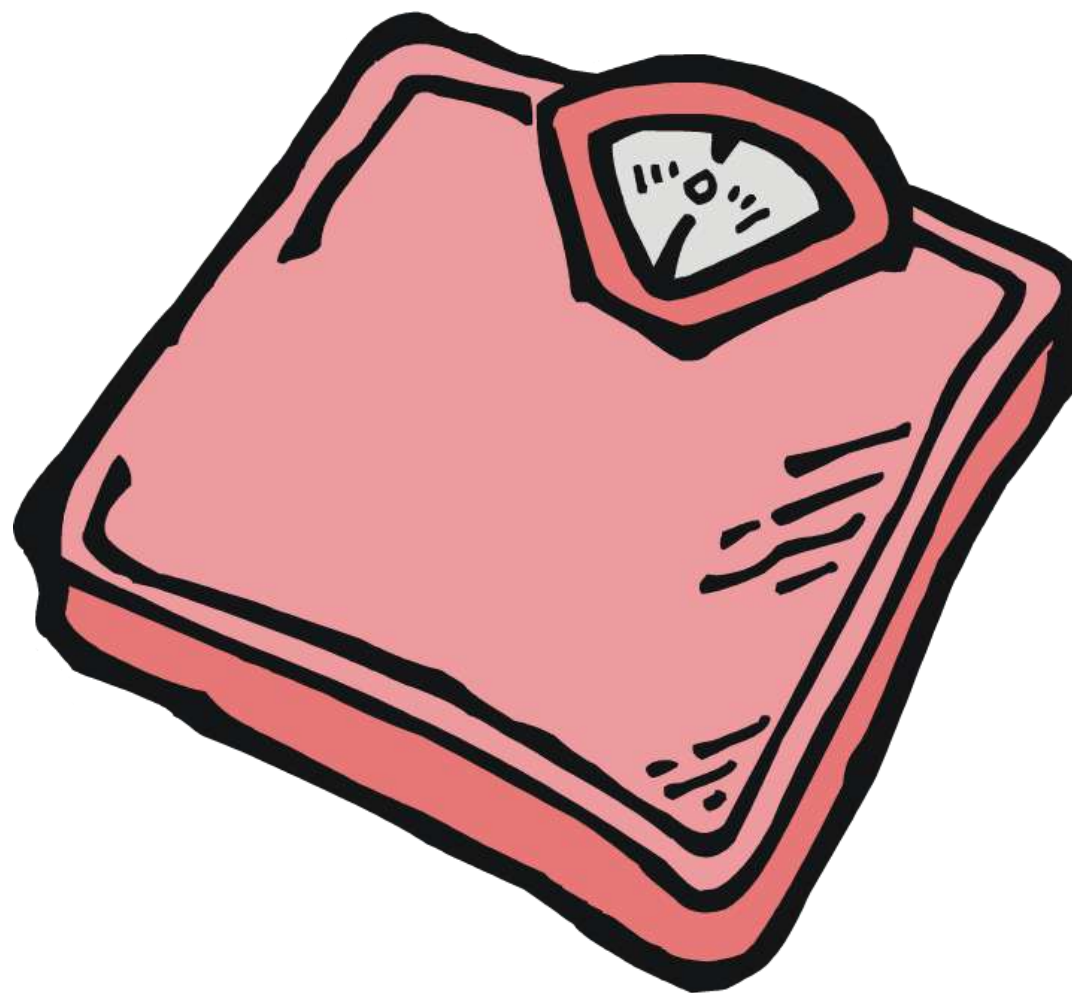

scales



sunglasses

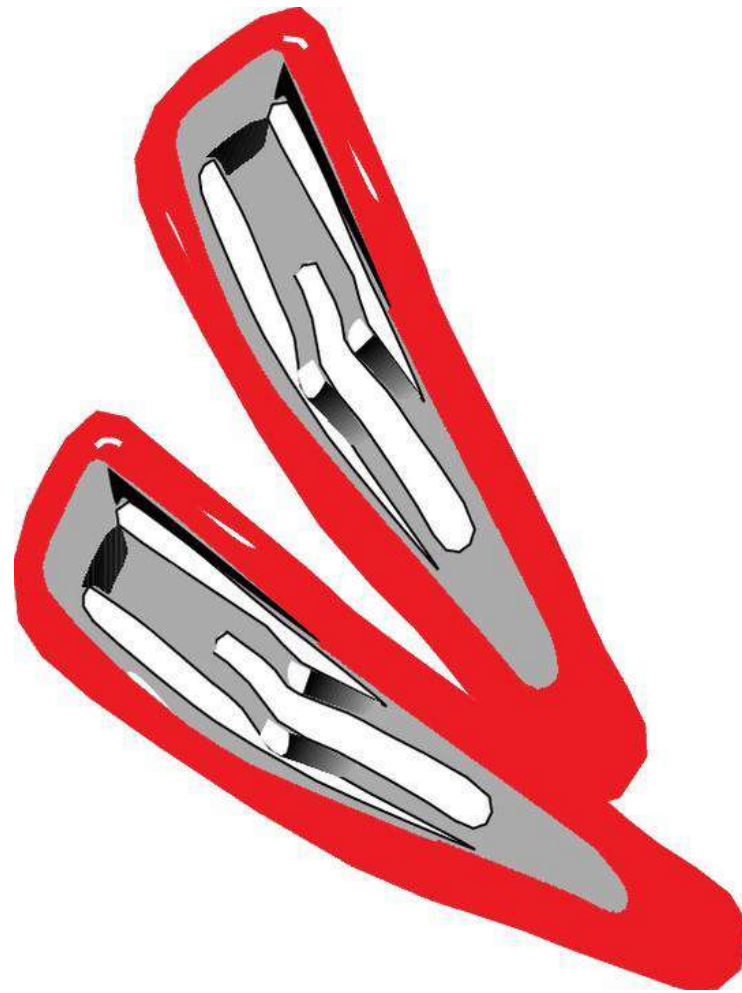

hair clips

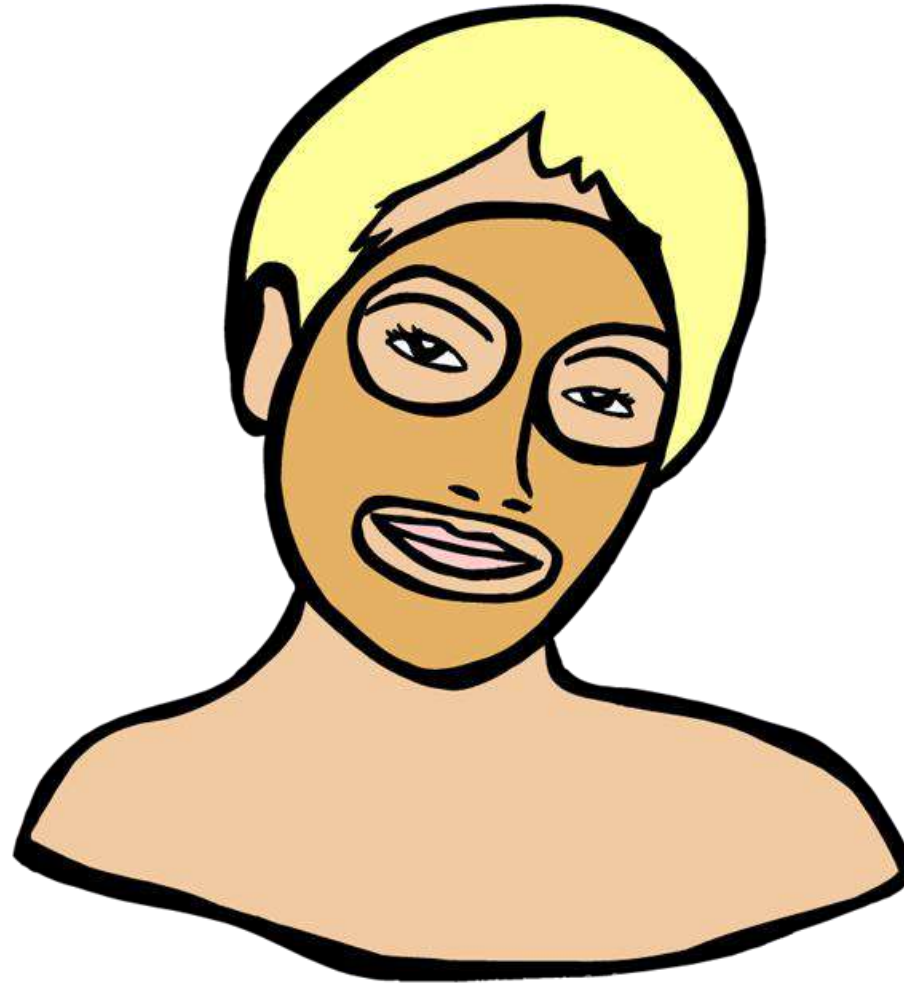

facial mask



















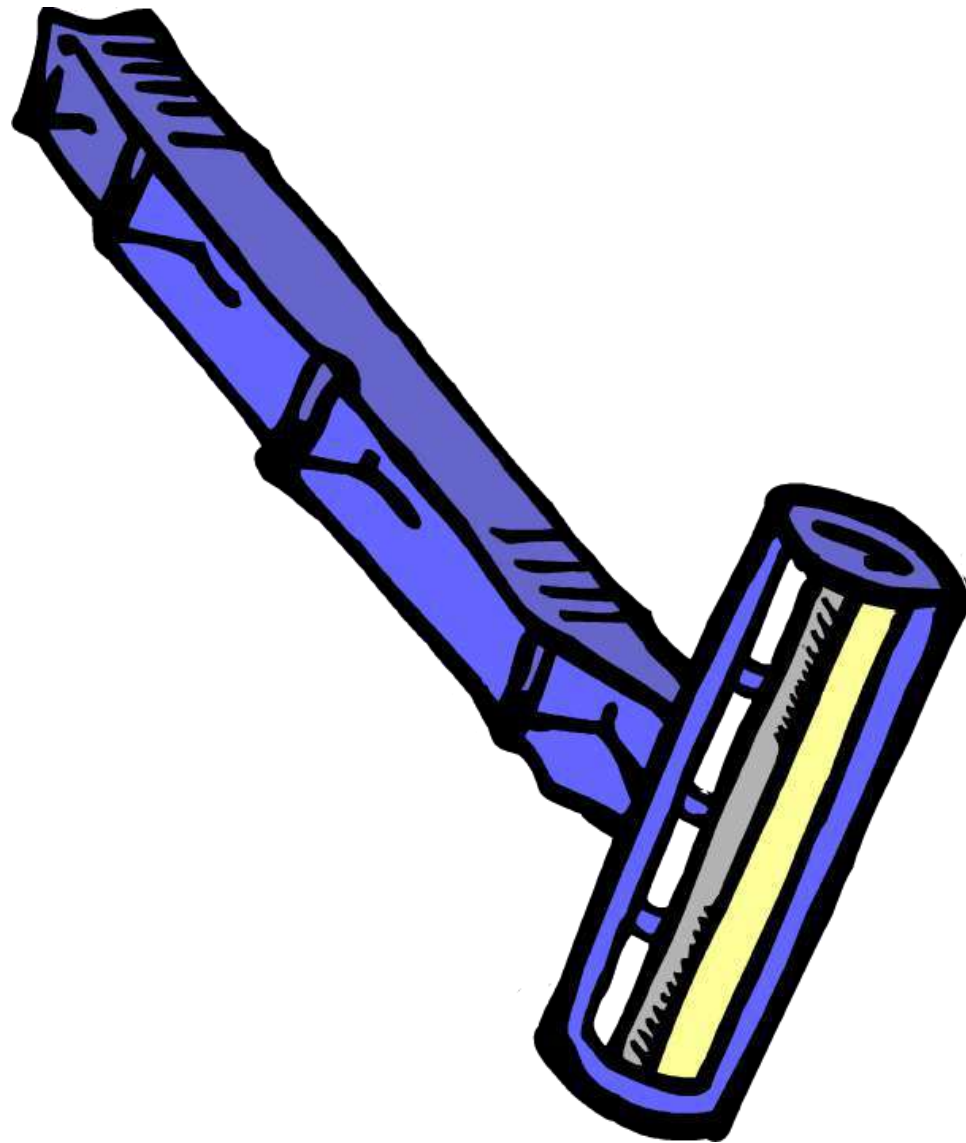







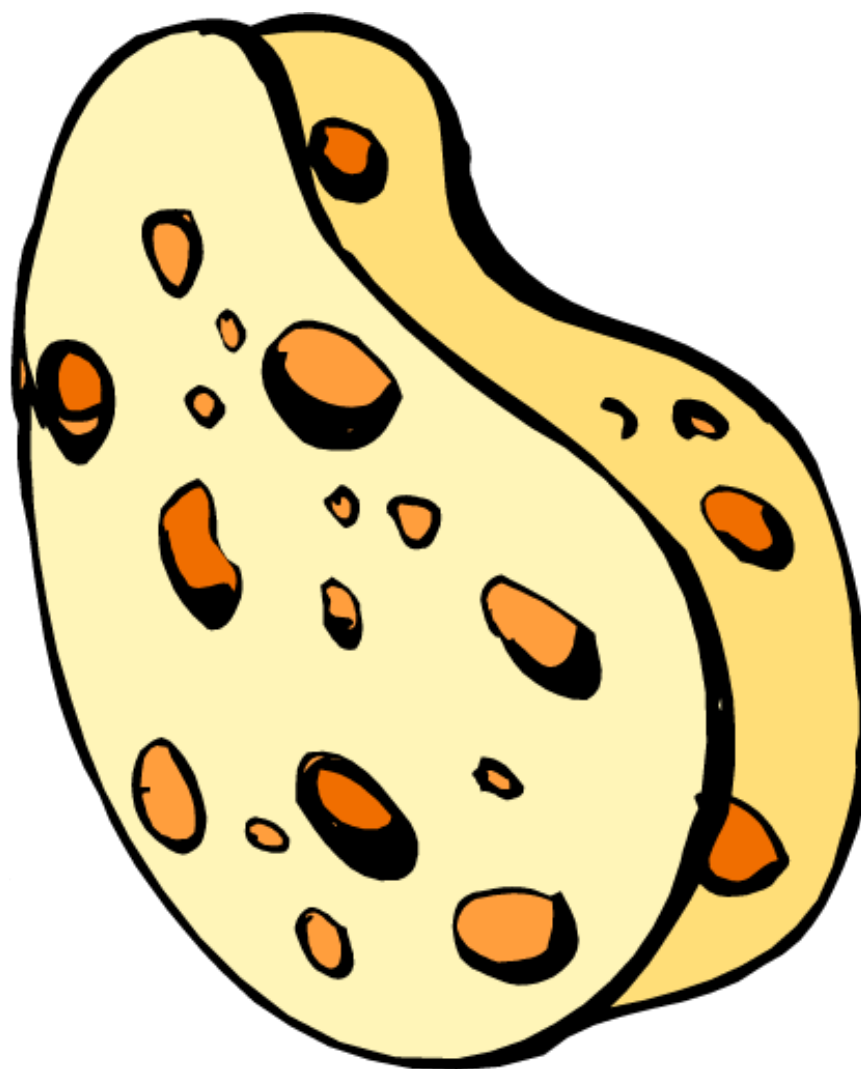









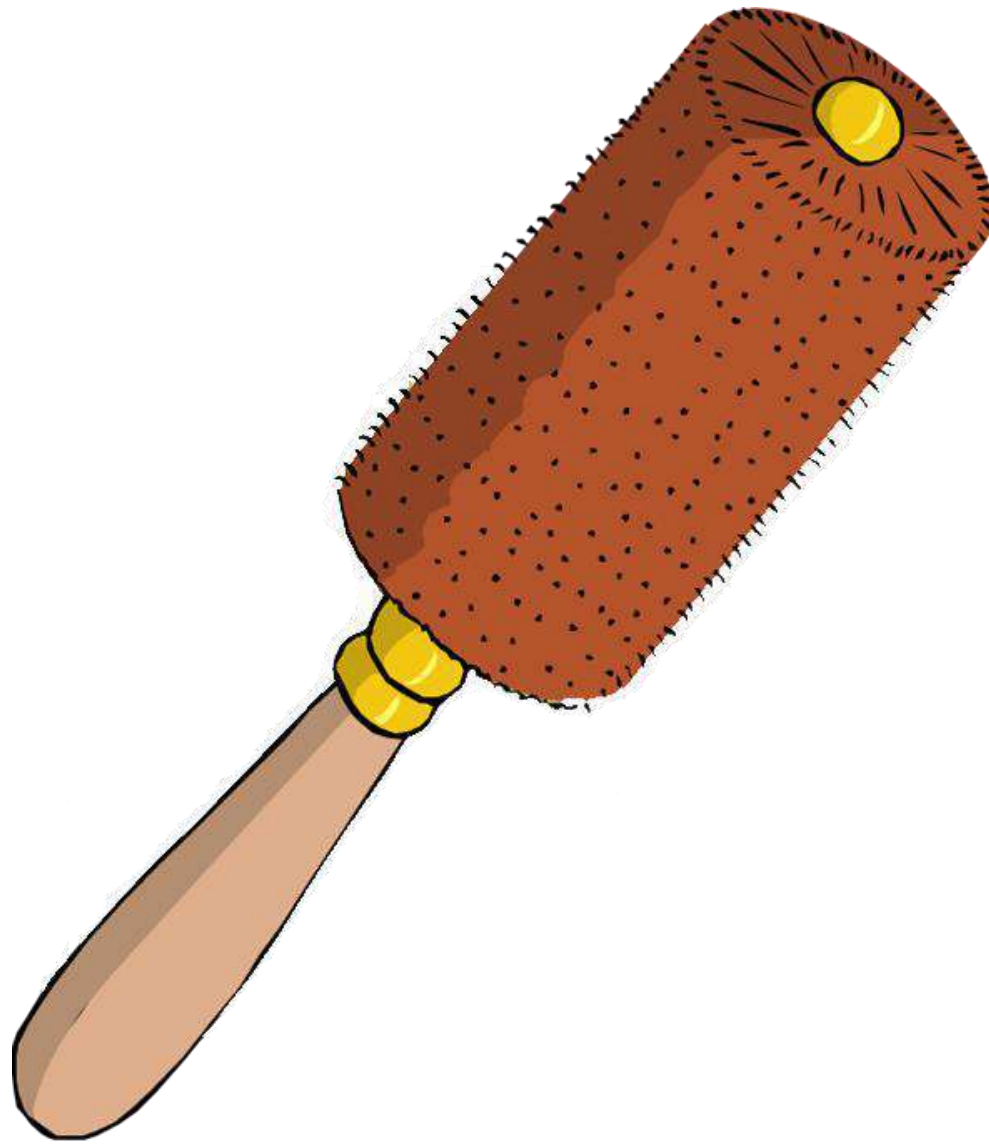





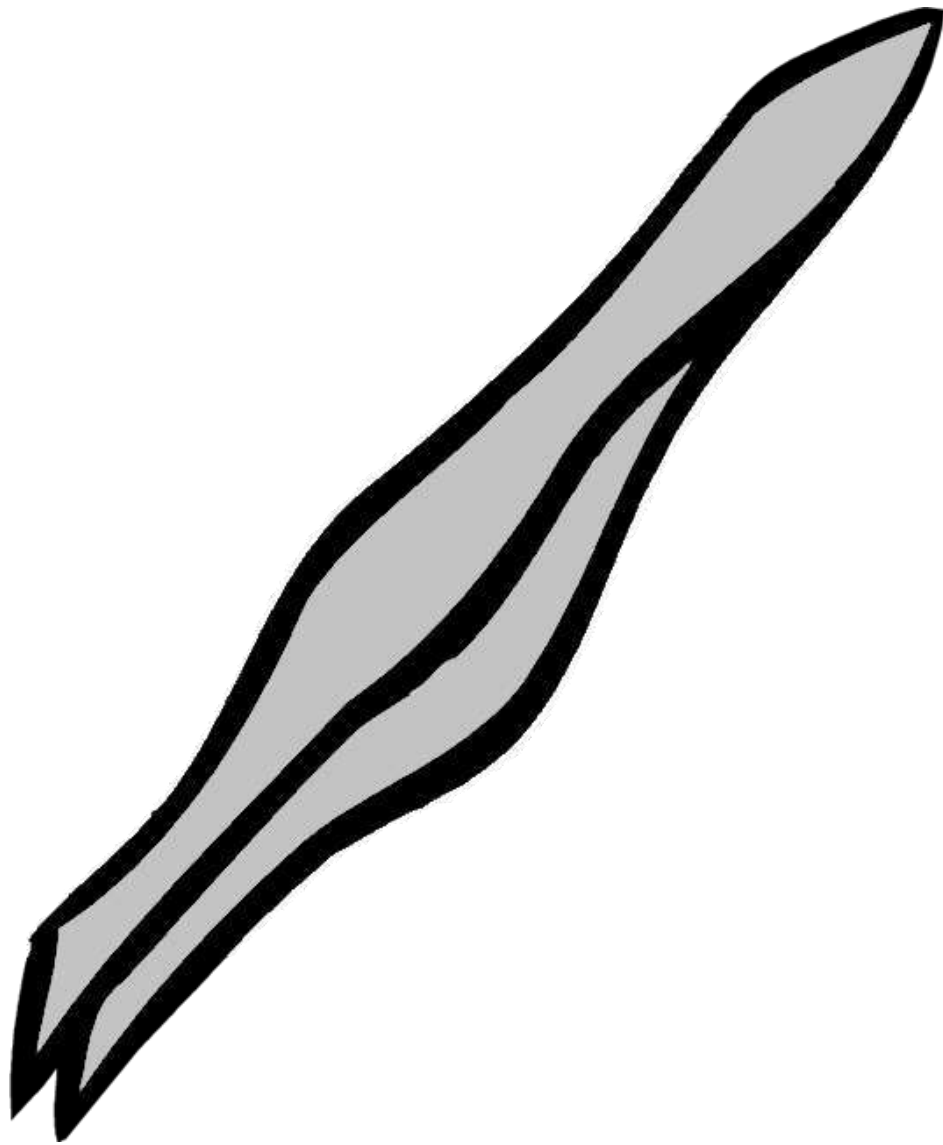

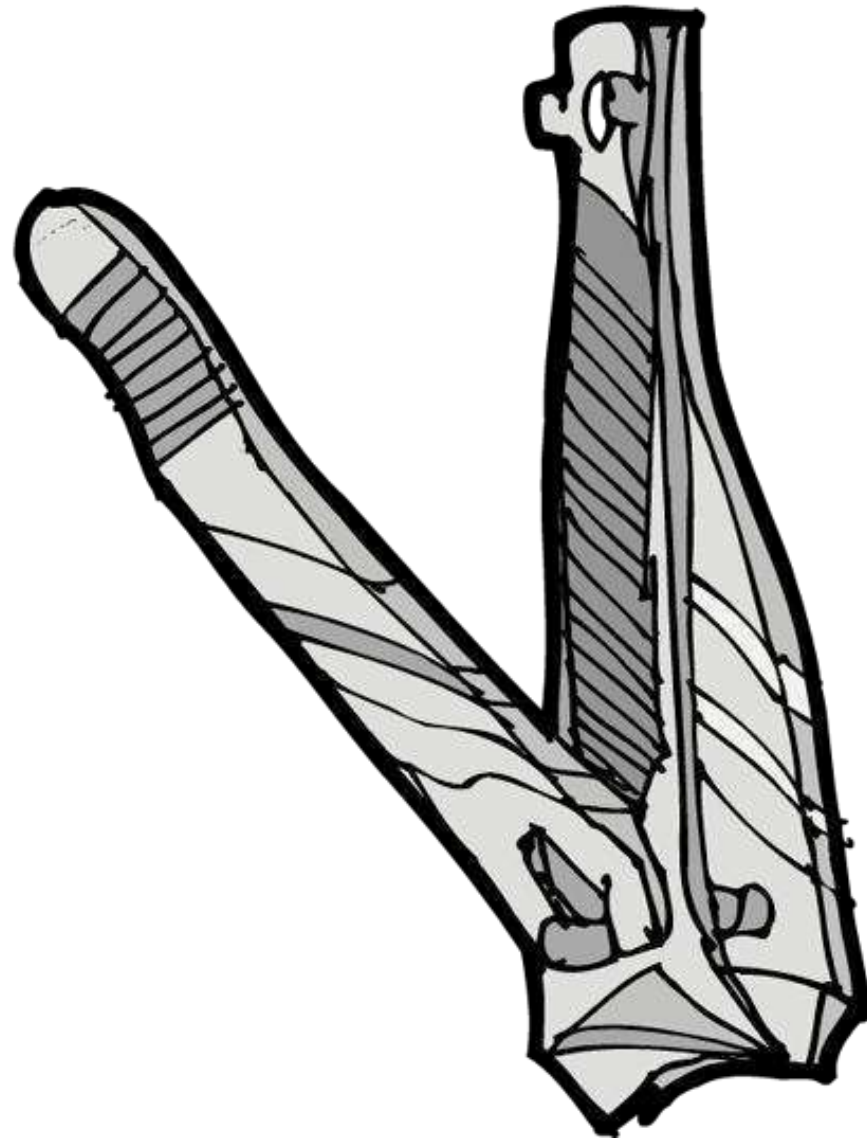

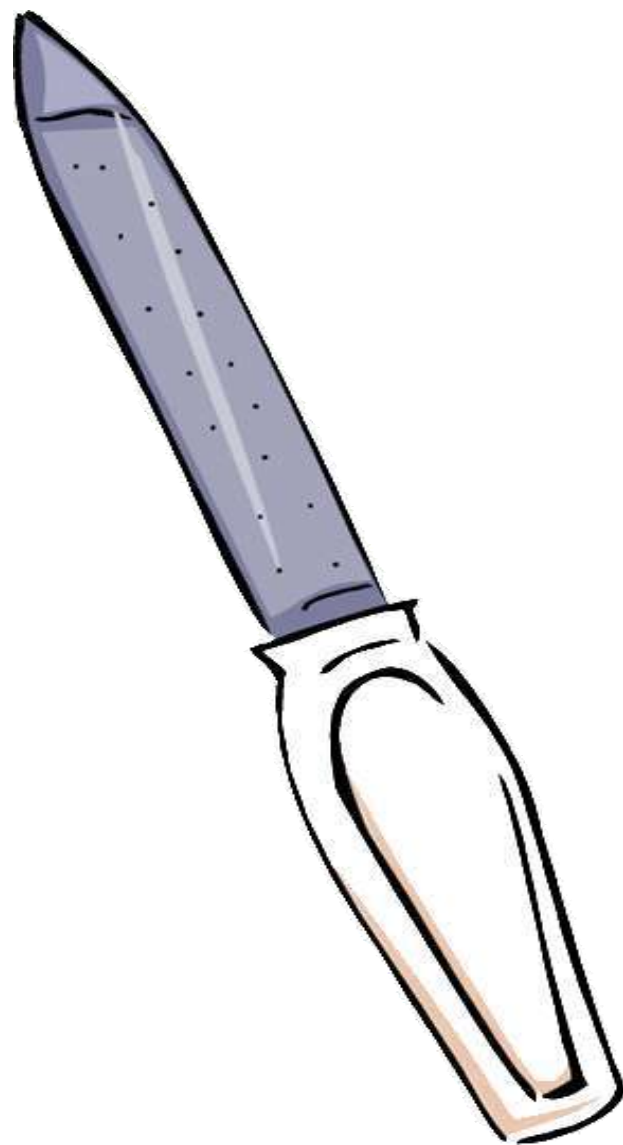

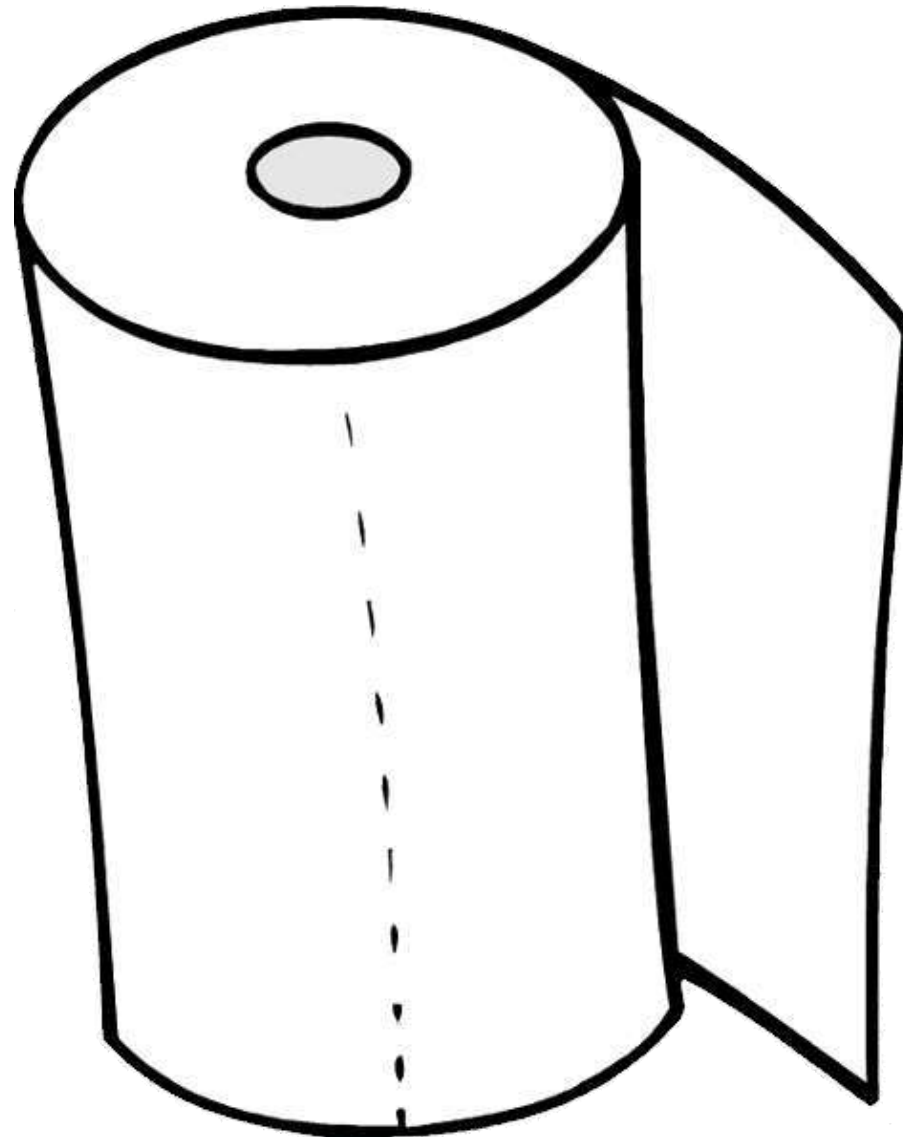

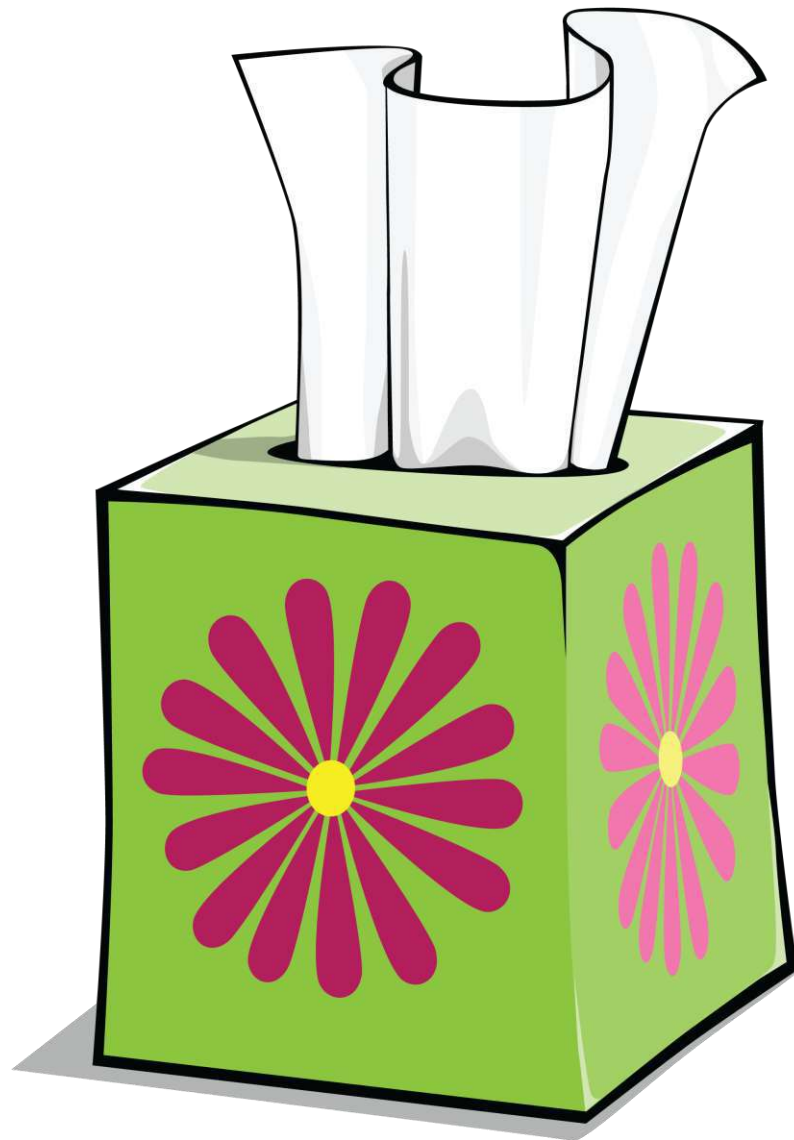

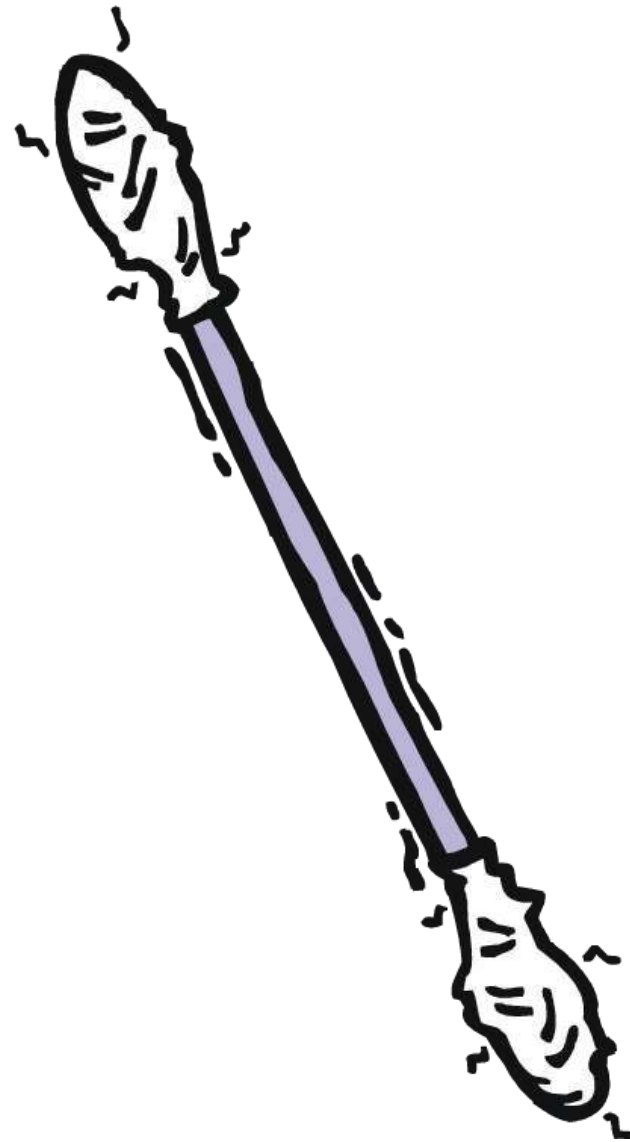

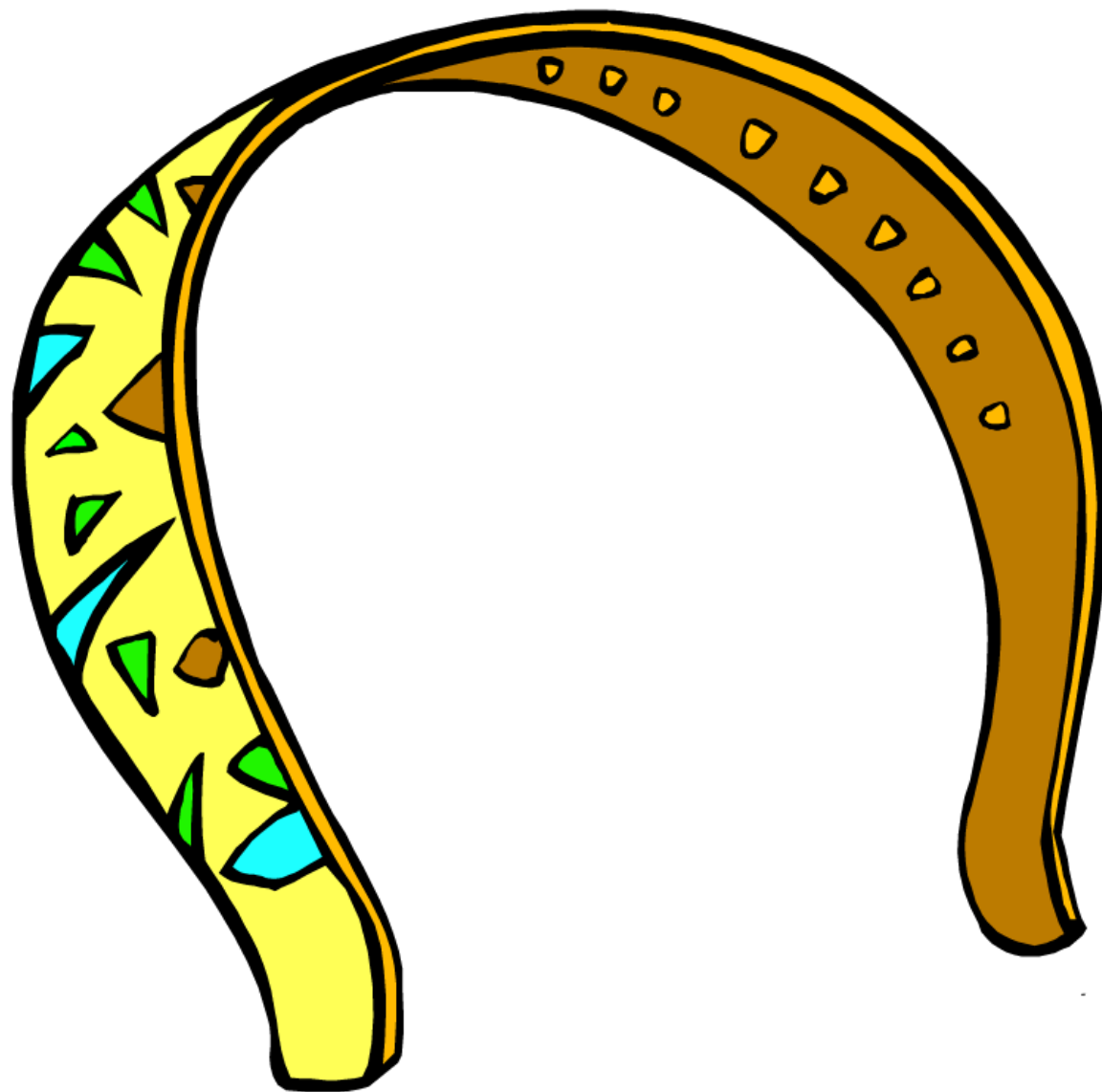

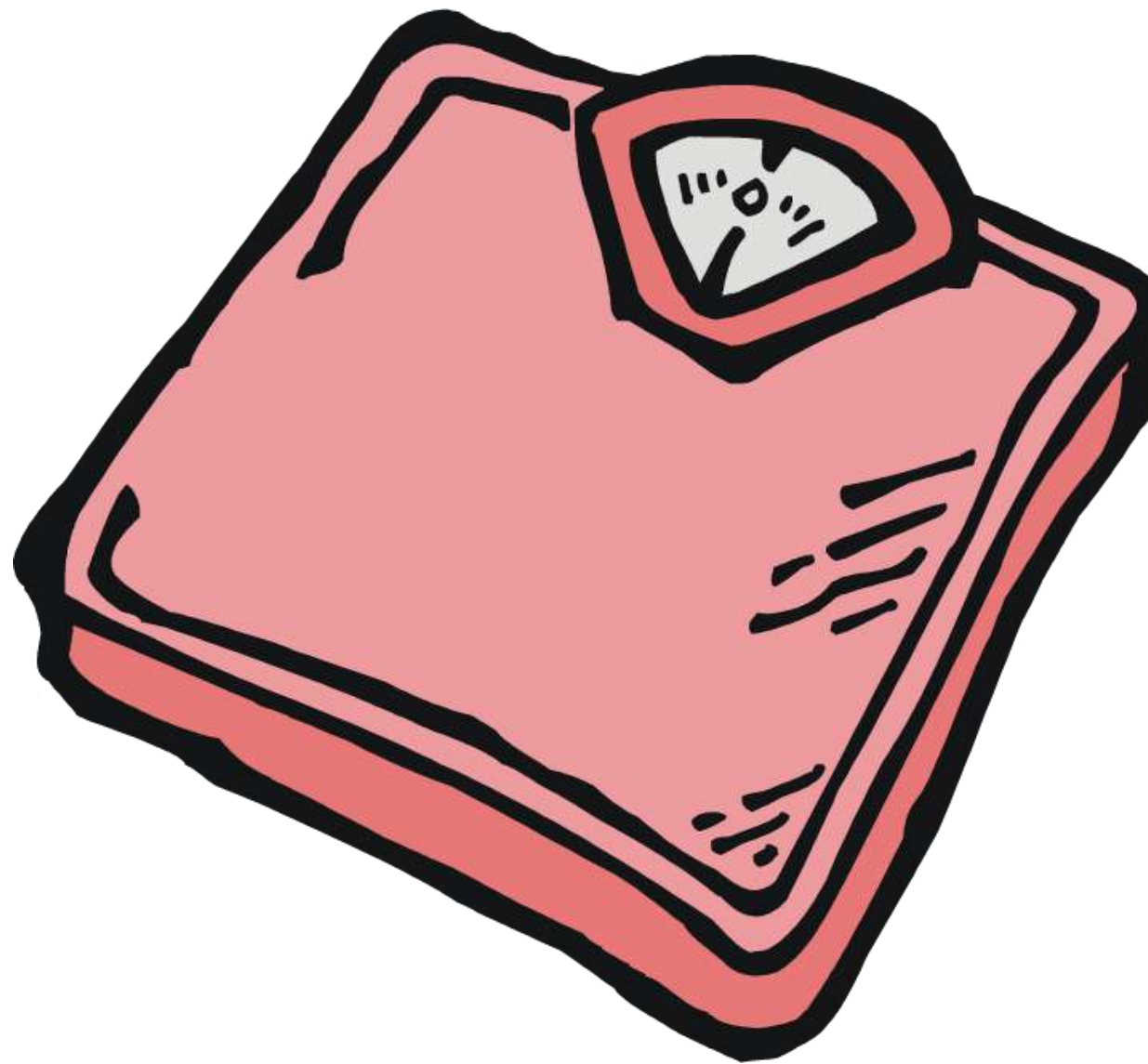

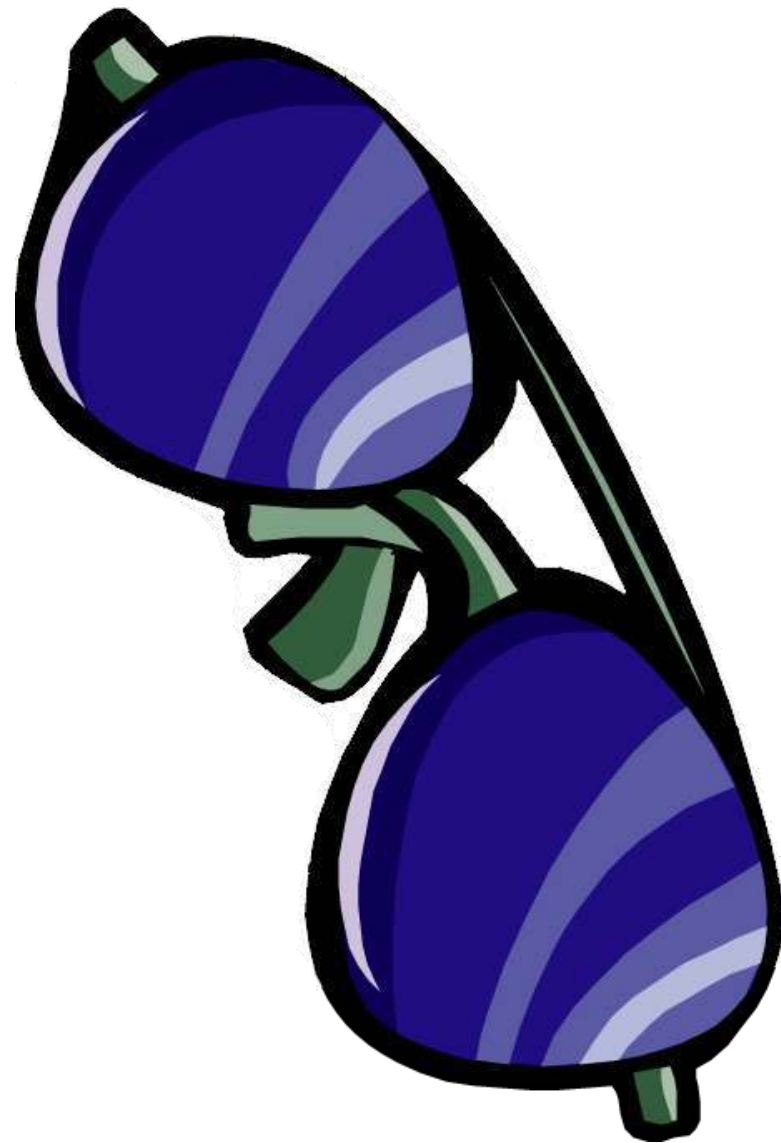

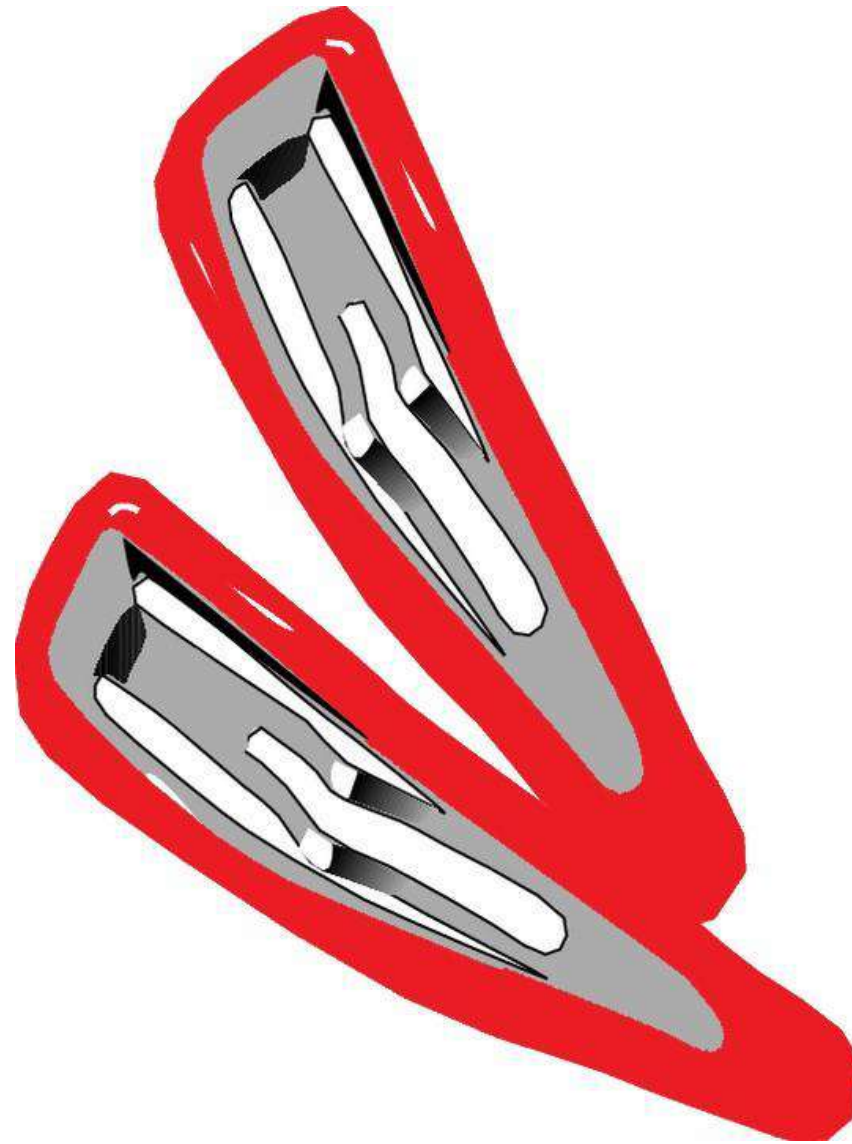

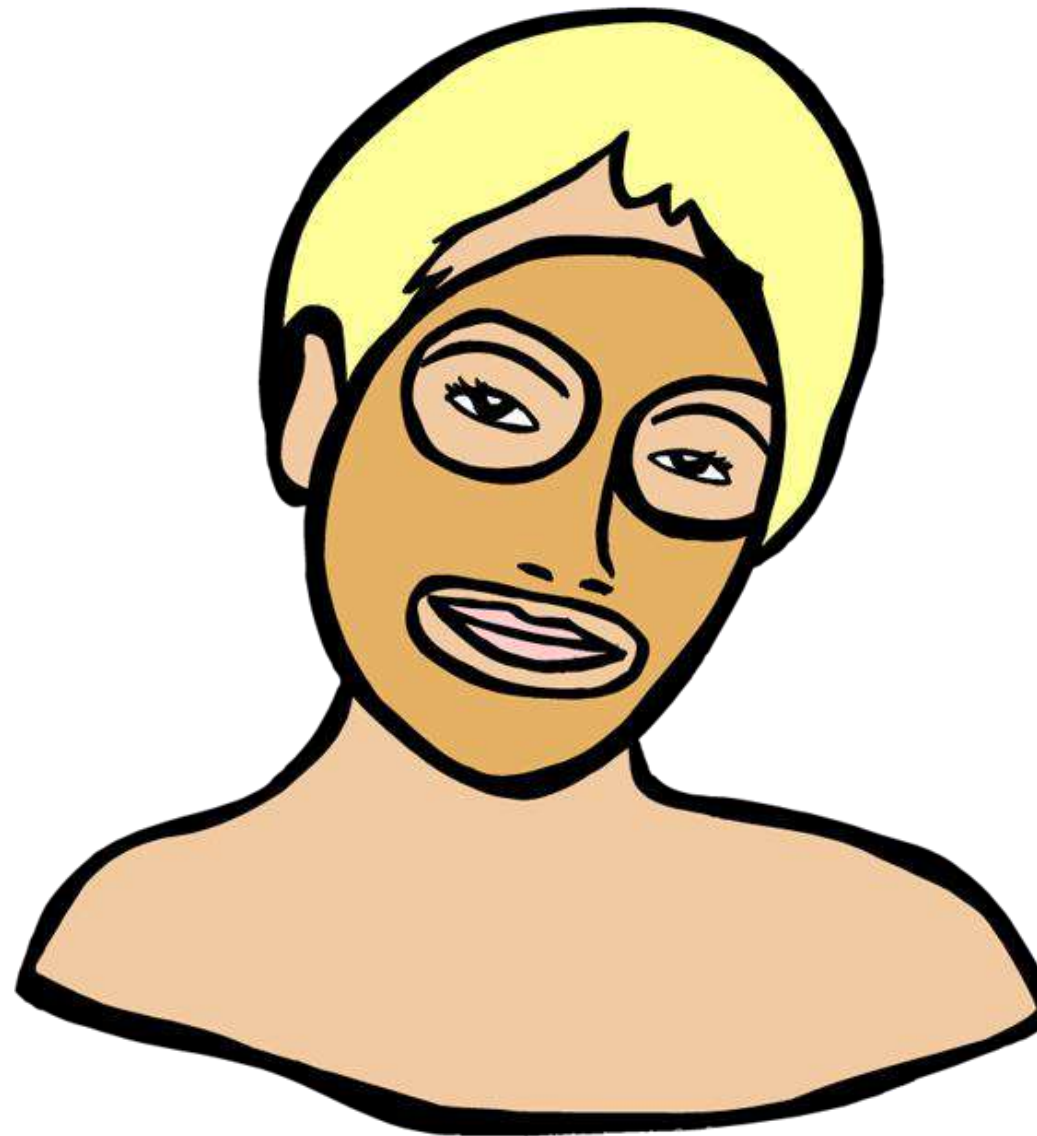



perfume

Copyright © 10/11/2019 englishsheets.com. All rights reserved.



deodorant

Copyright © 10/11/2019 englishsheets.com. All rights reserved.



hand lotion

Copyright © 10/11/2019 englishsheets.com. All rights reserved.



mirror

Copyright © 10/11/2019 englishsheets.com. All rights reserved.



mouthwash

Copyright © 10/11/2019 englishsheets.com. All rights reserved.

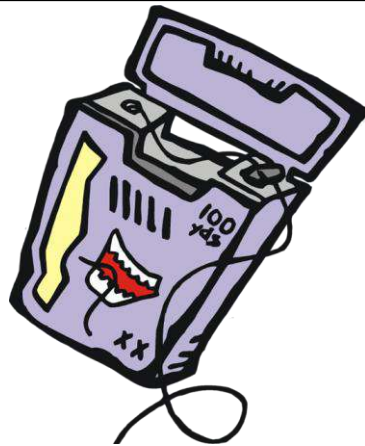

dental floss

Copyright © 10/11/2019 englishsheets.com. All rights reserved.



toothbrush

Copyright © 10/11/2019 englishsheets.com. All rights reserved.



toothpaste

Copyright © 10/11/2019 englishsheets.com. All rights reserved.



lip balm

Copyright © 10/11/2019 englishsheets.com. All rights reserved.

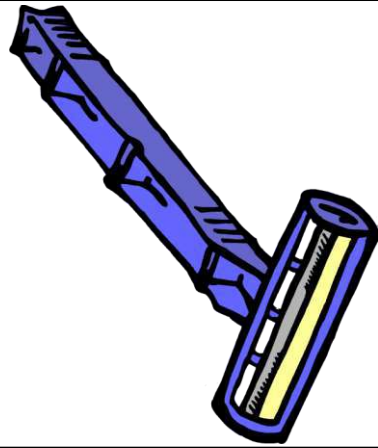

razor

Copyright © 10/11/2019 englishsheets.com. All rights reserved.



shaving foam

Copyright © 10/11/2019 englishsheets.com. All rights reserved.



shampoo

Copyright © 10/11/2019 englishsheets.com. All rights reserved.



shower gel

Copyright © 10/11/2019 englishsheets.com. All rights reserved.

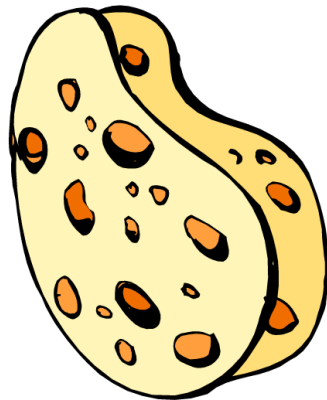

sponge

Copyright © 10/11/2019 englishsheets.com. All rights reserved.



sunscreen

Copyright © 10/11/2019 englishsheets.com. All rights reserved.



hair spray

Copyright © 10/11/2019 englishsheets.com. All rights reserved.



electric razor

Copyright © 10/11/2019 englishsheets.com. All rights reserved.



hair dryer

Copyright © 10/11/2019 englishsheets.com. All rights reserved.

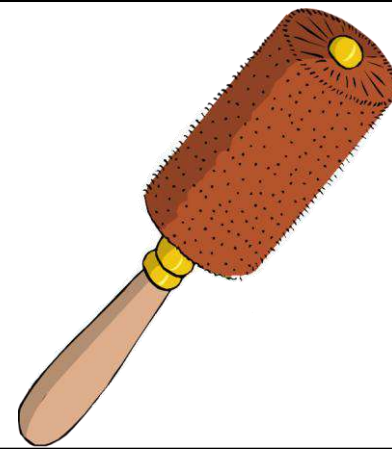

hairbrush

Copyright © 10/11/2019 englishsheets.com. All rights reserved.



scissors

Copyright © 10/11/2019 englishsheets.com. All rights reserved.



comb

Copyright © 10/11/2019 englishsheets.com. All rights reserved.

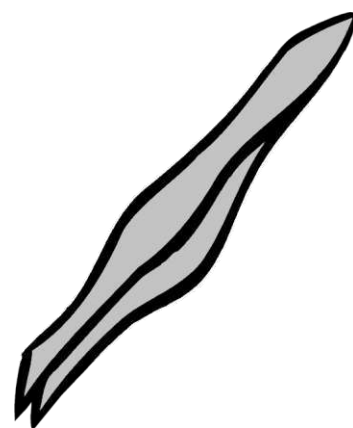

tweezers

Copyright © 10/11/2019 englishsheets.com. All rights reserved.

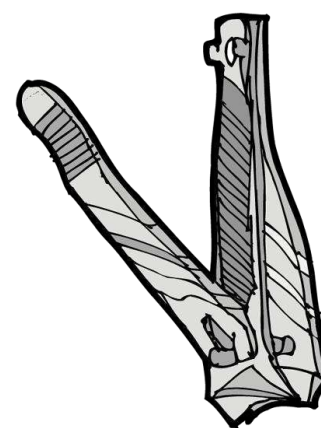

nail clippers

Copyright © 10/11/2019 englishsheets.com. All rights reserved.

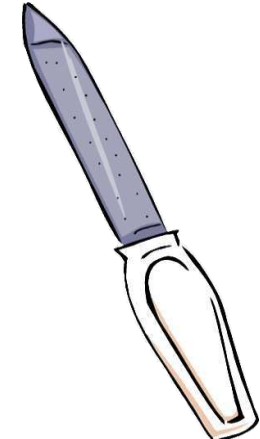

nail file

Copyright © 10/11/2019 englishsheets.com. All rights reserved.

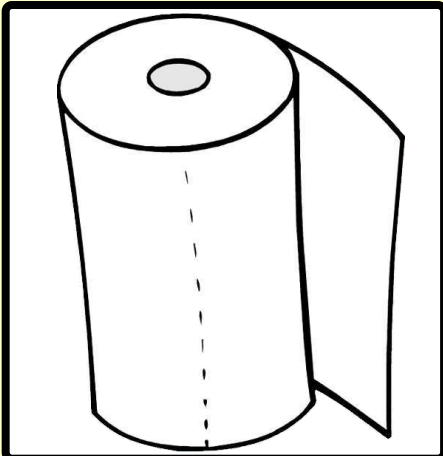

paper towel

Copyright © 10/11/2019 englishsheets.com. All rights reserved.

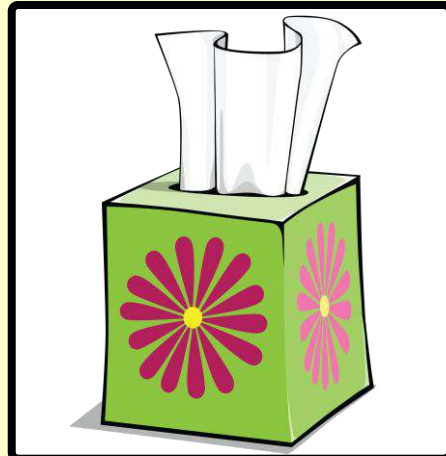

tissues

Copyright © 10/11/2019 englishsheets.com. All rights reserved.

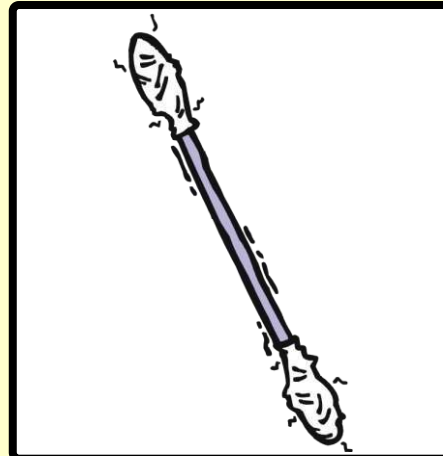

cotton bud

Copyright © 10/11/2019 englishsheets.com. All rights reserved.

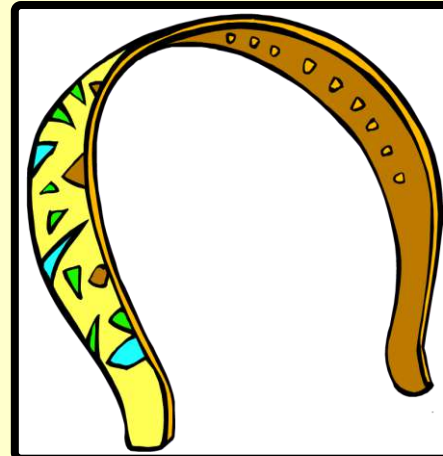

hairband

Copyright © 10/11/2019 englishsheets.com. All rights reserved.

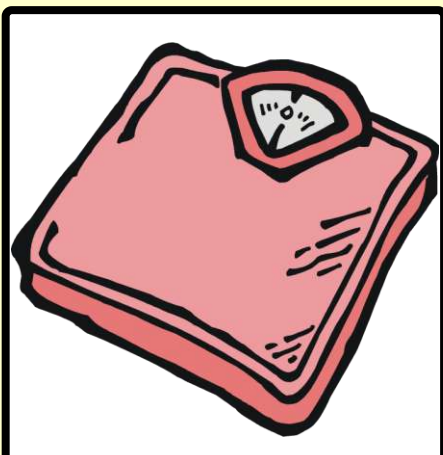

scales

Copyright © 10/11/2019 englishsheets.com. All rights reserved.

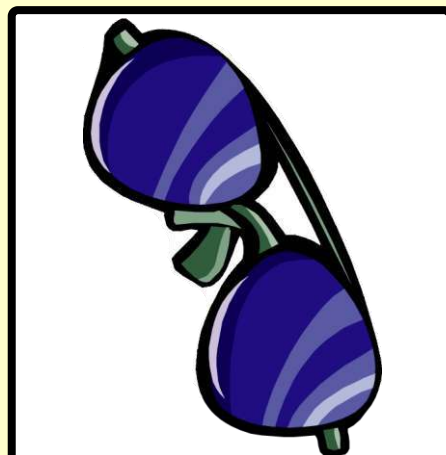

sunglasses

Copyright © 10/11/2019 englishsheets.com. All rights reserved.

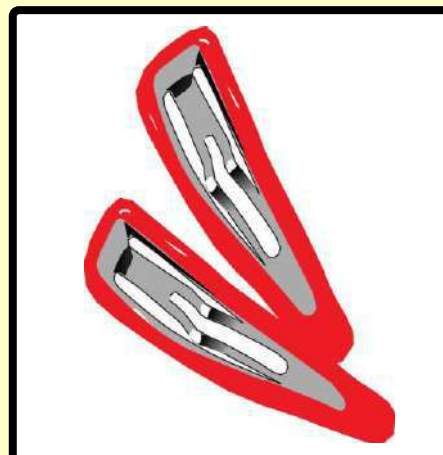

hair clips

Copyright © 10/11/2019 englishsheets.com. All rights reserved.

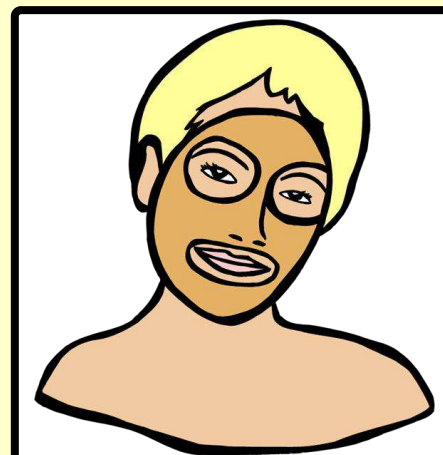

facial mask

Copyright © 10/11/2019 englishsheets.com. All rights reserved.

PERSONAL CARE PRODUCTS FIDGET SPINNER GAME



- Cut a small arrow from paper or craft foam and stick it onto the fidget spinner as your pointer.
- Place the fidget spinner in the middle of the vocabulary circle.
- Spin it and say the word quickly!

PERSONAL CARE PRODUCTS FIDGET SPINNER GAME



- Cut a small arrow from paper or craft foam and stick it onto the fidget spinner as your pointer.
- Place the fidget spinner in the middle of the vocabulary circle.
- Spin it and say the word quickly!

PERSONAL CARE PRODUCTS FIDGET SPINNER GAME



- Cut a small arrow from paper or craft foam and stick it onto the fidget spinner as your pointer.
- Place the fidget spinner in the middle of the vocabulary circle.
- Spin it and say the word quickly!

PERSONAL CARE PRODUCTS FIDGET SPINNER GAME



- Cut a small arrow from paper or craft foam and stick it onto the fidget spinner as your pointer.
- Place the fidget spinner in the middle of the vocabulary circle.
- Spin it and say the word quickly!



perfume

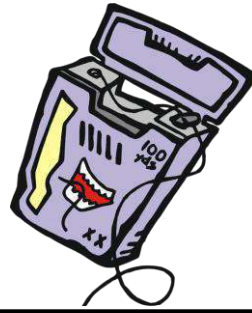

deodorant



hand lotion



mirror

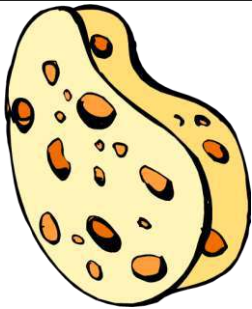

mouthwash



dental floss



toothbrush



toothpaste



lip balm



razor



shaving foam

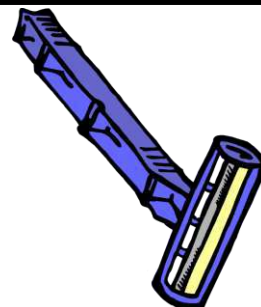

shampoo



shower gel



sponge



sunscreen

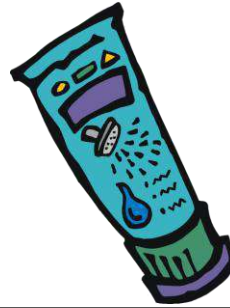

hair spray

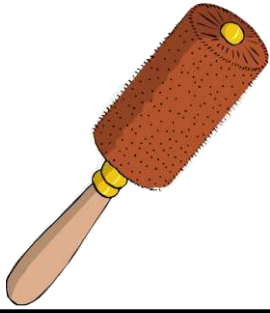

electric razor

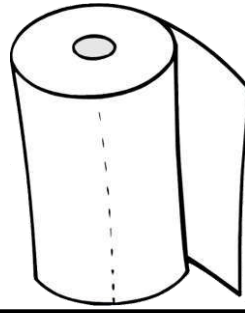

hair dryer

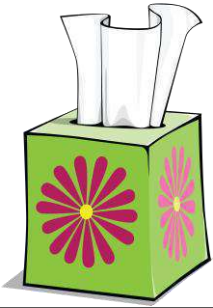

hairbrush

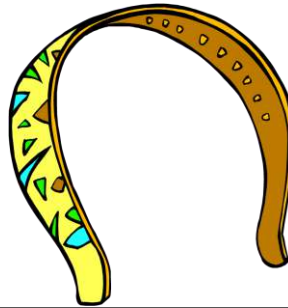

scissors



comb



tweezers



nail clippers

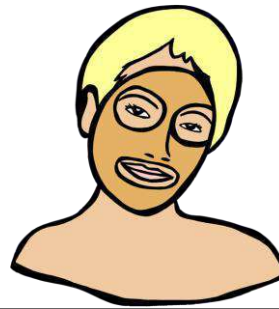

nail file

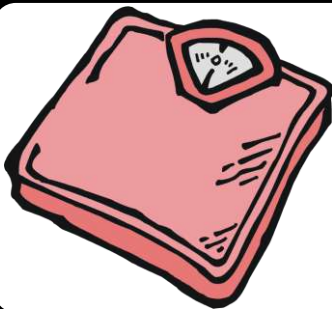

paper towel



tissues



cotton bud

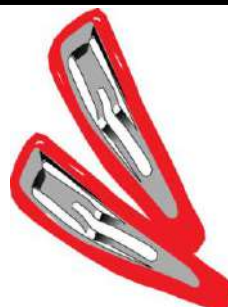

hairband

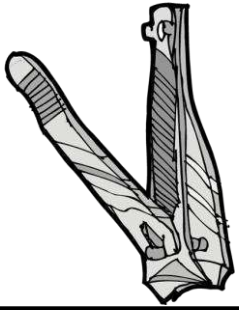

scales

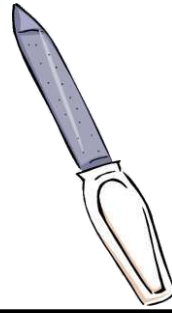

sunglasses



hair clips

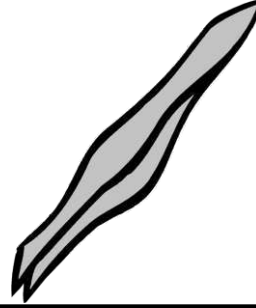

facial mask

PETS PICTURE DICTIONARY



dog



cat

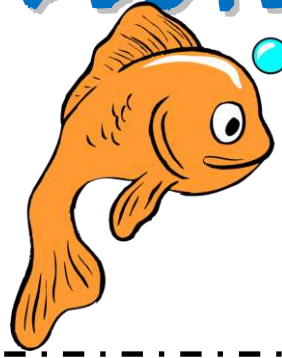

fish



mouse



canary



hamster

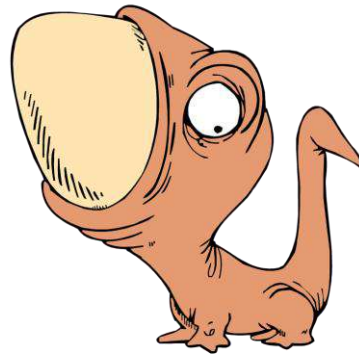

lizard



chameleon

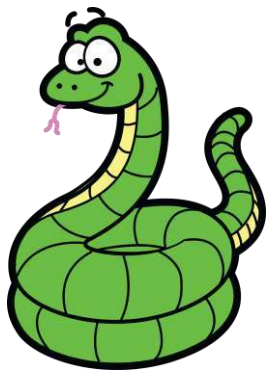

snake



parrot

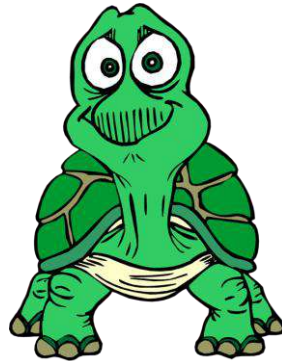

turtle

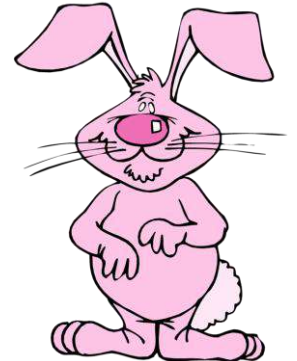

rabbit

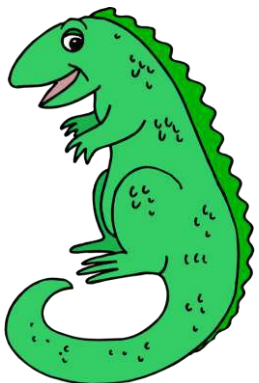

iguana

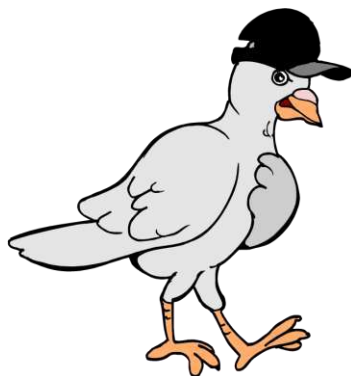

pigeon



duck

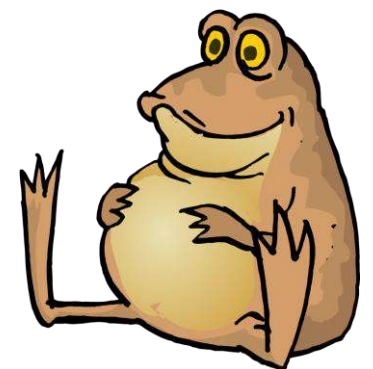

frog

PETS PICTURE DICTIONARY



dog



cat

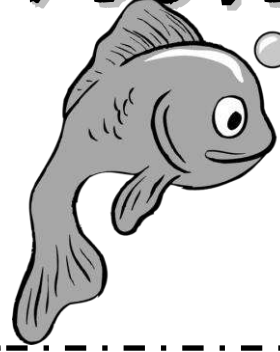

fish



mouse



canary



hamster

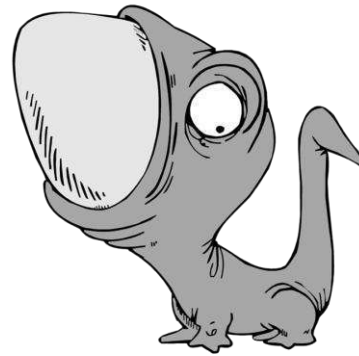

lizard

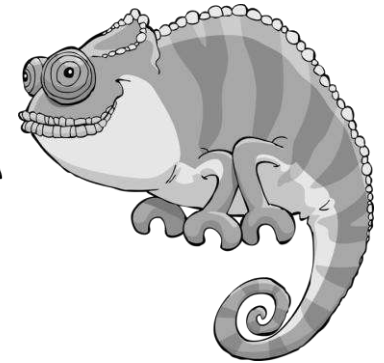

chameleon

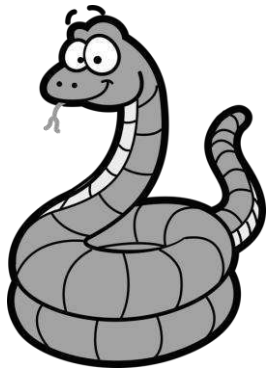

snake



parrot

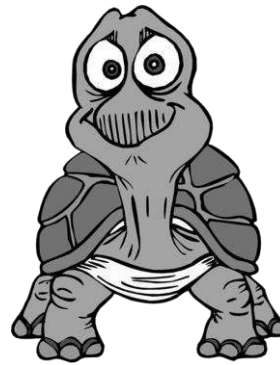

turtle

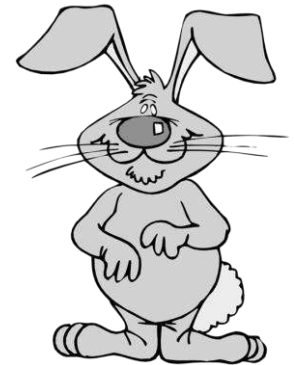

rabbit



iguana

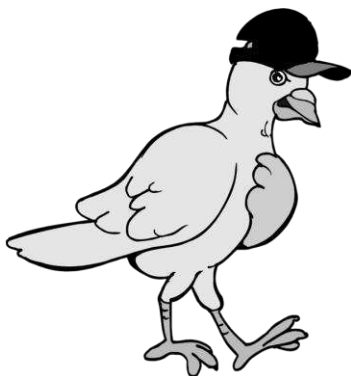

pigeon



duck



frog

PETS ESL VOCABULARY MATCHING WORKSHEET

Choose the correct words from the list below and write them under the correct pictures

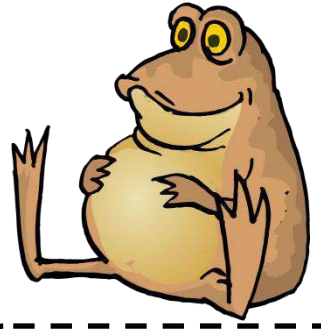
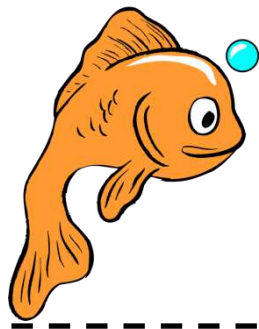

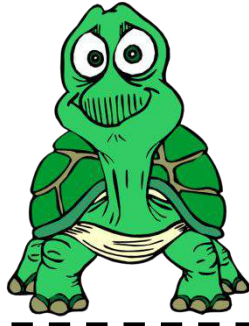

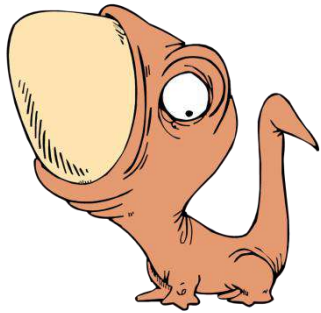

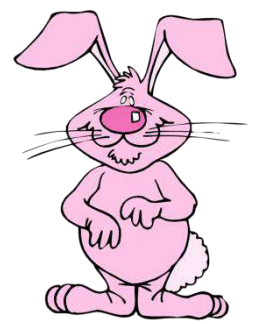
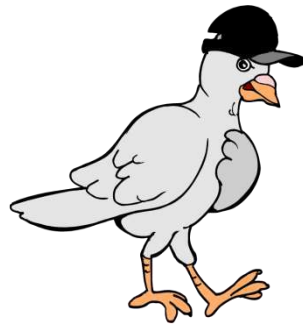
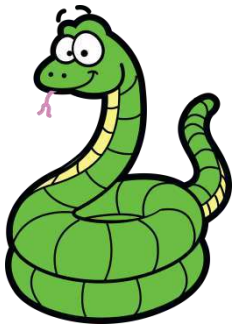

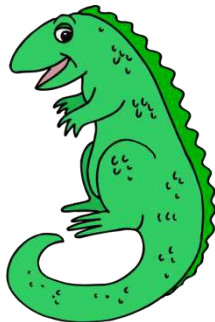

WORD LIST

- dog
- cat
- fish
- mouse
- canary
- hamster
- lizard
- chameleon
- snake
- parrot
- turtle
- rabbit
- iguana
- pigeon
- duck
- frog

PETS ESL VOCABULARY MATCHING WORKSHEET ANSWER KEY

Choose the correct words from the list below and write them under the correct pictures



parrot

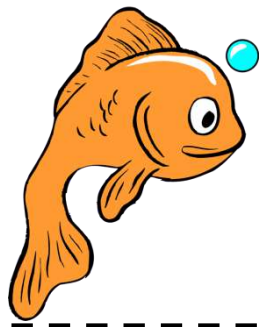

fish

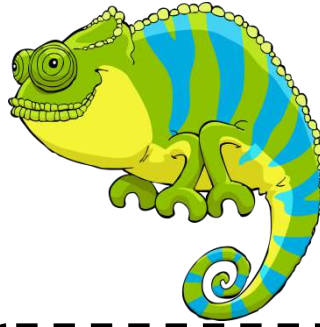

chameleon

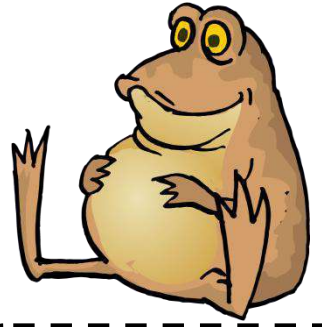

frog



mouse

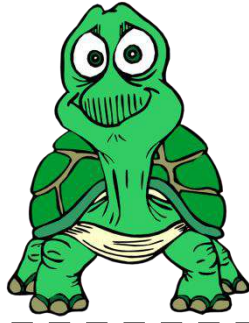

turtle

WORD LIST

- dog
- cat
- fish
- mouse
- canary
- hamster
- lizard
- chameleon
- snake
- parrot
- turtle
- rabbit
- iguana
- pigeon
- duck
- frog

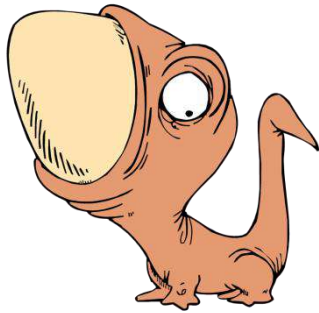

lizard



duck

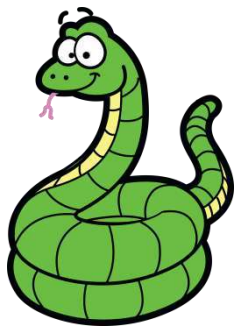

snake

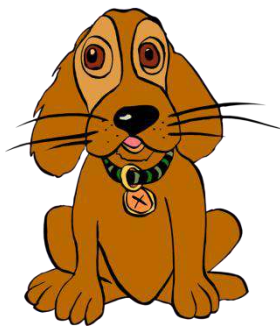

dog

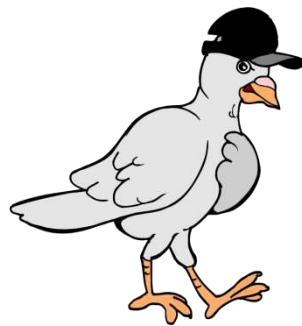

pigeon

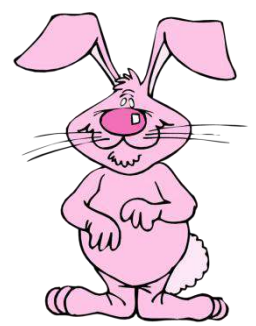

rabbit



canary

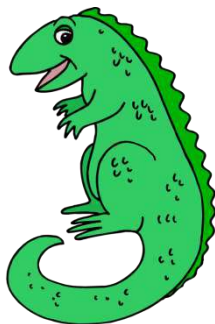

iguana



cat



hamster

PETS VOCABULARY WORD SEARCH PUZZLE

Find and circle the words in the word search puzzle and number the pictures

r	a	b	b	i	t	d	u	c	k	k	z	x	b	t
h	s	z	i	g	u	a	n	a	g	g	v	v	i	j
c	h	a	m	e	l	e	o	n	k	z	t	j	x	m
f	s	c	h	e	i	u	e	a	f	i	s	h	p	v
g	q	c	a	t	z	p	a	r	r	o	t	f	u	l
q	i	s	m	z	a	l	v	y	p	z	a	w	o	g
s	r	h	s	y	r	d	o	g	v	g	s	c	x	u
r	t	t	t	y	d	n	i	f	u	f	r	o	g	e
m	f	c	e	p	i	g	e	o	n	i	x	l	s	g
o	t	u	r	t	l	e	b	q	m	n	l	m	s	n
u	o	k	u	g	d	m	n	n	b	e	q	q	n	m
s	h	q	u	i	p	f	x	o	o	f	l	f	a	r
e	q	b	n	i	t	w	f	a	p	o	c	s	k	e
o	x	c	x	s	c	w	a	v	i	e	l	l	e	n
u	s	i	k	y	g	r	i	t	o	a	c	u	t	g

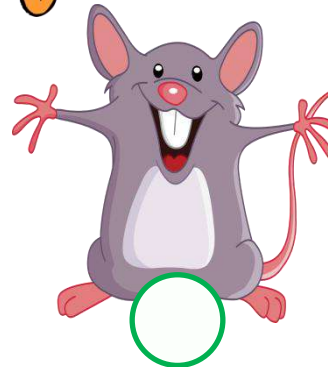
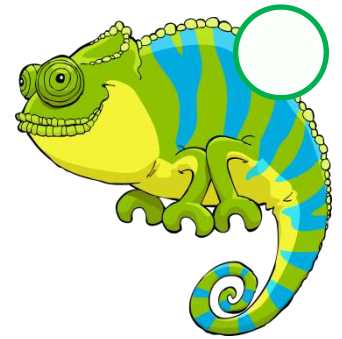
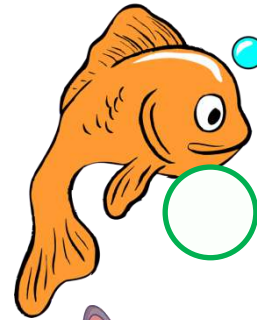
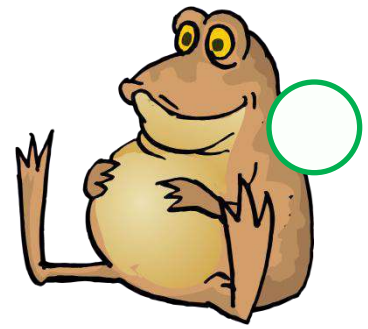
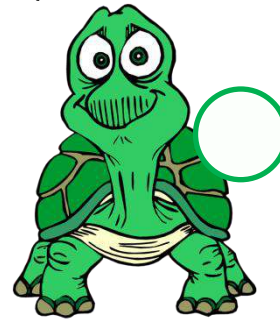

1. dog
2. cat
3. fish
4. mouse
5. canary
6. hamster
7. lizard
8. chameleon
9. snake
10. parrot
11. turtle
12. rabbit
13. iguana
14. pigeon
15. duck
16. frog

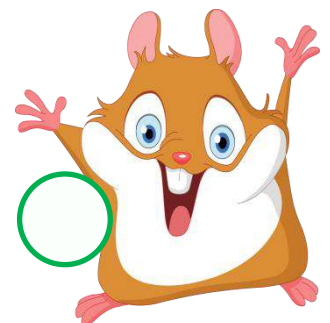
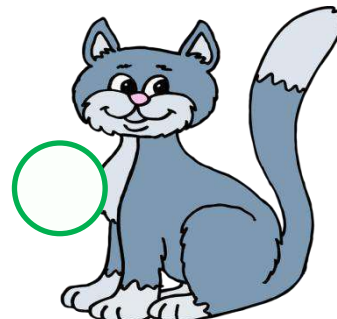
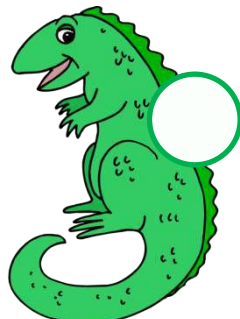
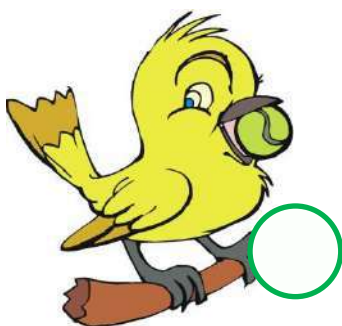
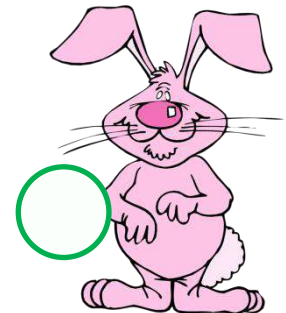
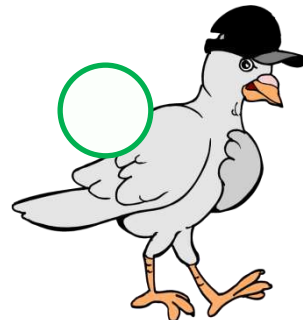
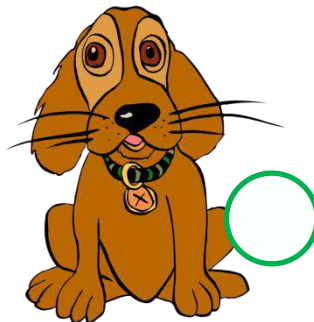
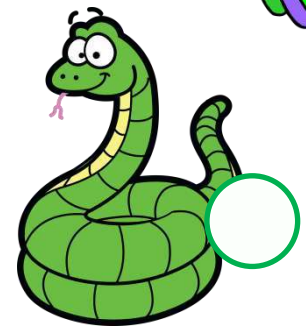
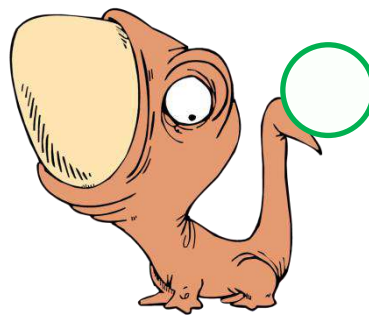
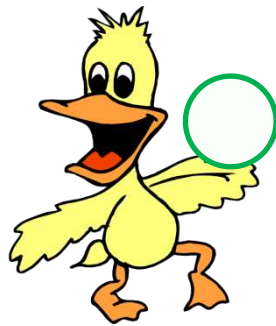

PETS VOCABULARY WORD SEARCH PUZZLE ANSWER KEY

Find and circle the words in the word search puzzle and number the pictures

r	a	b	b	i	t	d	u	c	k	k	z	x	b	t
h	s	z	i	g	u	a	n	a	g	g	v	v	i	j
c	h	a	m	e	l	e	o	n	k	z	t	j	x	m
f	s	c	h	e	i	u	e	a	f	i	s	h	p	v
g	q	c	a	t	z	p	a	r	r	o	t	f	u	l
q	i	s	m	z	a	l	v	y	p	z	a	w	o	g
s	r	h	s	y	r	d	o	g	v	g	s	c	x	u
r	t	t	t	y	d	n	i	f	u	f	r	o	g	e
m	f	c	e	p	i	g	e	o	n	i	x	l	s	g
o	t	u	r	t	l	e	b	q	m	n	l	m	s	n
u	o	k	u	g	d	m	n	n	b	e	q	q	n	m
s	h	q	u	i	p	f	x	o	o	f	l	f	a	r
e	q	b	n	i	t	w	f	a	p	o	c	s	k	e
o	x	c	x	s	c	w	a	v	i	e	l	l	e	n
u	s	i	k	y	g	r	i	t	o	a	c	u	t	g

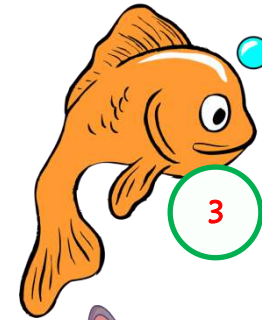
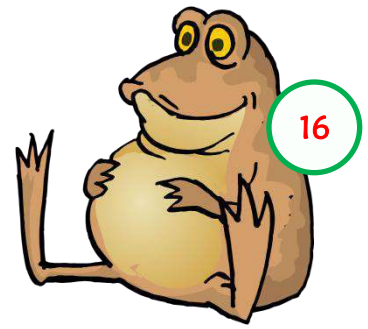
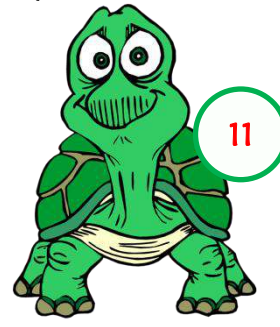

1. dog
2. cat
3. fish
4. mouse
5. canary
6. hamster
7. lizard
8. chameleon
9. snake
10. parrot
11. turtle
12. rabbit
13. iguana
14. pigeon
15. duck
16. frog

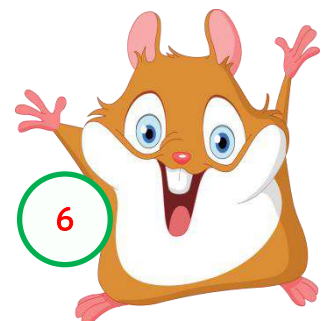
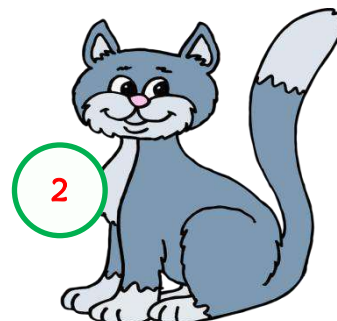
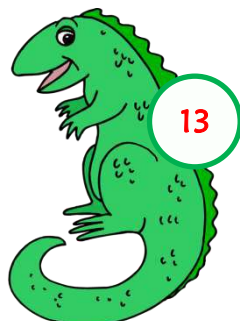
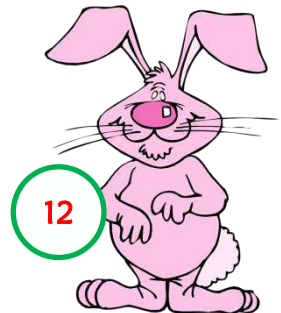
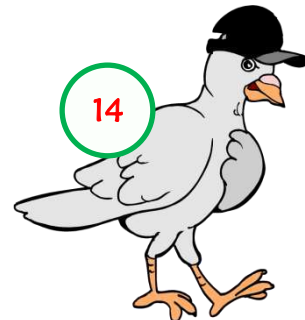
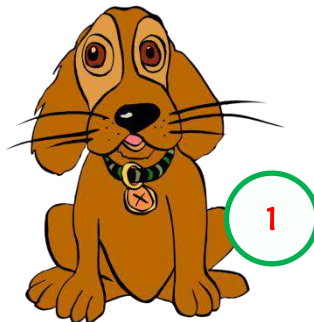
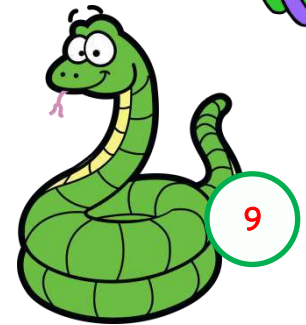
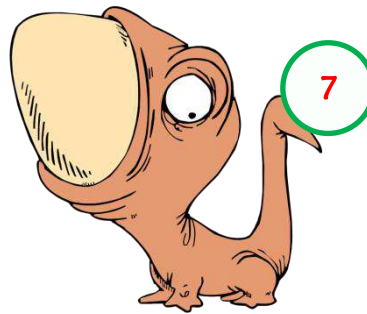
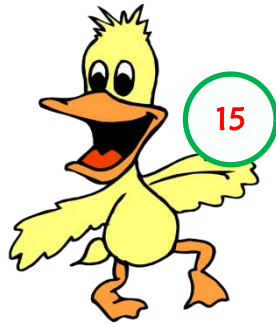

PETS ESL CROSSWORD PUZZLE

Look at the numbers on the pictures and write the pets vocabulary in the crossword puzzle

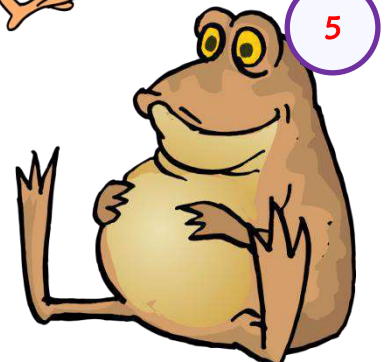
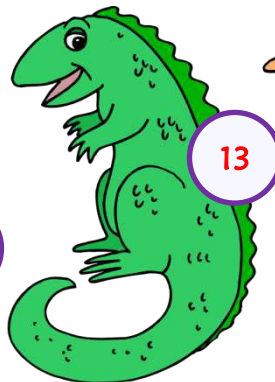
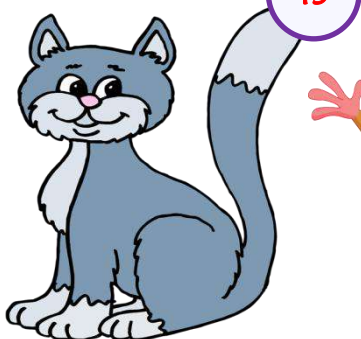
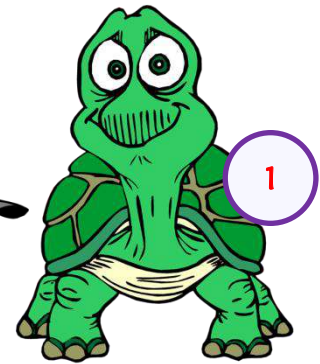
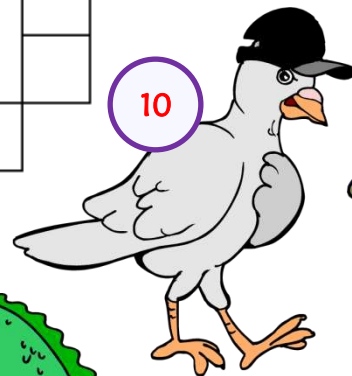
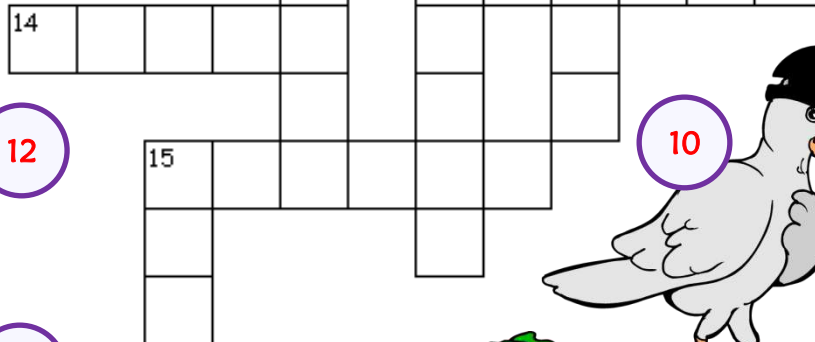
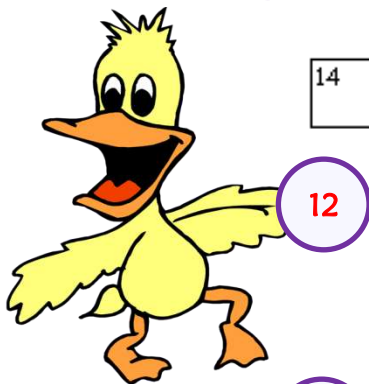
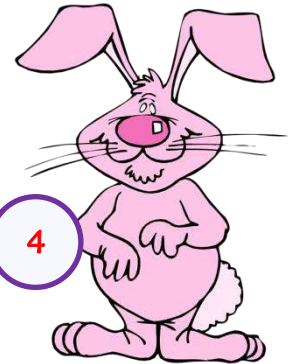
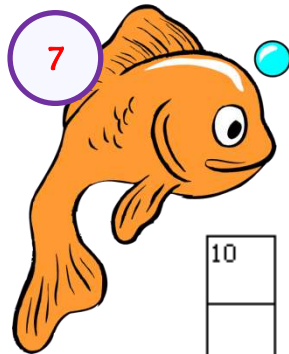
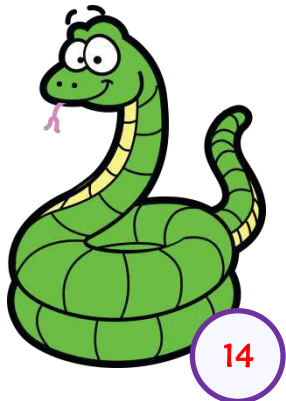
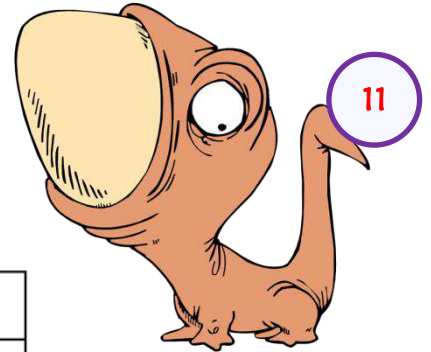
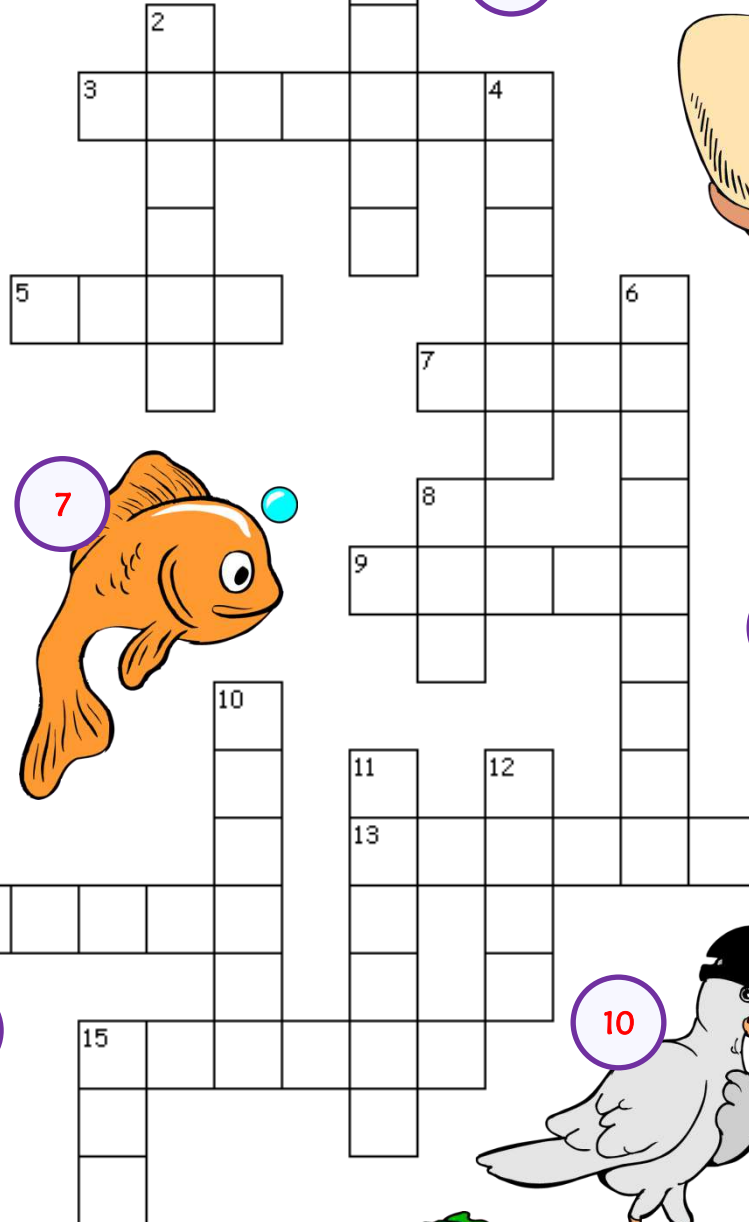
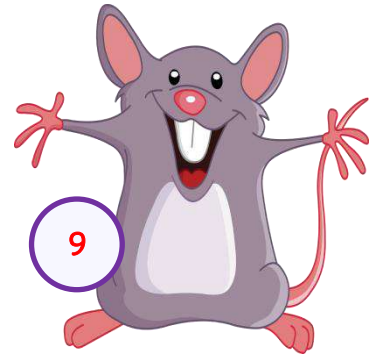
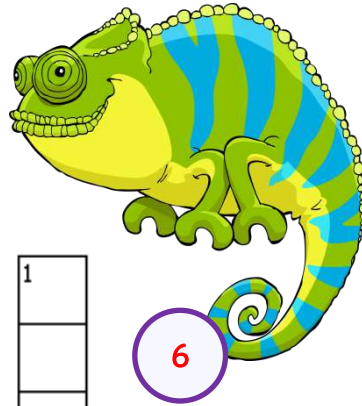
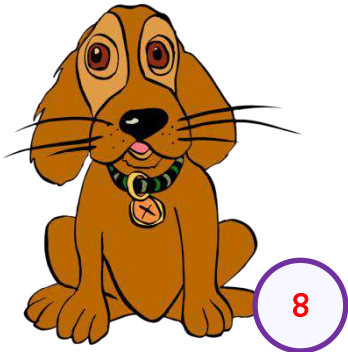

ANSWER KEY

Across

3. hamster

5. frog

7. fish

9. mouse

13. iguana

14. snake

15. canary

Down

1. turtle

2. parrot

4. rabbit

6. chameleon

8. dog

10. pigeon

11. lizard

12. duck

15. cat

PETS MISSING LETTERS IN WORDS

Write the missing letters in the boxes to complete the pets vocabulary



ch _ m _ l _ _ n

c _ t

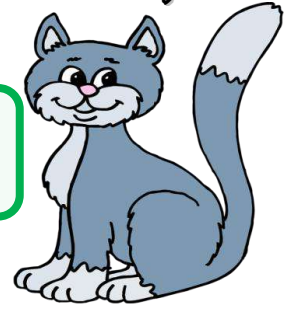

m _ _ s _

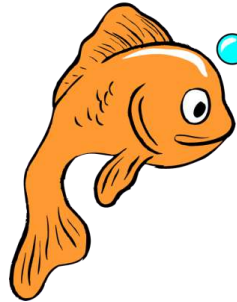

f _ s h



c _ n _ r y

h _ m s t _ r



l _ z _ r d

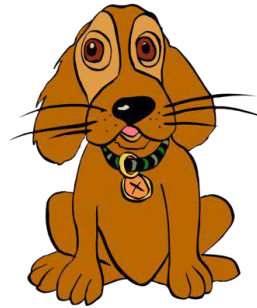
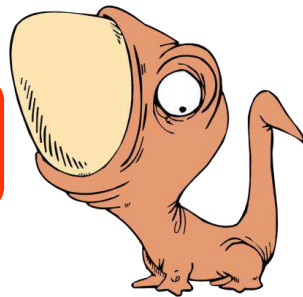

d _ g

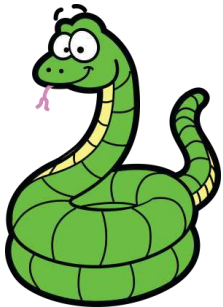

s n _ k _

p _ r r _ t



t _ r t l _

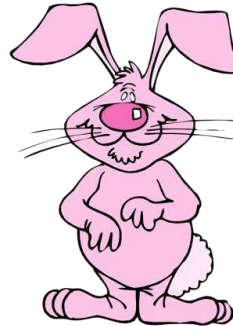
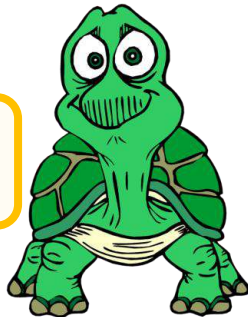

r _ b b _ t

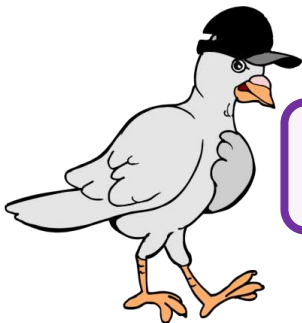

p _ g _ _ n

_ g _ _ n _

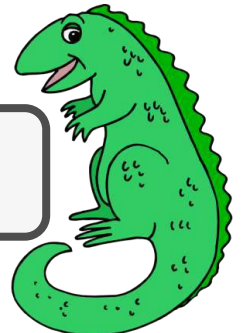

d _ c k



f r _ g

PETS MISSING LETTERS IN WORDS ANSWER KEY

Write the missing letters in the boxes to complete the pets vocabulary



chameeleon

cat

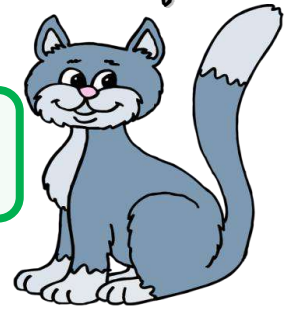

mouse

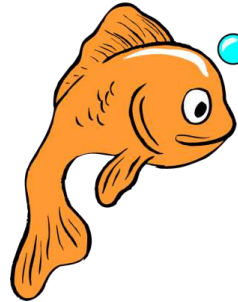

fish



canary

hamster



lizard

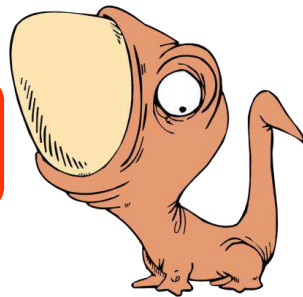

dog

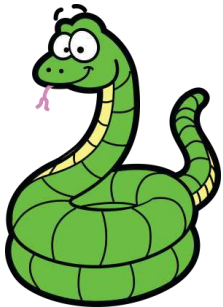

snake

parrot



turtle

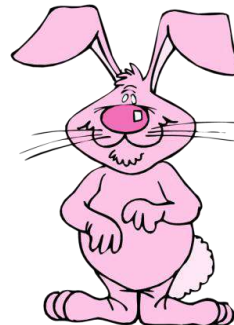
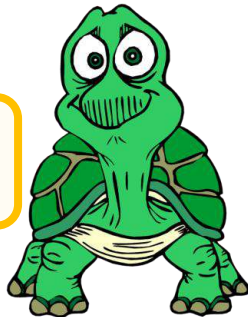

rabbit

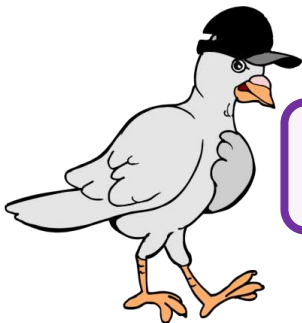

pigeon

iguana

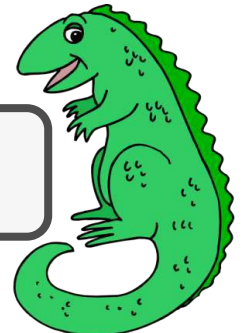

duck



frog

PETS UNSCRAMBLE THE WORDS

Unscramble the pets vocabulary and number the pictures

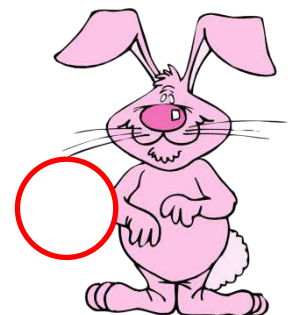
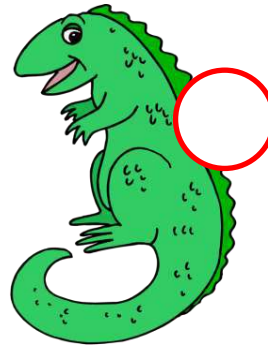
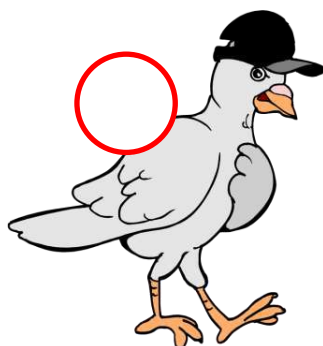
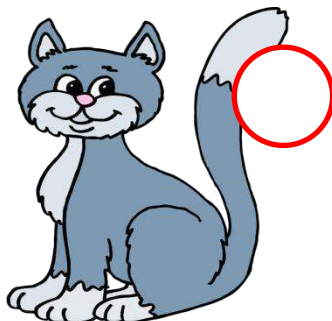
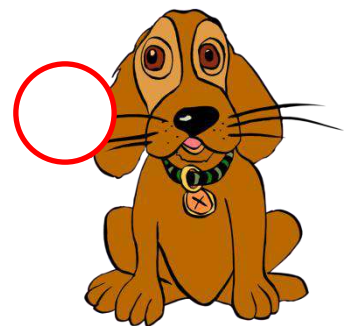
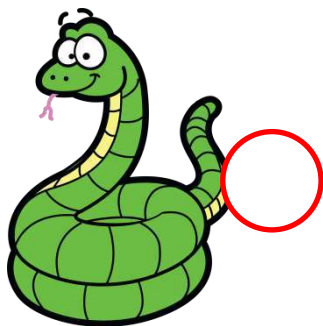
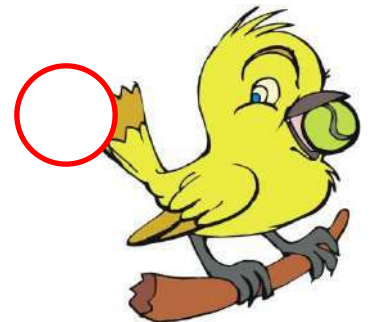
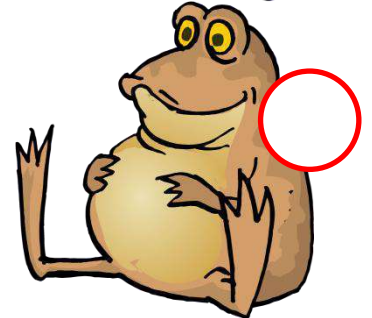
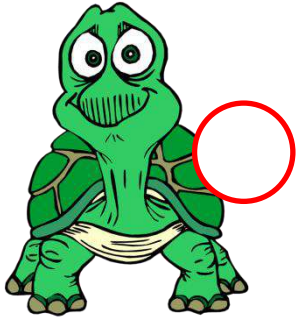
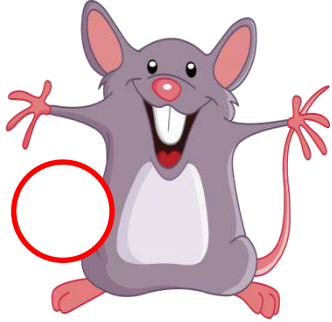
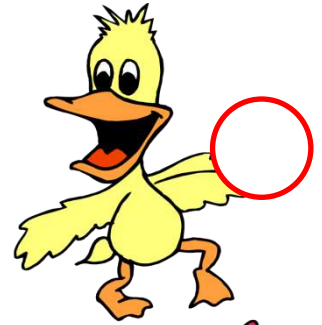
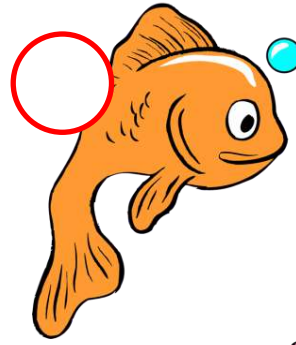
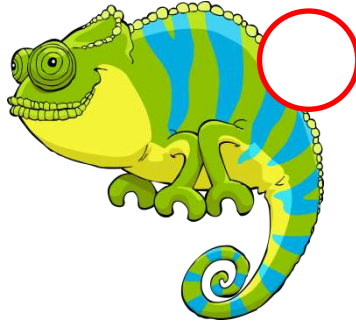
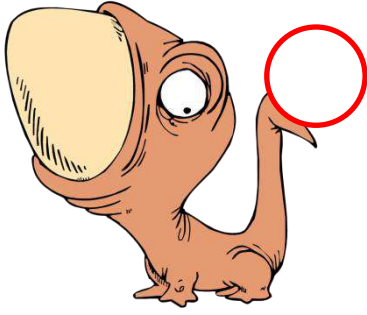

1. dgo

2. tca

3. ihfs

4. mueso

5. yracna

6. hrmetsa

7. drazil

8. cnmohalee

9. ankse

10. ptaorr

11. ulrtte

12. btbiar

13. uaiang

14. oignpe

15. cukd

16. rfog

PETS UNSCRAMBLE THE WORDS ANSWER KEY

Unscramble the pets vocabulary and number the pictures

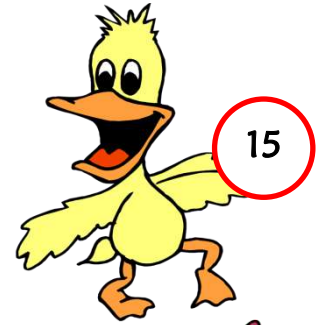
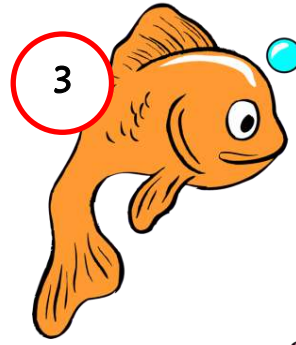
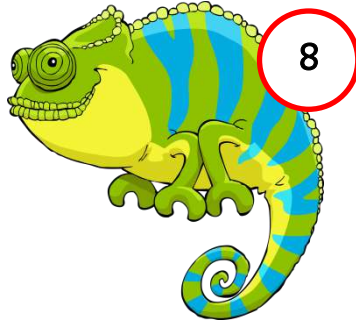
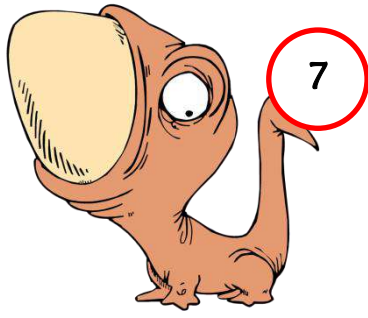

- | | |
|--------------|-----------|
| 1. dgo | dog |
| 2. tca | cat |
| 3. ihfs | fish |
| 4. mueso | mouse |
| 5. yracna | canary |
| 6. hrmetsa | hamster |
| 7. drazil | lizard |
| 8. cnmohalee | chameleon |
| 9. ankse | snake |
| 10. ptaorr | parrot |
| 11. ulrtte | turtle |
| 12. btbiar | rabbit |
| 13. uaiang | iguana |
| 14. oignpe | pigeon |
| 15. cukd | duck |
| 16. rfog | frog |

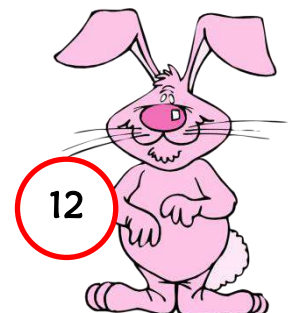
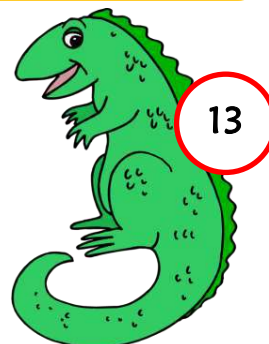
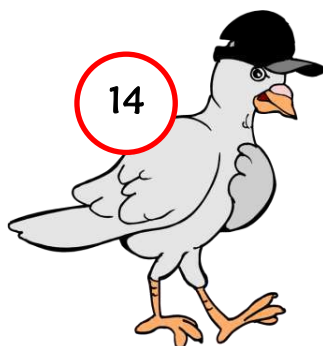
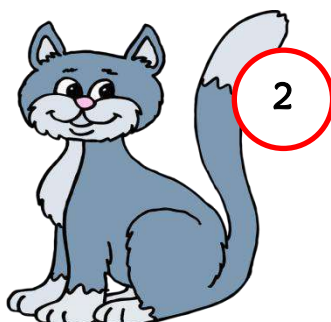
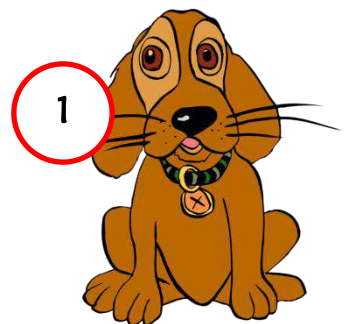
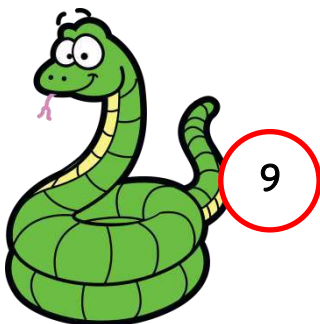
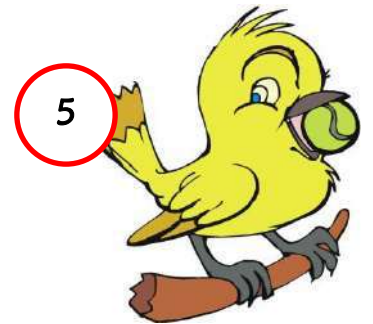
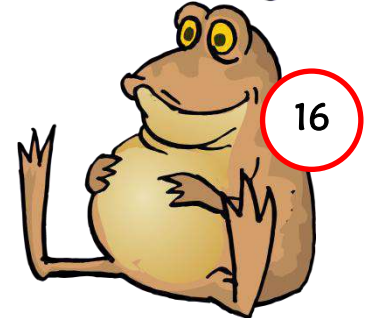
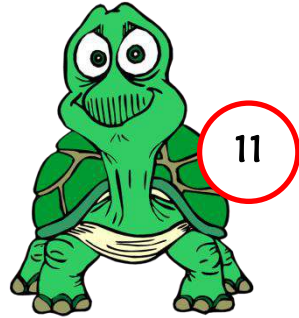
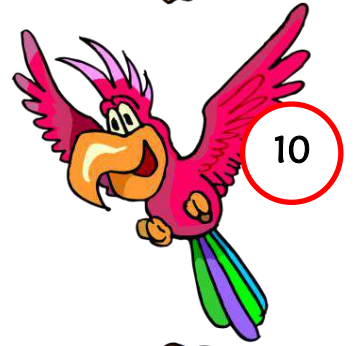

PETS VOCABULARY MULTIPLE CHOICE TEST

Look at the pictures, choose and circle the correct option.

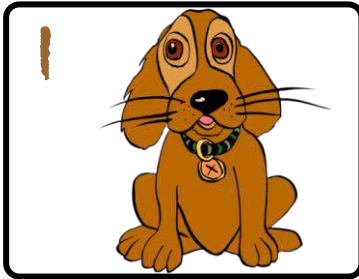

- a) dog
- b) lizard
- c) parrot
- d) duck

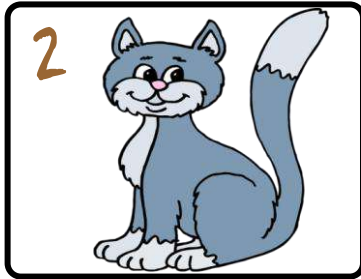

- a) canary
- b) snake
- c) frog
- d) cat

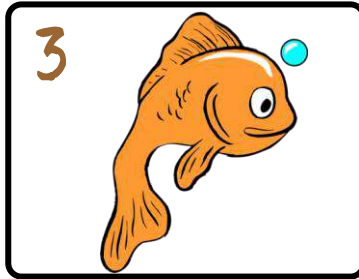

- a) rabbit
- b) hamster
- c) fish
- d) iguana

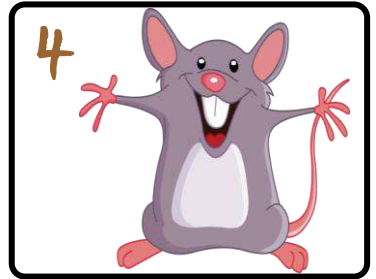

- a) turtle
- b) mouse
- c) chameleon
- d) pigeon



- a) mouse
- b) turtle
- c) canary
- d) frog



- a) hamster
- b) dog
- c) rabbit
- d) iguana

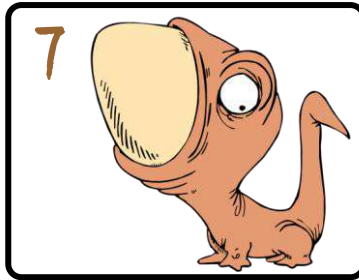

- a) cat
- b) lizard
- c) parrot
- d) pigeon

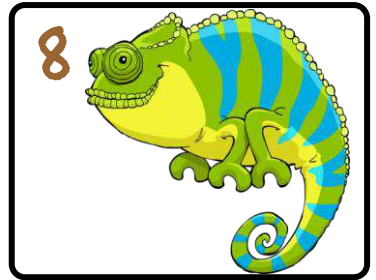

- a) chameleon
- b) fish
- c) snake
- d) duck

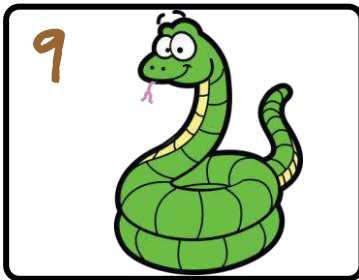

- a) duck
- b) mouse
- c) snake
- d) hamster



- a) canary
- b) parrot
- c) fish
- d) duck

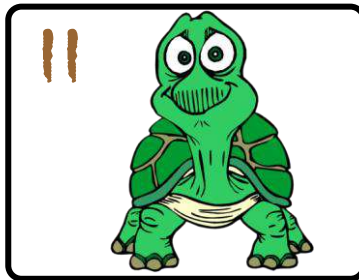

- a) iguana
- b) hamster
- c) dog
- d) turtle

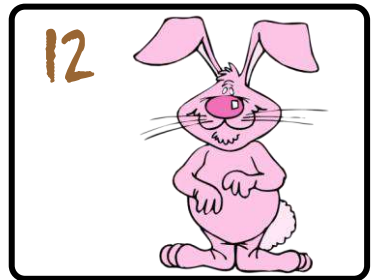

- a) lizard
- b) cat
- c) rabbit
- d) pigeon

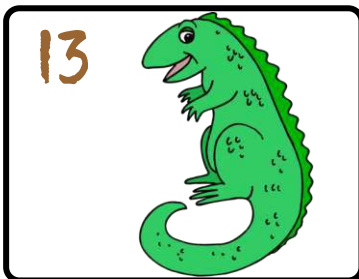

- a) cat
- b) iguana
- c) hamster
- d) rabbit

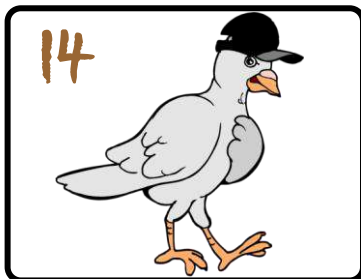

- a) snake
- b) lizard
- c) pigeon
- d) dog

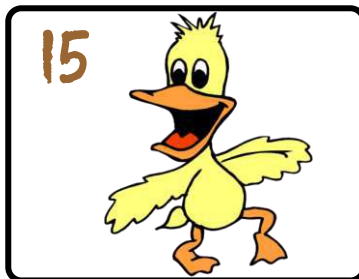

- a) mouse
- b) chameleon
- c) snake
- d) duck



- a) frog
- b) fish
- c) canary
- d) parrot

PETS MULTIPLE CHOICE TESTS ANSWER KEY

TEST 1

1) a

2) d

3) c

4) b

5) c

6) a

7) b

8) a

9) c

10) b

11) d

12) c

13) b

14) c

15) d

16) a

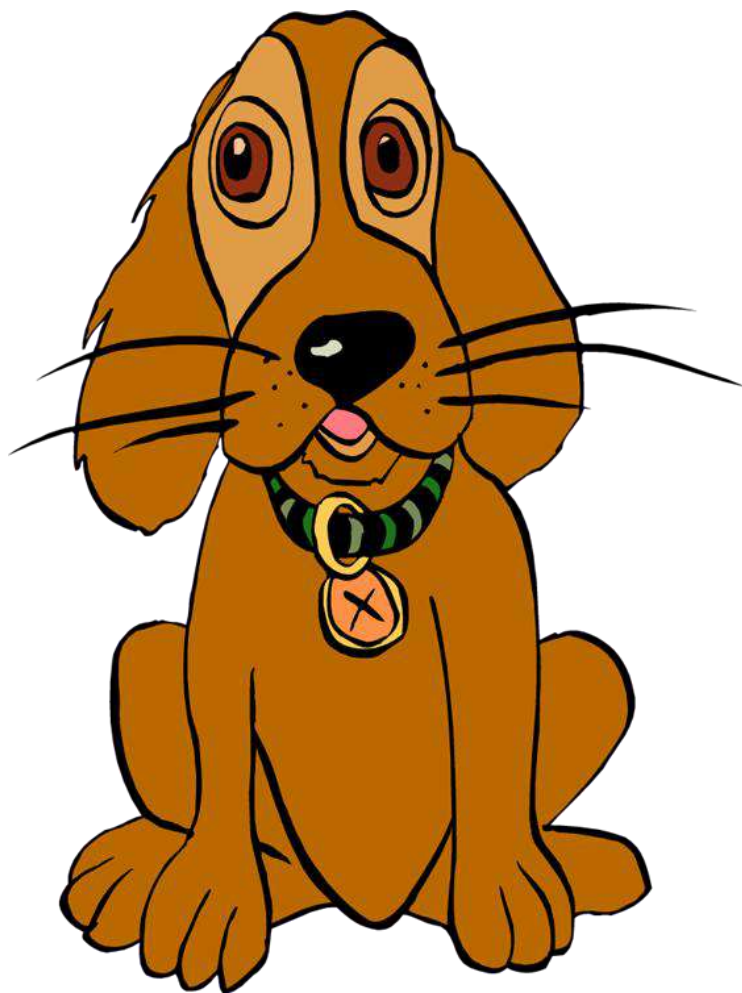

dog



cat

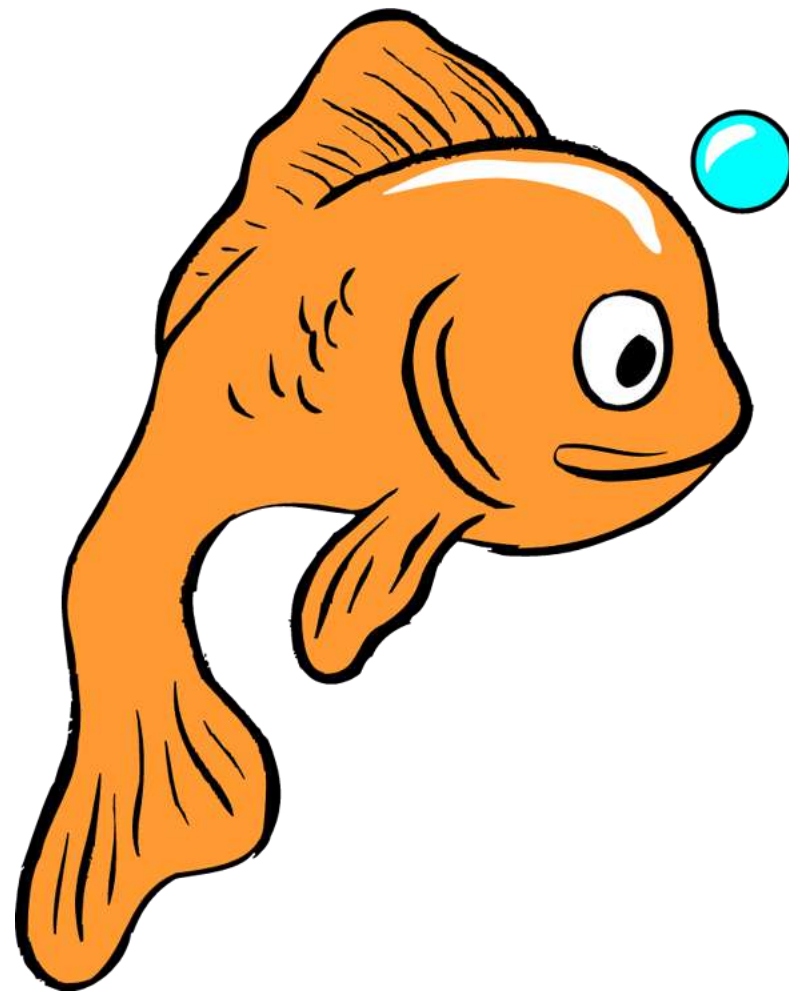

fish



mouse



canary



hamster

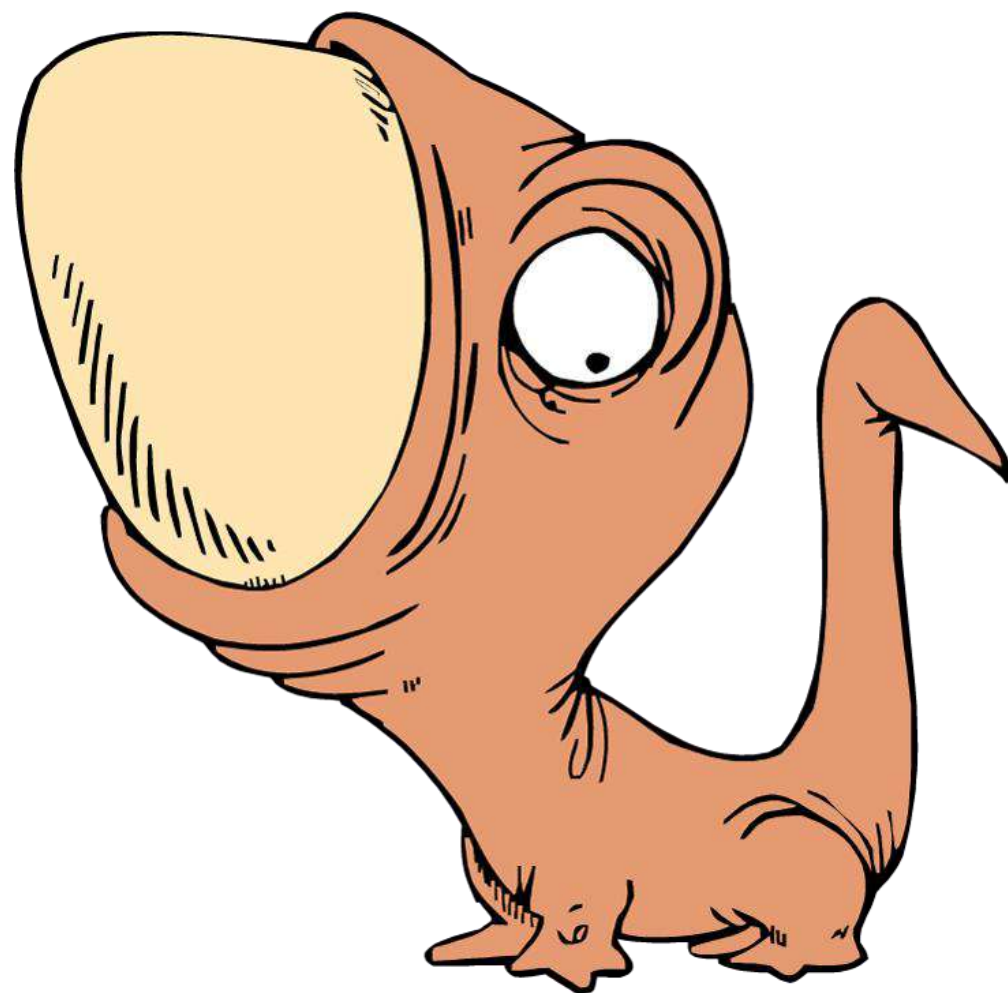

lizard



chameleon

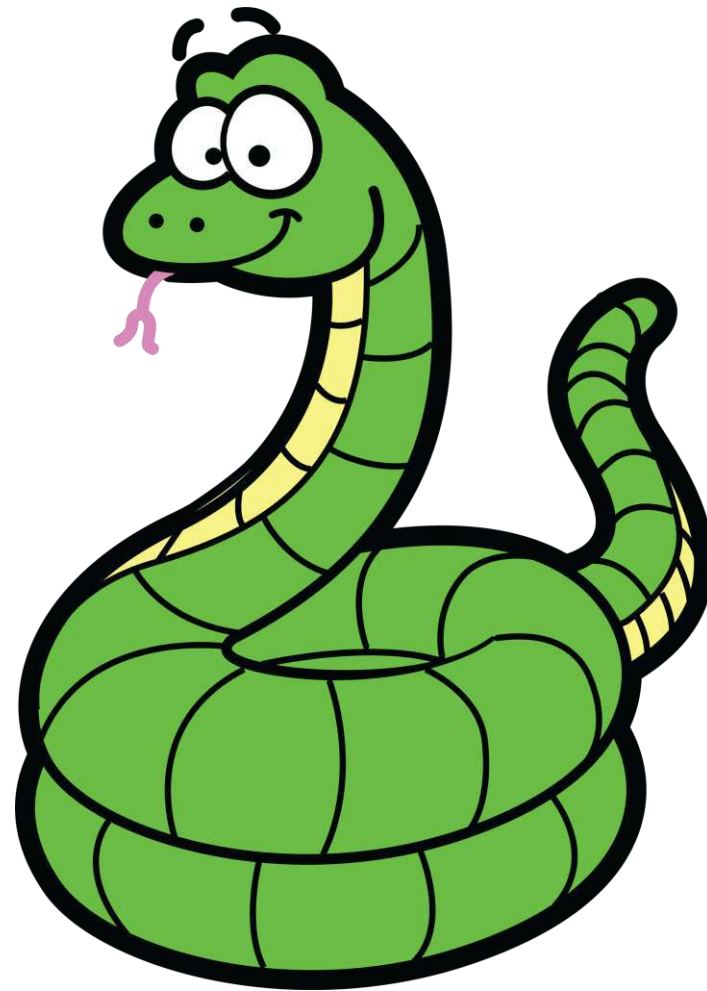

snake



parrot

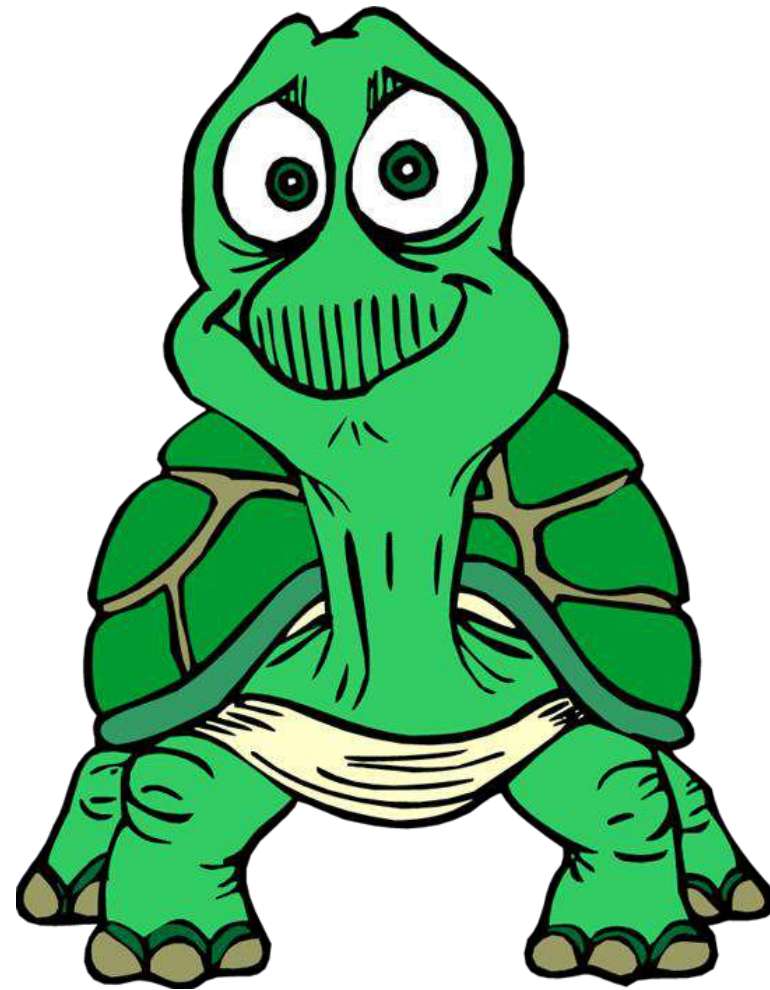

turtle

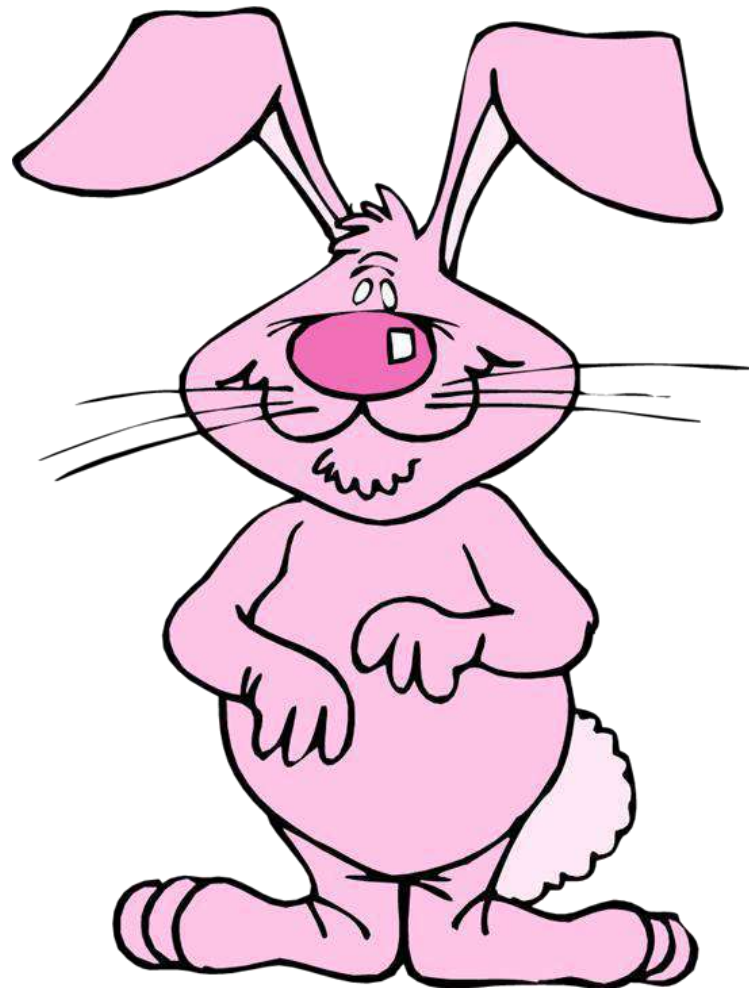

rabbit

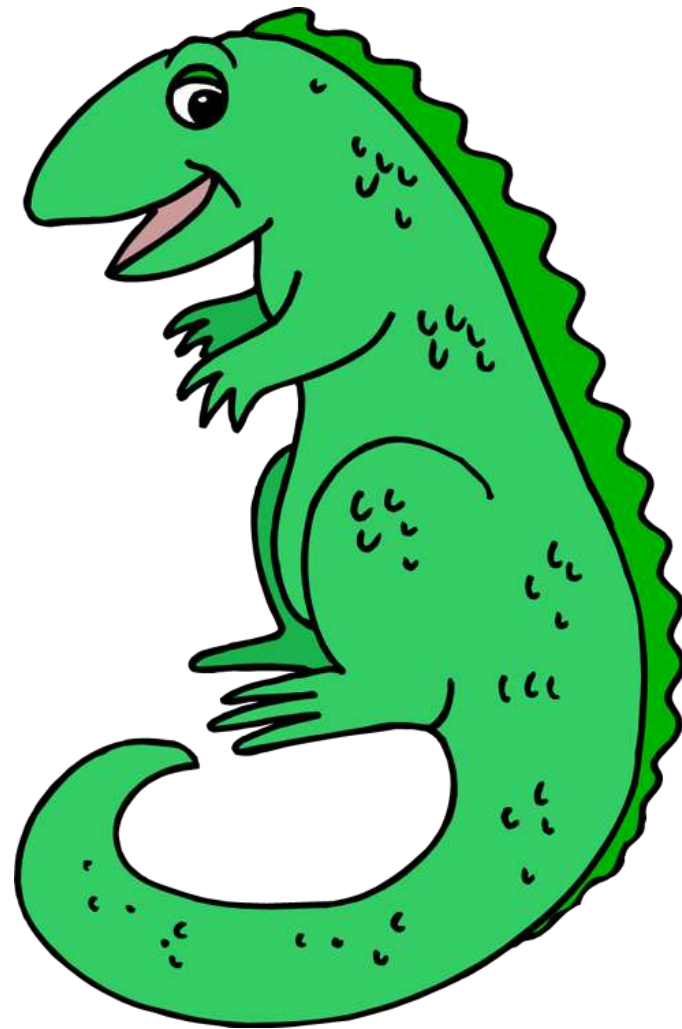

iguana

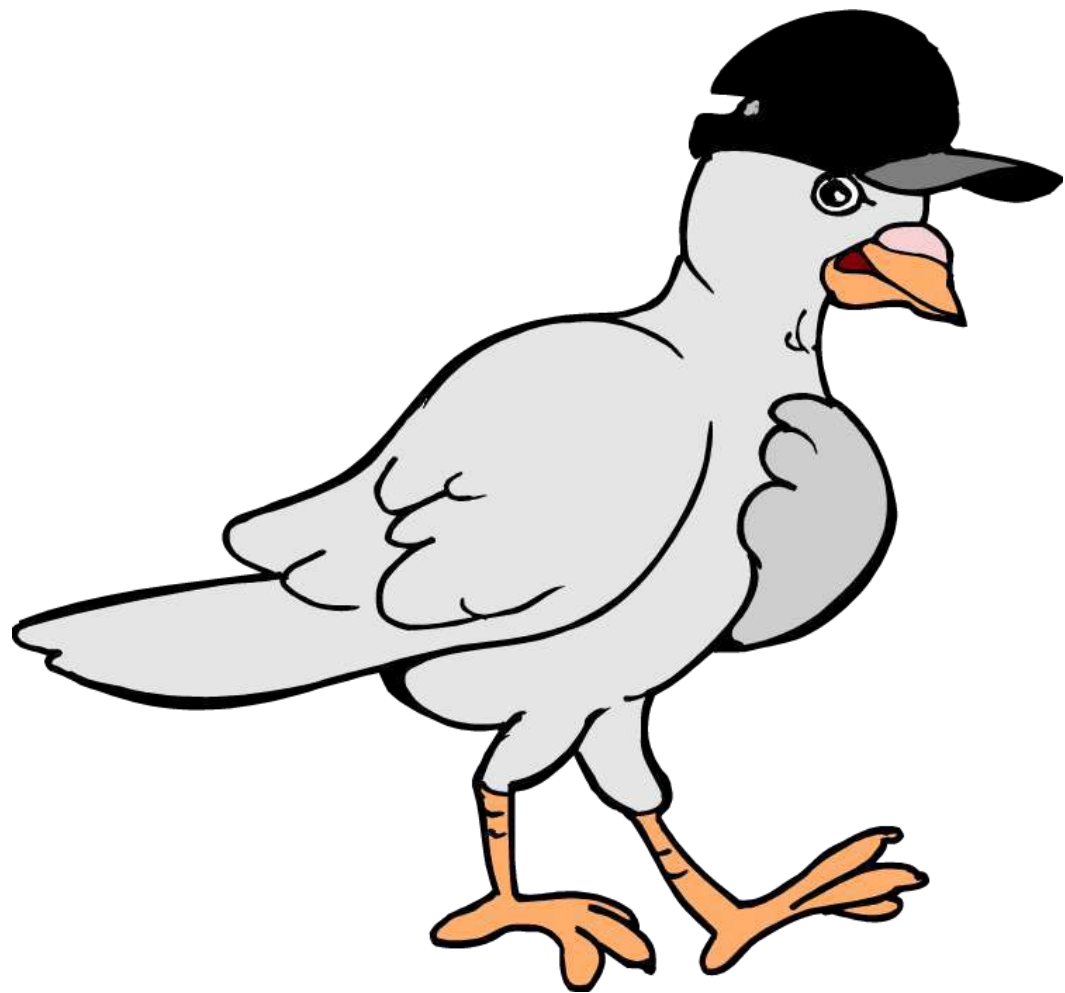

pigeon



duck



frog

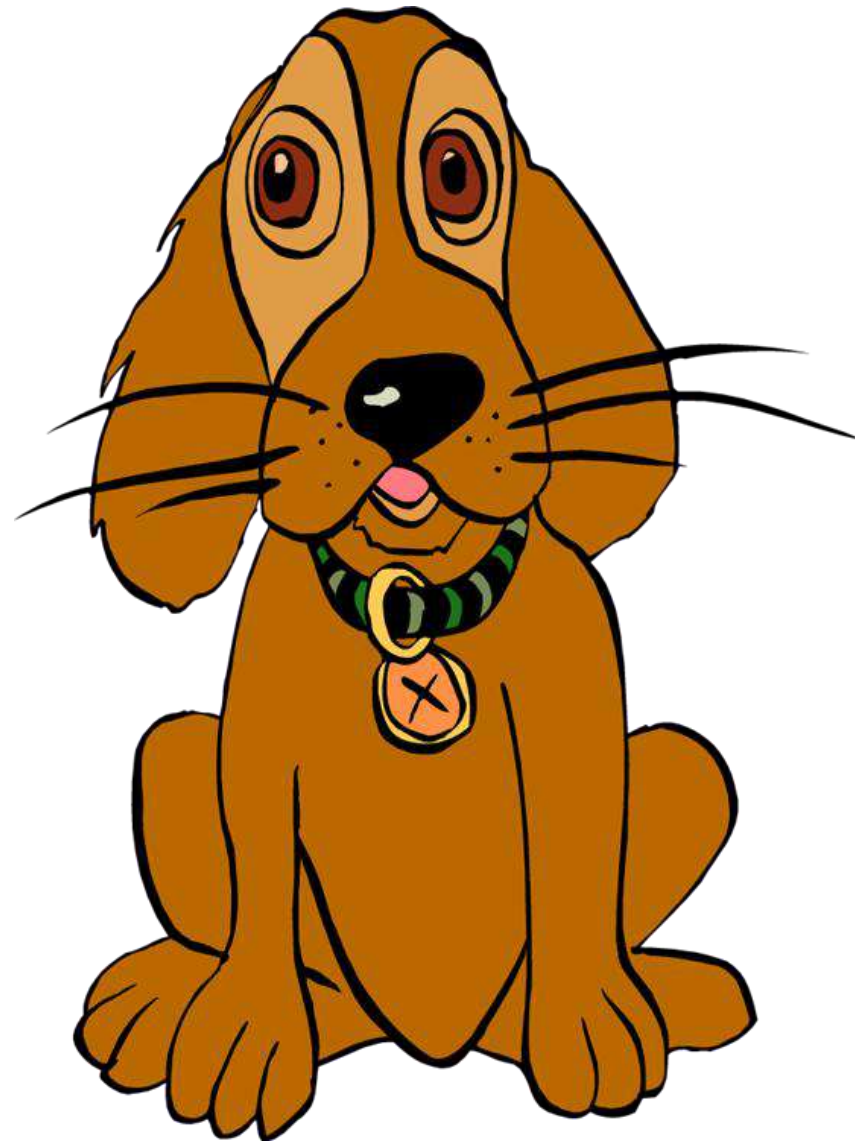

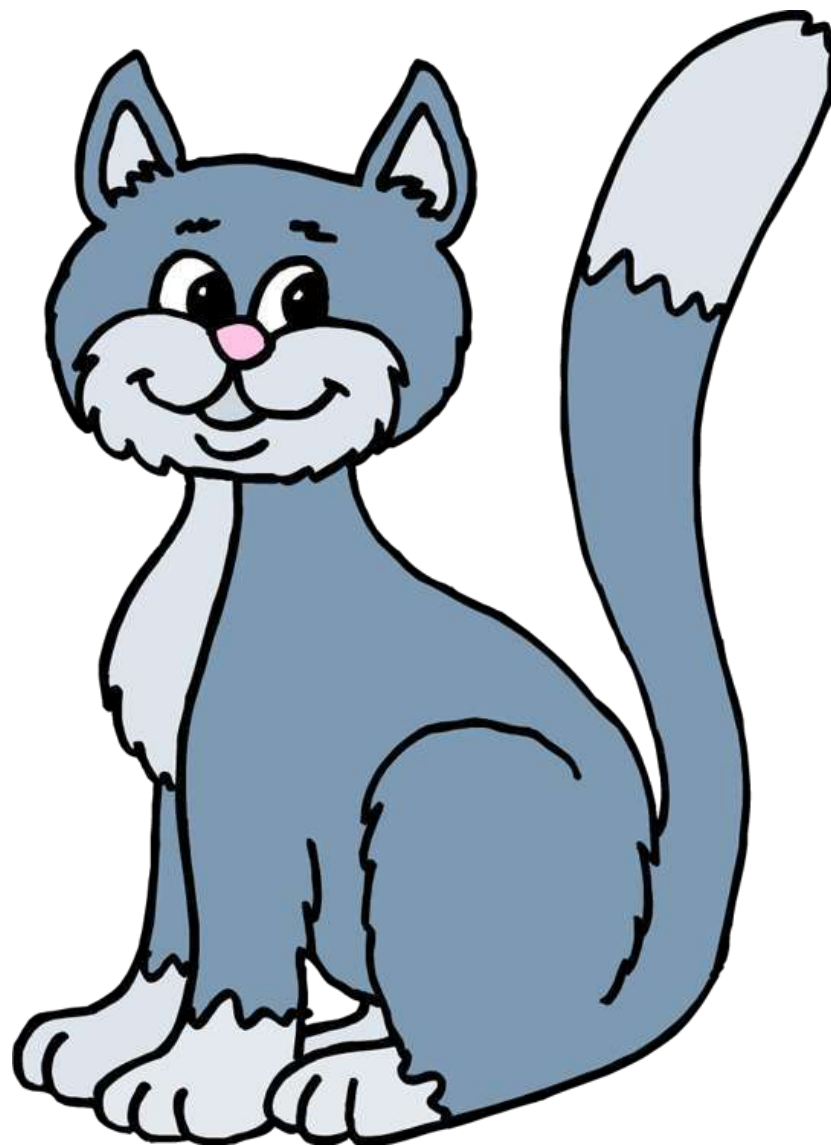

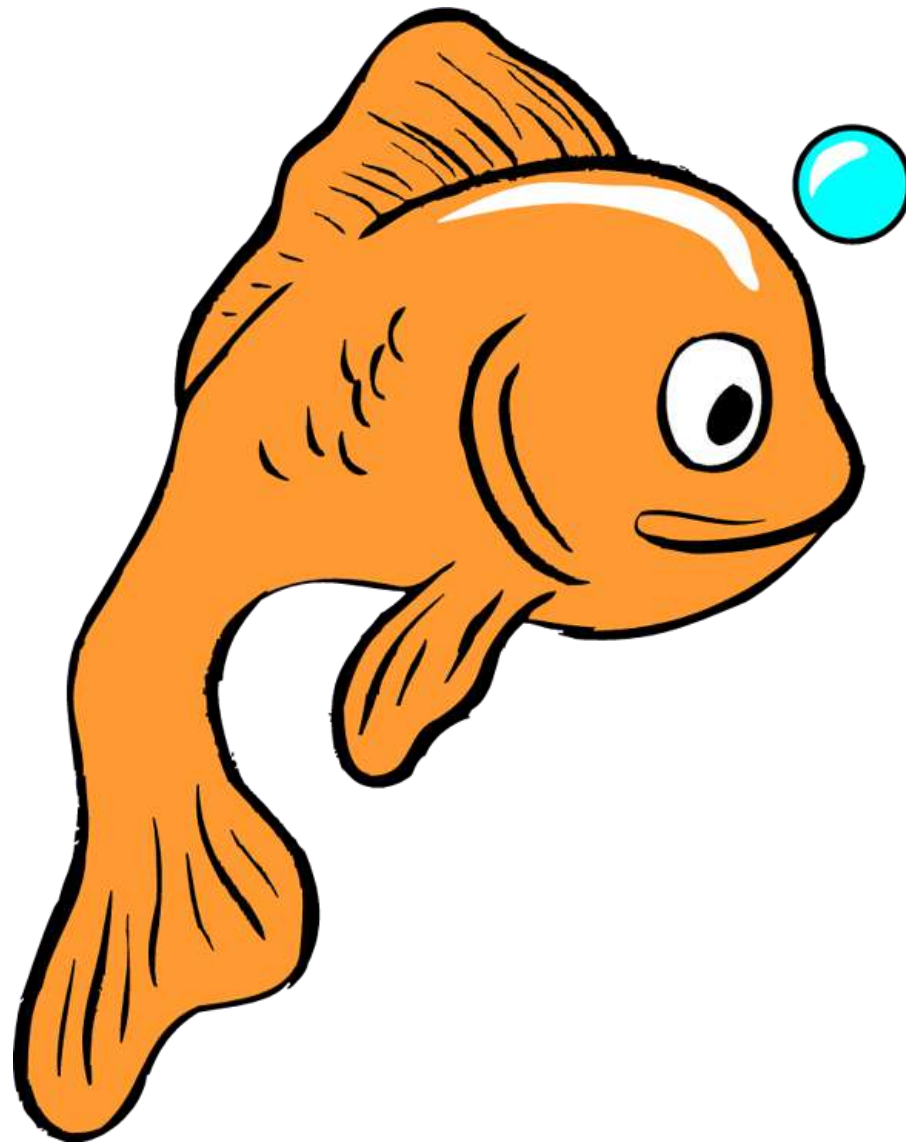







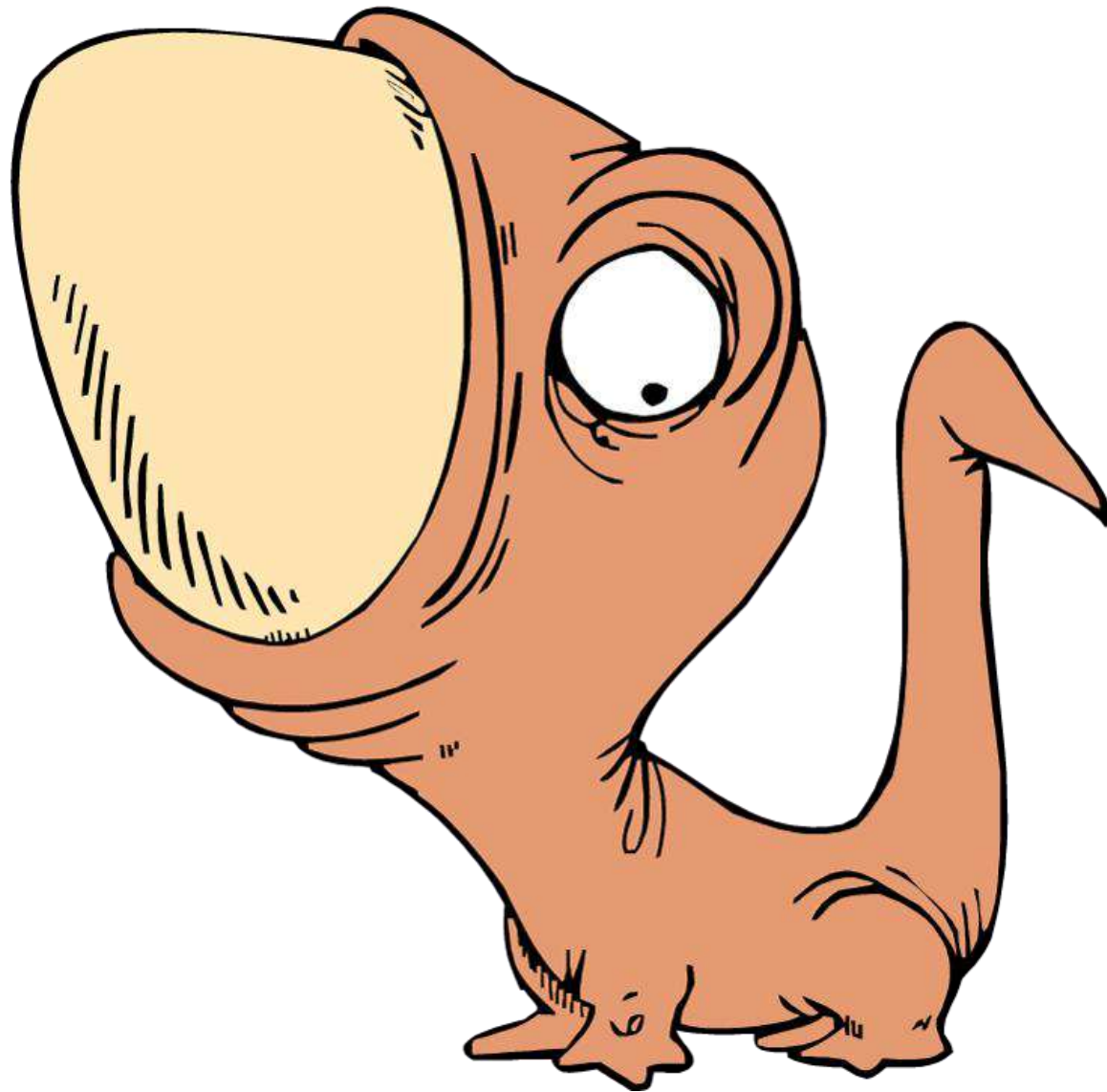



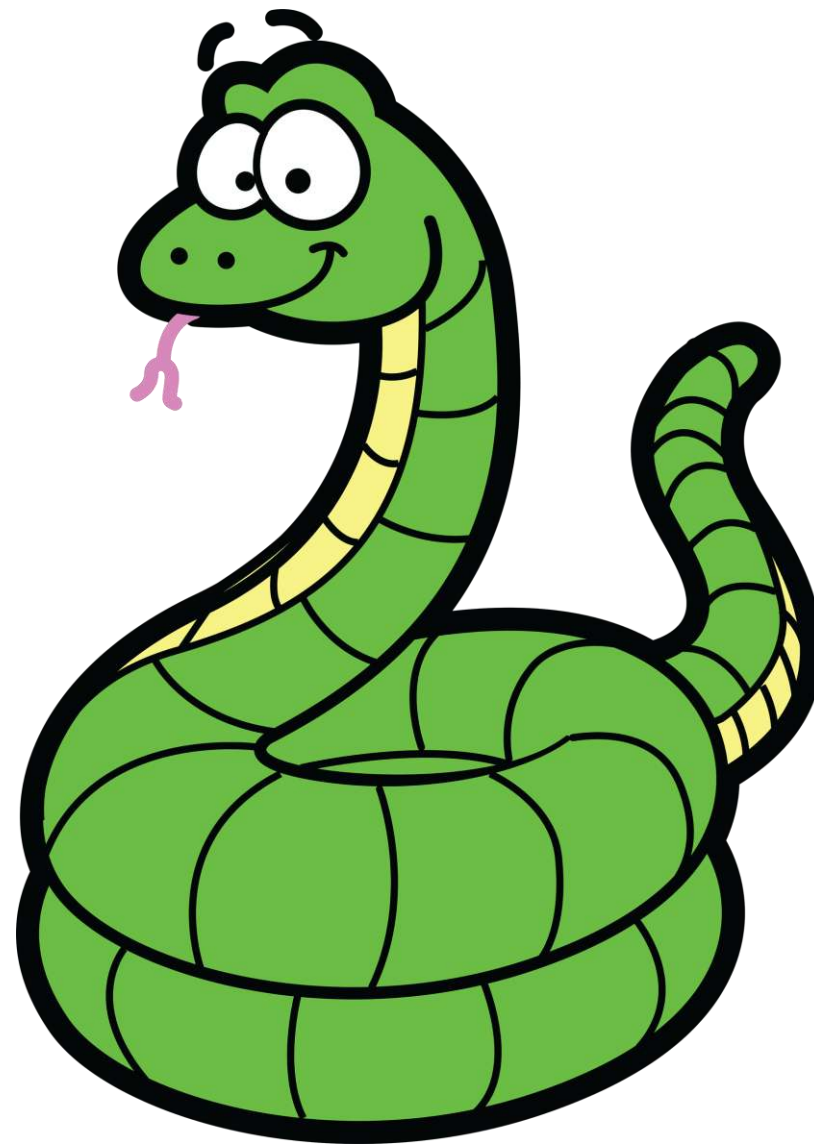



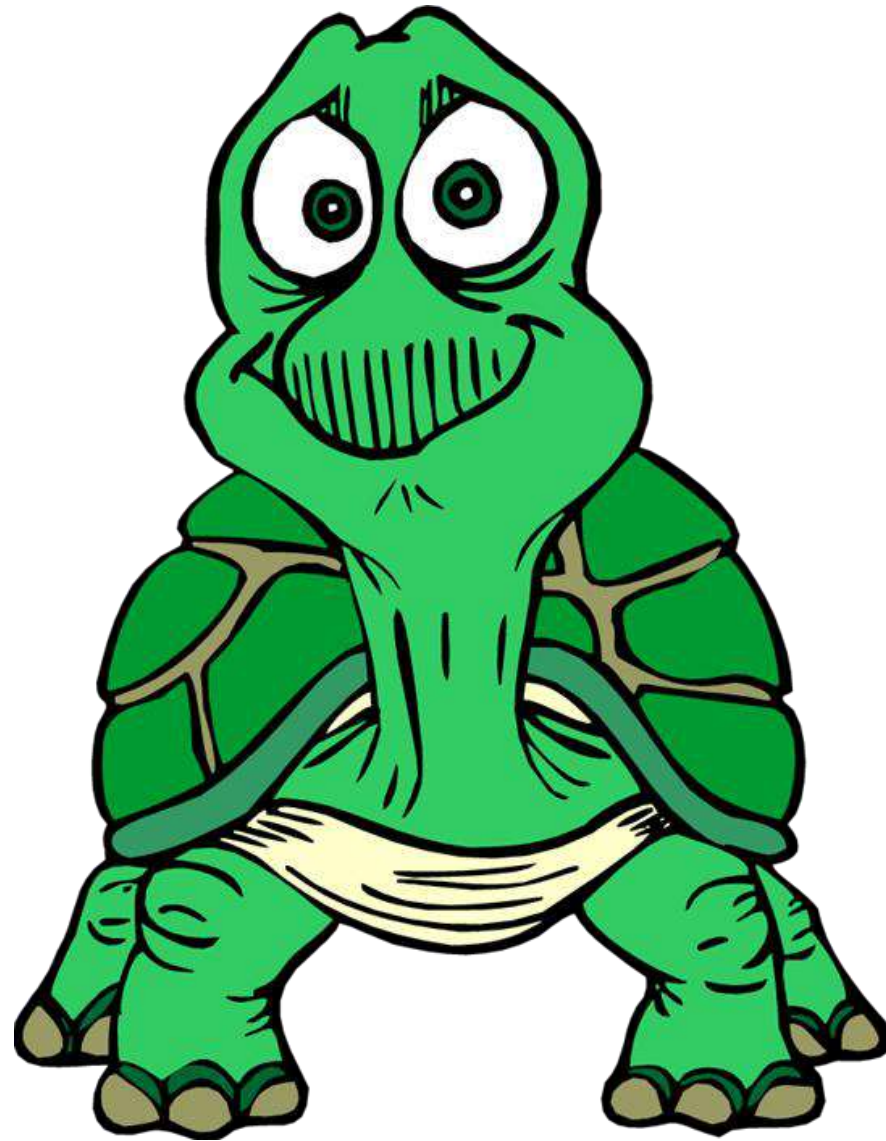

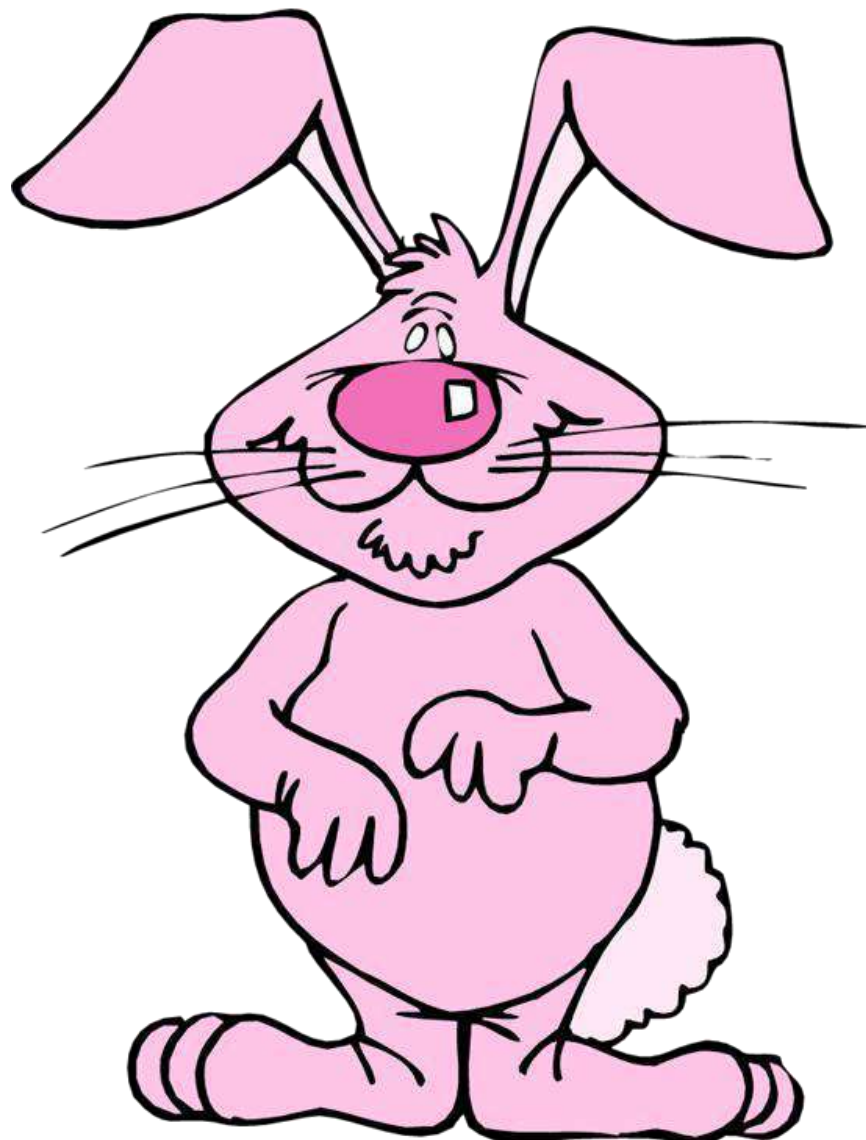

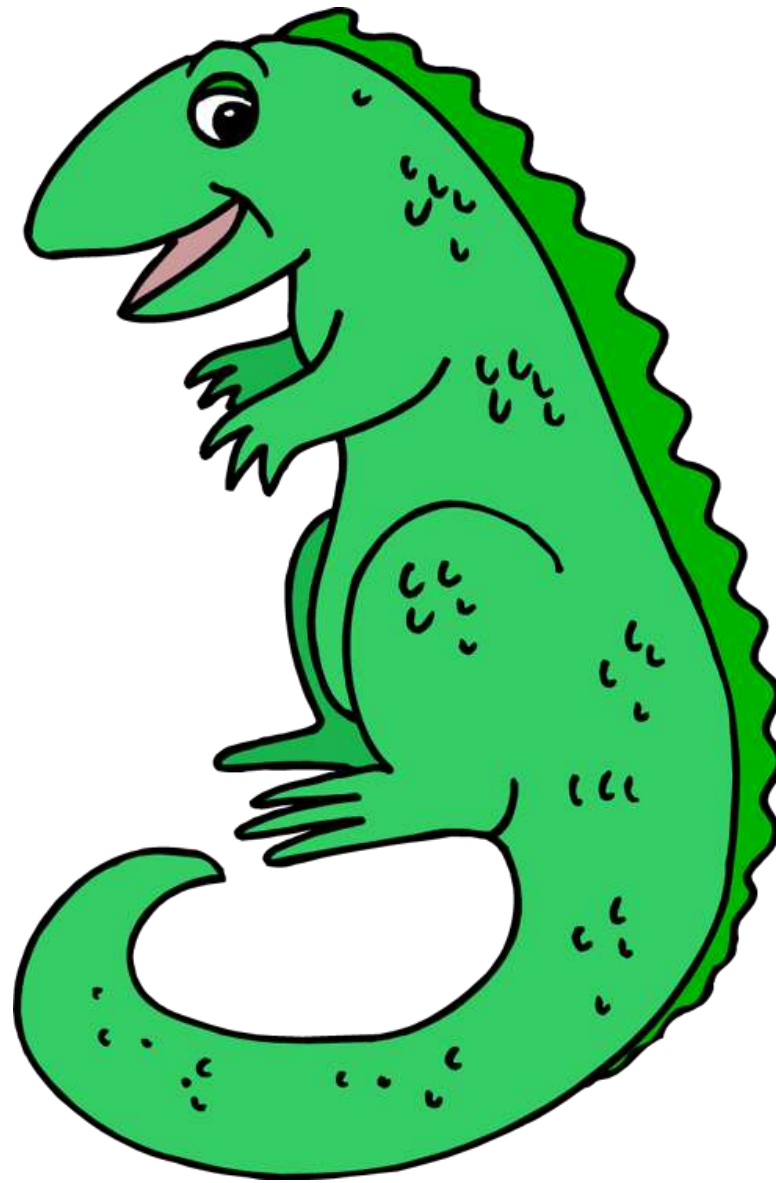

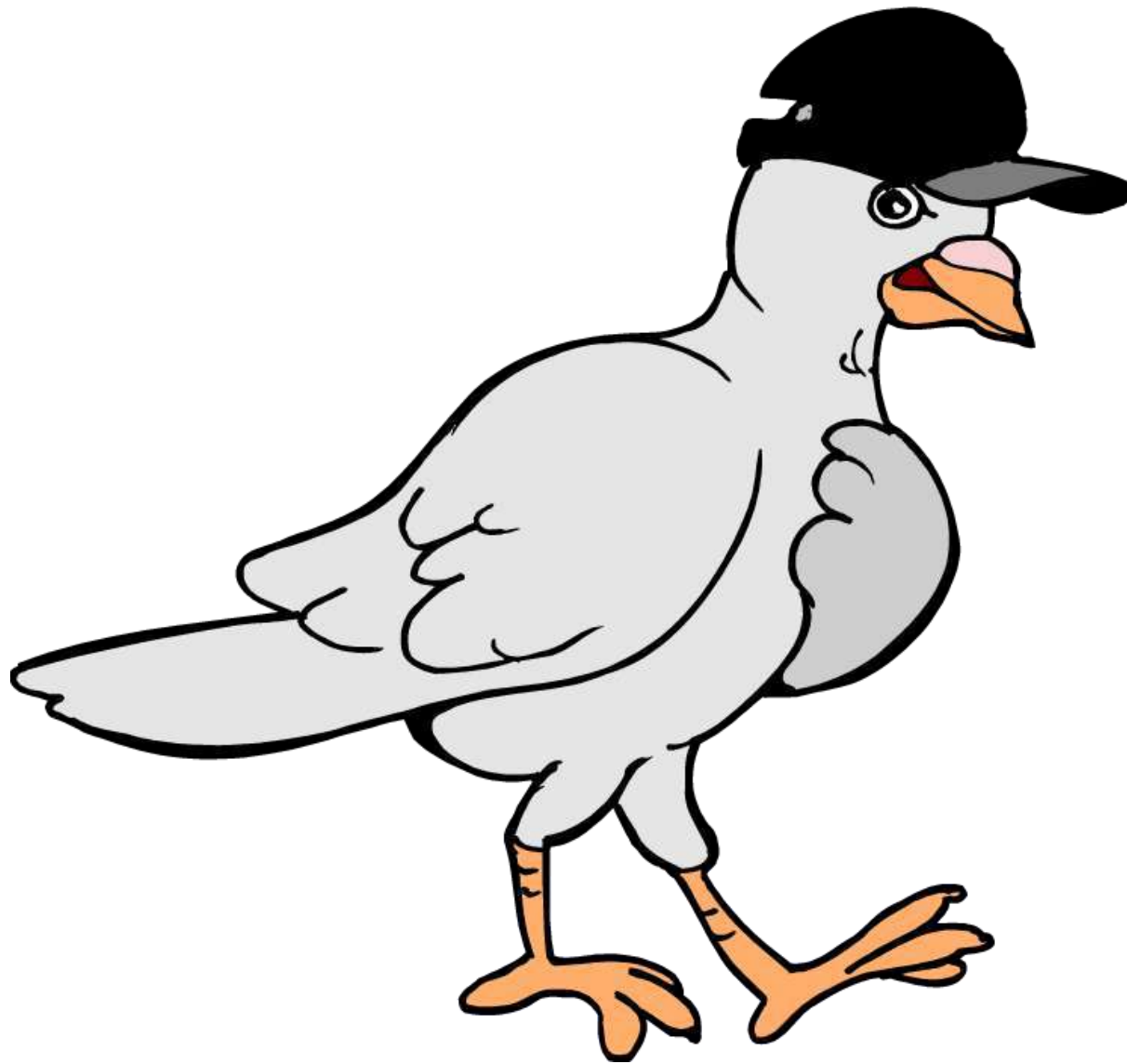





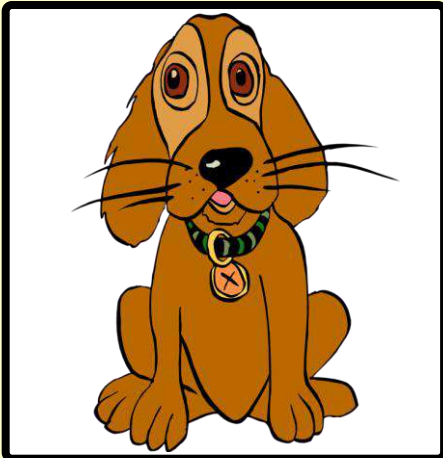

dog

Copyright © 12/11/2019 englishsheets.com. All rights reserved.

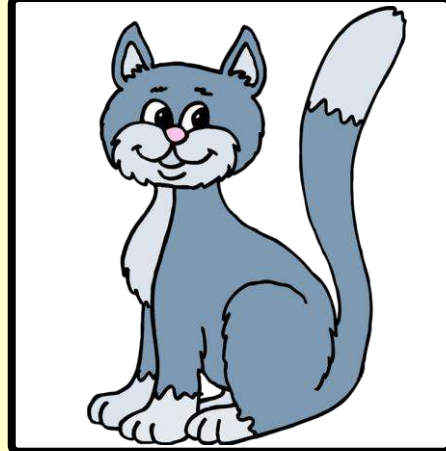

cat

Copyright © 12/11/2019 englishsheets.com. All rights reserved.

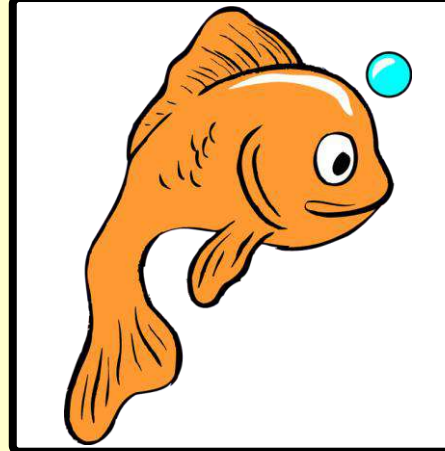

fish

Copyright © 12/11/2019 englishsheets.com. All rights reserved.



mouse

Copyright © 12/11/2019 englishsheets.com. All rights reserved.



canary

Copyright © 12/11/2019 englishsheets.com. All rights reserved.



hamster

Copyright © 12/11/2019 englishsheets.com. All rights reserved.

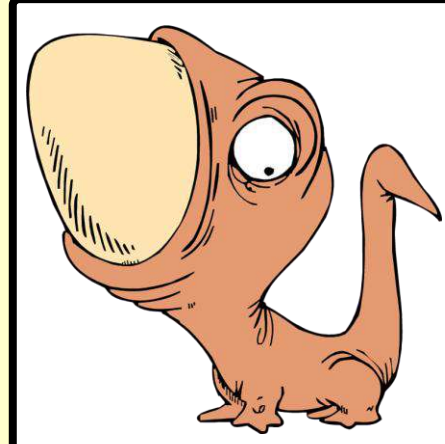

lizard

Copyright © 12/11/2019 englishsheets.com. All rights reserved.

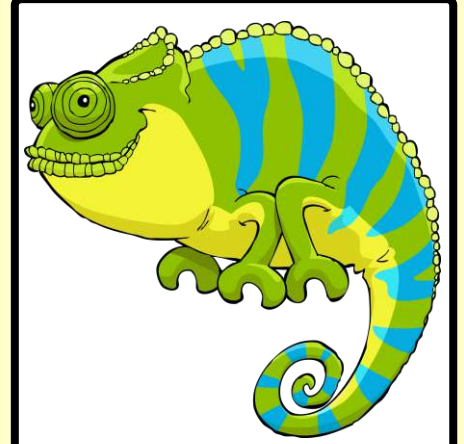

chamaleon

Copyright © 12/11/2019 englishsheets.com. All rights reserved.

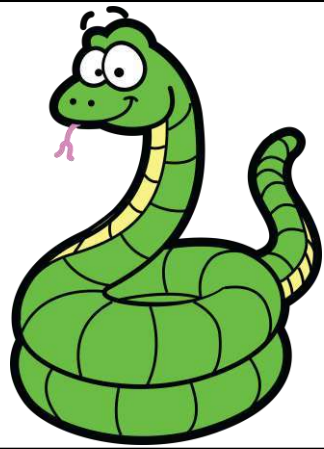

snake

Copyright © 12/11/2019 englishsheets.com. All rights reserved.



parrot

Copyright © 12/11/2019 englishsheets.com. All rights reserved.

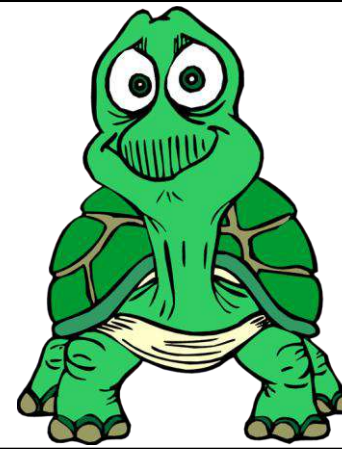

turtle

Copyright © 12/11/2019 englishsheets.com. All rights reserved.

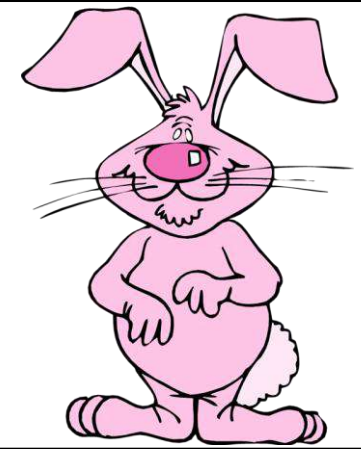

rabbit

Copyright © 12/11/2019 englishsheets.com. All rights reserved.

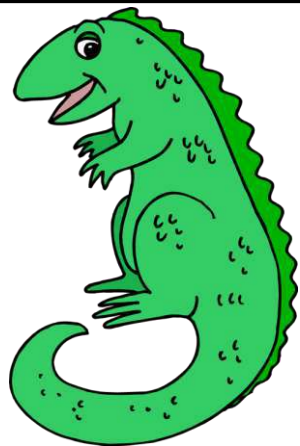

iguana

Copyright © 12/11/2019 englishsheets.com. All rights reserved.

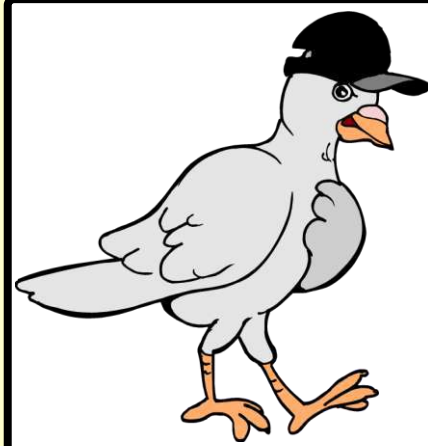

pigeon

Copyright © 12/11/2019 englishsheets.com. All rights reserved.



duck

Copyright © 12/11/2019 englishsheets.com. All rights reserved.

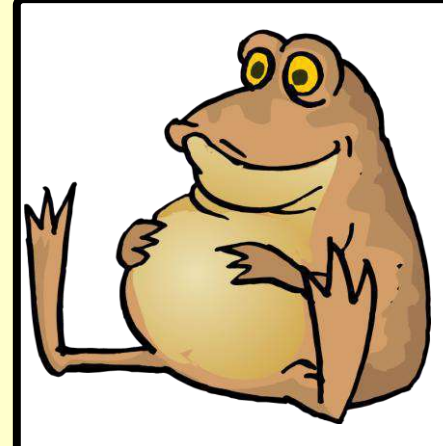

frog

Copyright © 12/11/2019 englishsheets.com. All rights reserved.

PETS FIDGET SPINNER GAME



- Cut a small arrow from paper or craft foam and stick it onto the fidget spinner as your pointer.
- Place the fidget spinner in the middle of the vocabulary circle.
- Spin it and say the word quickly!

PETS FIDGET SPINNER GAME

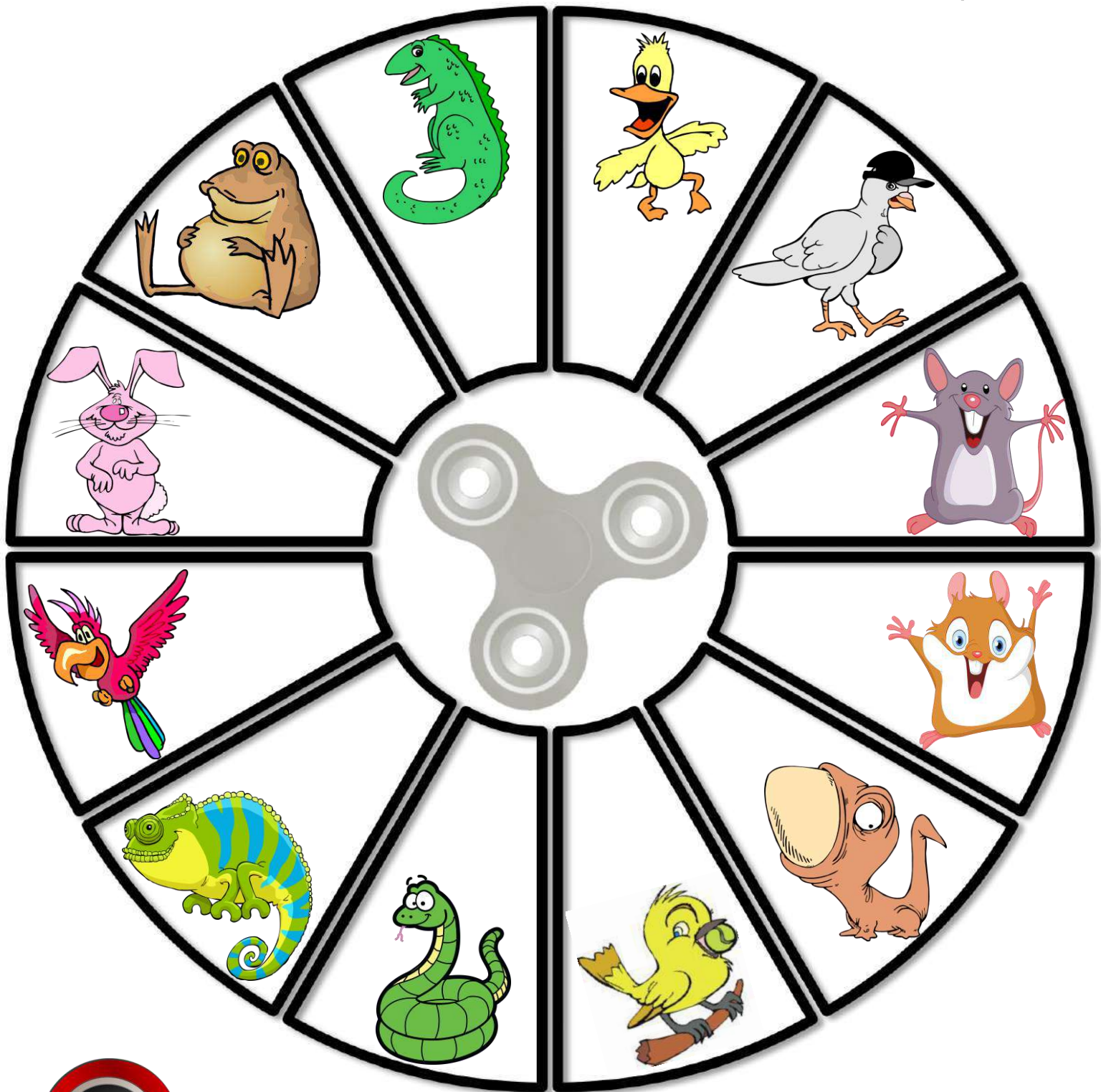

- Cut a small arrow from paper or craft foam and stick it onto the fidget spinner as your pointer.
- Place the fidget spinner in the middle of the vocabulary circle.
- Spin it and say the word quickly!

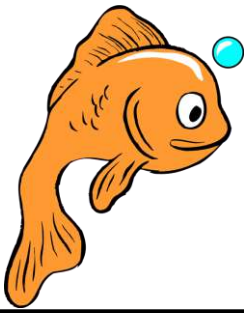

dog



cat



fish

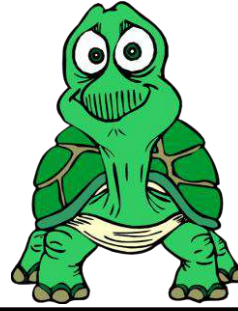

mouse

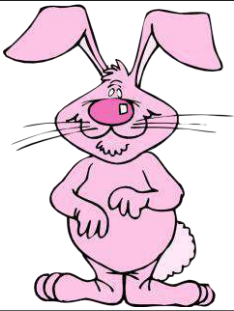

canary

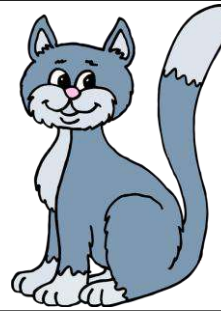

hamster

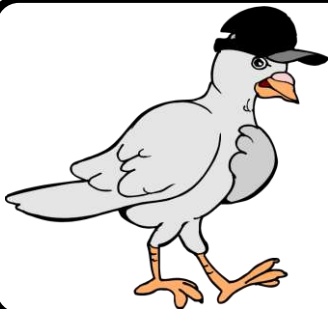

lizard



chameleon

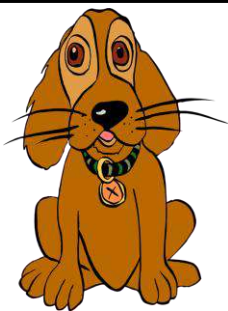

snake

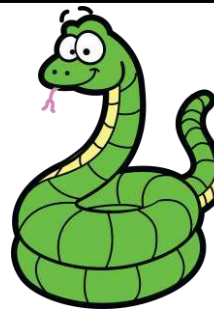

parrot



turtle



rabbit



iguana

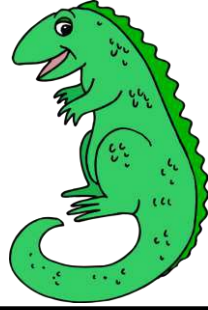

pigeon

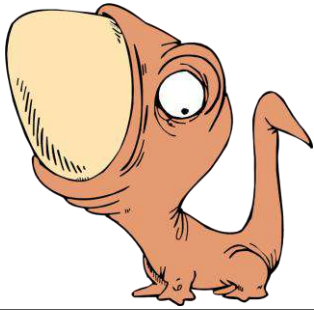

duck



frog

PLACES IN A CITY PICTURE DICTIONARY !



bank



airport



museum



hospital



supermarket

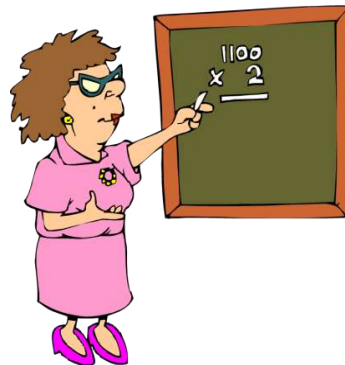

school



fire station



hotel

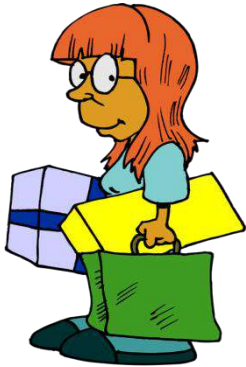

mall



cafe



bus stop



police station



restaurant



butcher's



bakery



park

PLACES IN A CITY PICTURE DICTIONARY 2



petrol station

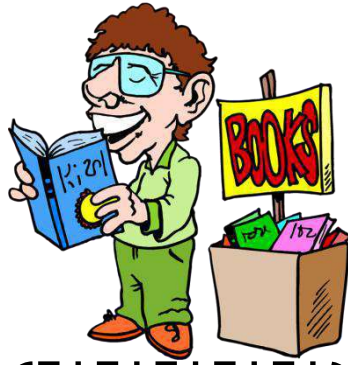

bookshop



court



gallery



prison



greengrocer's



hairdresser's

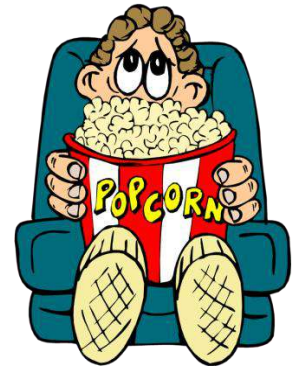

cinema



florist's

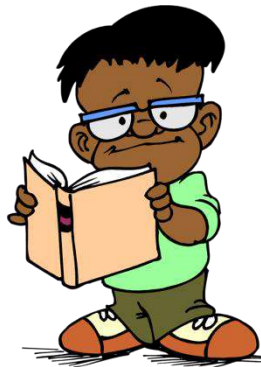

library



train station



post office



zoo



pharmacy



gym



theatre

PLACES IN A CITY PICTURE DICTIONARY 1



bank



airport



museum



hospital



supermarket

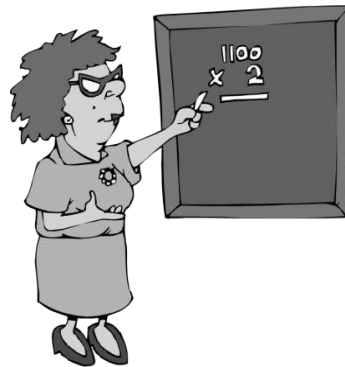

school



fire station



hotel



mall



cafe



bus stop



police station



restaurant



butcher's



bakery



park

PLACES IN A CITY PICTURE DICTIONARY 2



petrol station



bookshop



court



gallery



prison



greengrocer's



hairdresser's



cinema



florist's



library



train station



post office



zoo



pharmacy



gym



theatre

PLACES IN A CITY VOCABULARY MATCHING WORKSHEET !

Choose the correct words from the list below and write them under the correct pictures



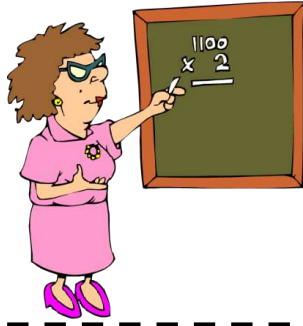

WORD LIST

- bank
- airport
- museum
- hospital
- supermarket
- school
- fire station
- hotel
- mall
- cafe
- bus stop
- police station
- restaurant
- butcher's
- bakery
- park



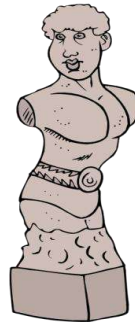



PLACES IN A CITY VOCABULARY MATCHING WORKSHEET 2

Choose the correct words from the list below and write them under the correct pictures





WORD LIST

- petrol station
- bookshop
- court
- gallery
- prison
- greengrocer's
- hairdresser's
- cinema
- florist's
- library
- train station
- post office
- zoo
- pharmacy
- gym
- theatre



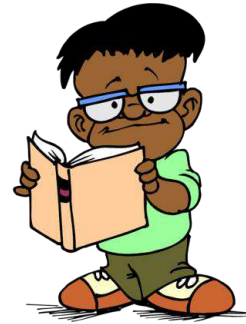



PLACES IN A CITY VOCABULARY MATCHING WORKSHEET | ANSWER KEY

Choose the correct words from the list below and write them under the correct pictures



police station



hospital



supermarket



park



bus stop

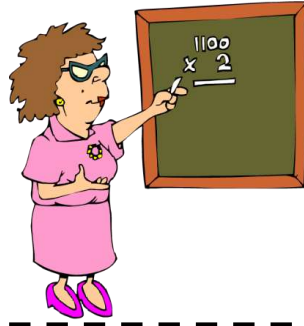

school

WORD LIST

- bank
- airport
- museum
- hospital
- supermarket
- school
- fire station
- hotel
- mall
- cafe
- bus stop
- police station
- restaurant
- butcher's
- bakery
- park



butcher's



bank



hotel



bakery



museum



cafe



mall



airport



restaurant



fire station

PLACES IN A CITY VOCABULARY MATCHING WORKSHEET 2 ANSWER KEY

Choose the correct words from the list below and write them under the correct pictures



florist's



court

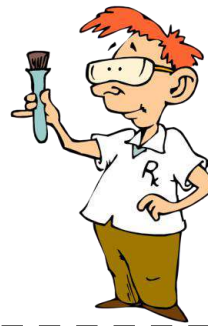

pharmacy



hairdresser's



petrol station



post office

WORD LIST

- petrol station
- bookshop
- court
- gallery
- prison
- greengrocer's
- hairdresser's
- cinema
- florist's
- library
- train station
- post office
- zoo
- pharmacy
- gym
- theatre



greengrocer's



theatre



gallery



zoo



prison

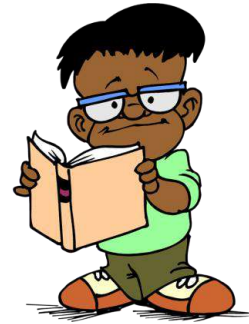

library



cinema



gym



bookshop



train station

PLACES IN A CITY WORD SEARCH PUZZLE !

Find and circle the words in the word search puzzle and number the pictures

h	m	b	a	i	r	p	o	r	t	w	o	v	x	f
h	j	a	h	o	s	p	i	t	a	l	b	n	k	i
k	s	n	r	q	c	b	m	u	s	e	u	m	b	n
f	o	k	j	r	h	u	a	c	g	e	s	o	z	b
i	w	f	v	v	o	t	l	t	q	b	s	t	l	a
r	k	h	h	z	o	c	l	e	k	l	t	v	q	k
e	q	b	o	z	l	h	w	a	u	u	o	v	l	e
s	h	g	k	v	w	e	j	d	l	o	p	o	b	r
t	o	s	u	p	e	r	m	a	r	k	e	t	k	y
a	k	a	l	z	f	s	m	g	k	s	m	n	k	a
t	d	p	o	l	i	c	e	s	t	a	t	i	o	n
i	a	t	h	h	o	t	e	l	s	p	a	r	k	w
o	i	d	k	d	d	c	a	f	e	n	p	c	k	k
n	w	b	o	z	r	e	s	t	a	u	r	a	n	t
s	b	y	s	b	t	i	b	c	k	p	q	j	d	u

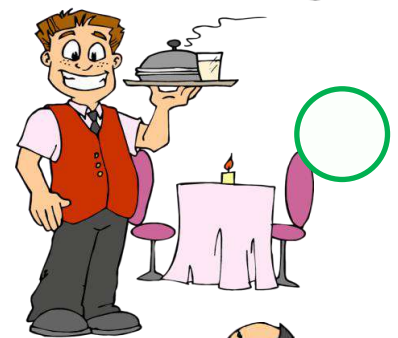
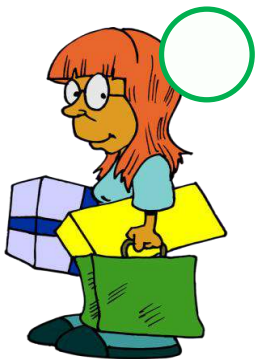
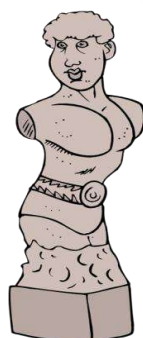
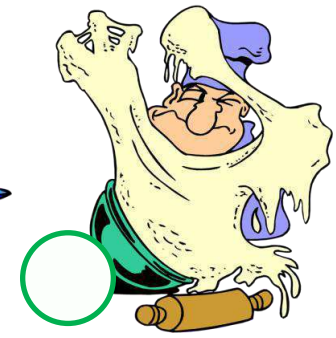
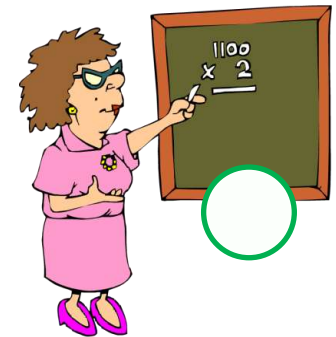
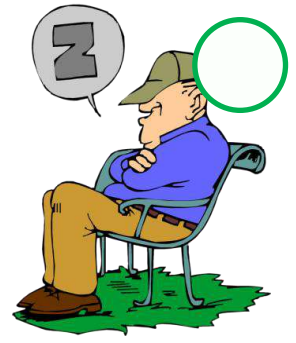

1. bank
2. airport
3. museum
4. hospital
5. supermarket
6. school
7. fire station
8. hotel
9. mall
10. cafe
11. bus stop
12. police station
13. restaurant
14. butcher's
15. bakery
16. park

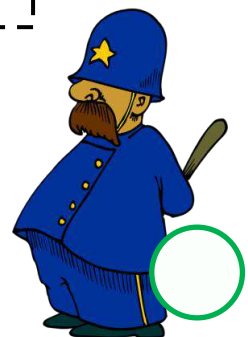
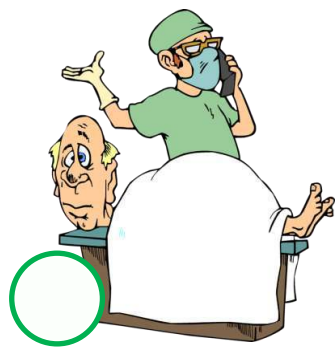

PLACES IN A CITY WORD SEARCH PUZZLE 2

Find and circle the words in the word search puzzle and number the pictures

g	f	b	f	w	u	t	h	b	q	l	l	c	g	y
d	l	c	i	n	e	m	a	j	l	h	d	n	r	t
p	o	l	e	s	v	m	i	i	i	v	p	e	h	
e	r	d	f	g	j	y	r	g	b	c	t	o	e	e
t	i	w	p	r	b	c	d	a	r	p	s	s	n	a
r	s	s	t	p	o	o	r	l	a	c	j	t	g	t
o	t	g	z	o	o	u	e	l	r	t	f	o	r	r
l	s	y	a	j	k	r	s	e	y	n	r	f	o	e
s	m	m	o	b	s	t	s	r	n	c	p	f	c	l
t	u	h	e	n	h	z	e	y	o	m	f	i	e	n
a	p	r	i	s	o	n	r	q	s	s	n	c	r	a
t	g	i	d	t	p	j	s	d	s	g	d	e	s	z
i	q	t	b	n	d	i	a	p	y	w	c	w	z	g
o	l	t	r	a	i	n	s	t	a	t	i	o	n	t
n	w	p	x	s	r	k	p	h	a	r	m	a	c	y

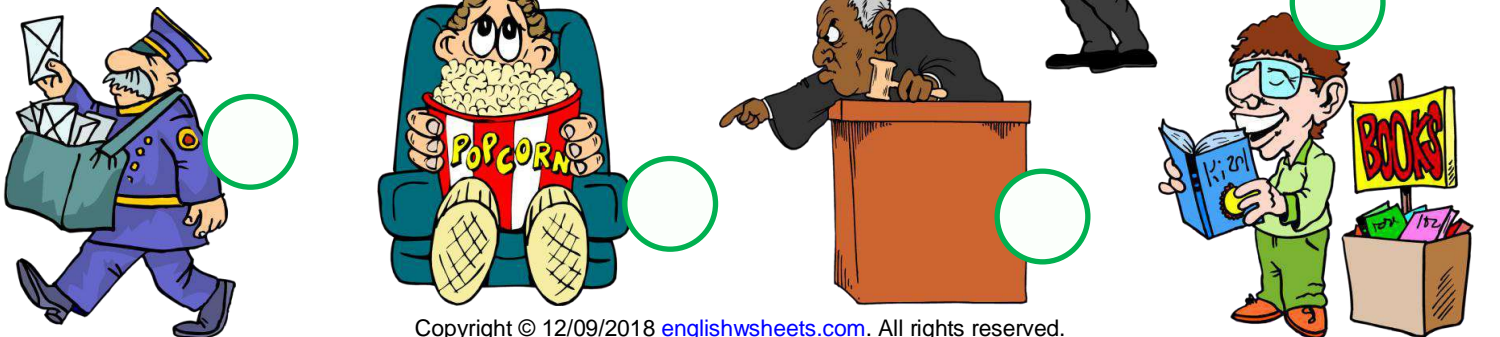
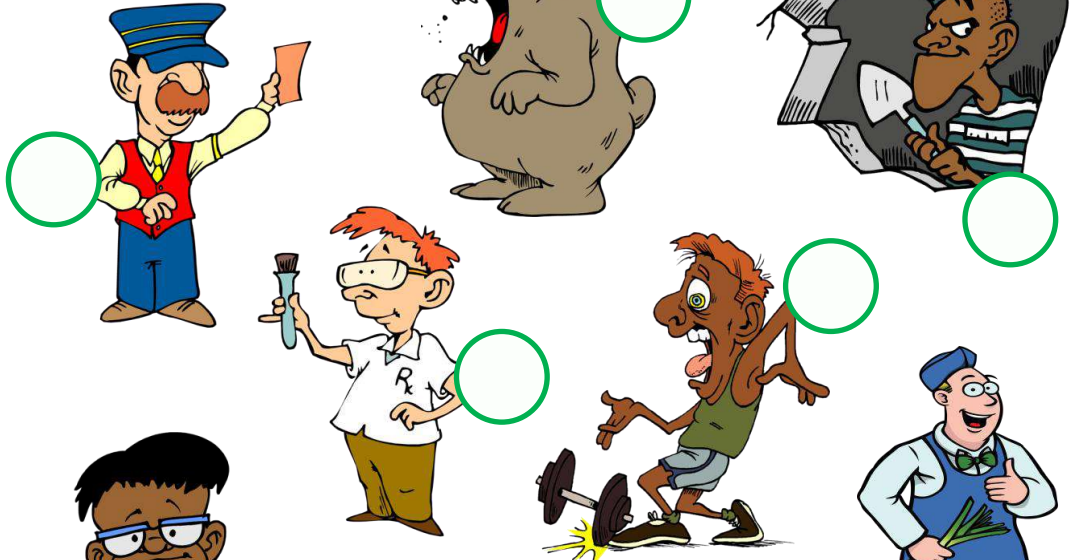
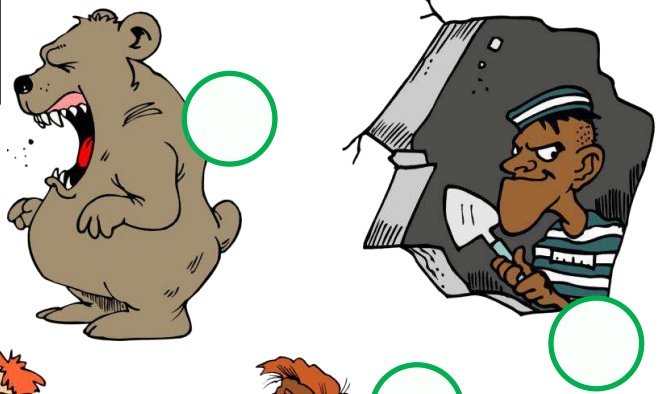
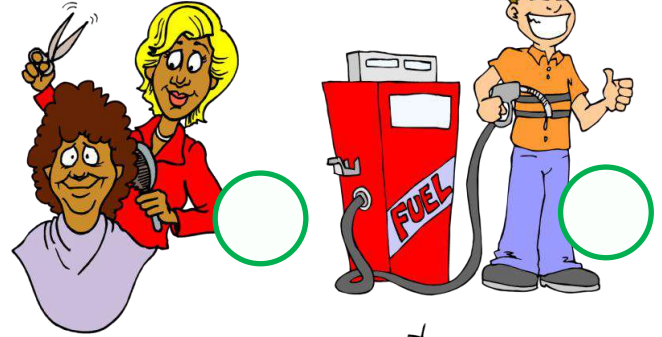
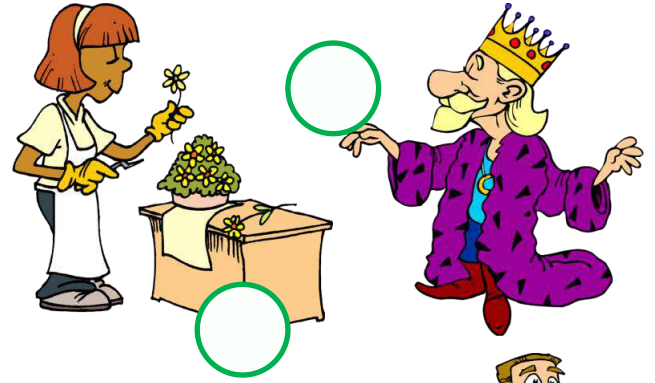

1. petrol station
2. bookshop
3. court
4. gallery
5. prison
6. greengrocer's
7. hairdresser's
8. cinema
9. florist's
10. library
11. train station
12. post office
13. zoo
14. pharmacy
15. gym
16. theatre

PLACES IN A CITY WORD SEARCH PUZZLE | ANSWER KEY

Find and circle the words in the word search puzzle and number the pictures

h	m	b	a	i	r	p	o	r	t	w	o	v	x	f
h	j	a	h	o	s	p	i	t	a	l	b	n	k	i
k	s	n	r	q	c	b	m	u	s	e	u	m	b	n
f	o	k	j	r	h	u	a	c	g	e	s	o	z	b
i	w	f	v	v	o	t	l	t	q	b	s	t	l	a
r	k	h	h	z	o	c	l	e	k	l	t	v	q	k
e	q	b	o	z	l	h	w	a	u	u	o	v	l	e
s	h	g	k	v	w	e	j	d	l	o	p	o	b	r
t	o	s	u	p	e	r	m	a	r	k	e	t	k	y
a	k	a	l	z	f	s	m	g	k	s	m	n	k	a
t	d	p	o	l	i	c	e	s	t	a	t	i	o	n
i	a	t	h	h	o	t	e	l	s	p	a	r	k	w
o	i	d	k	d	d	c	a	f	e	n	p	c	k	k
n	w	b	o	z	r	e	s	t	a	u	r	a	n	t
s	b	y	s	b	t	i	b	c	k	p	q	j	d	u

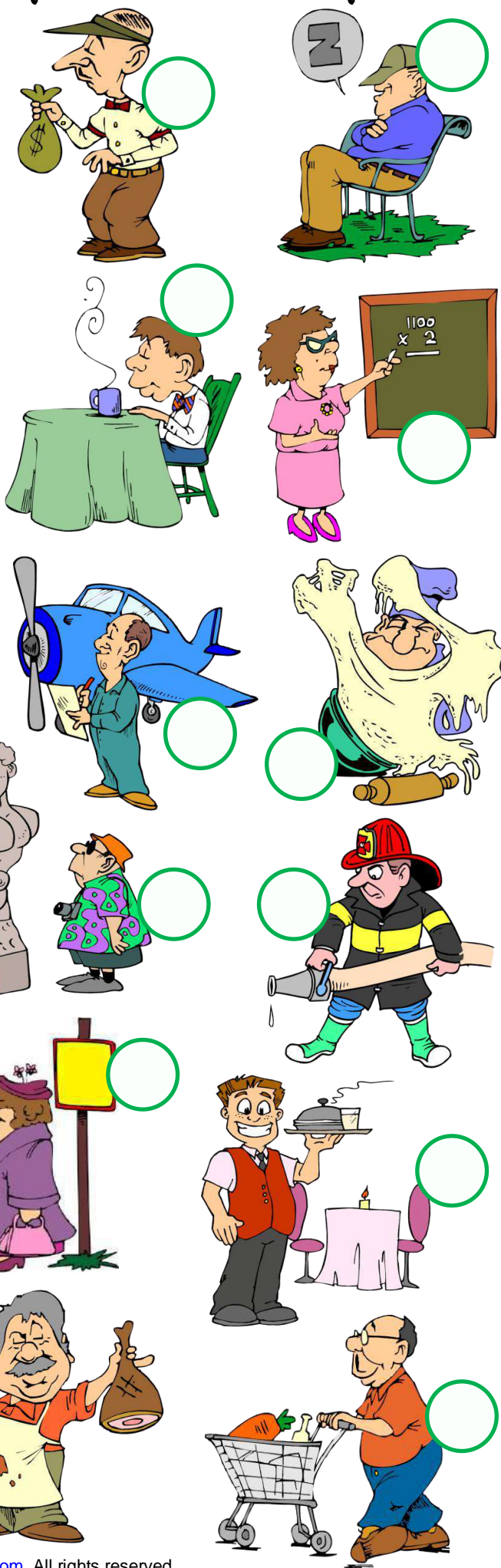

1. bank
2. airport
3. museum
4. hospital
5. supermarket
6. school
7. fire station
8. hotel
9. mall
10. cafe
11. bus stop
12. police station
13. restaurant
14. butcher's
15. bakery
16. park

PLACES IN A CITY WORD SEARCH PUZZLE 2 ANSWER KEY

Find and circle the words in the word search puzzle and number the pictures

g	f	b	f	w	u	t	h	b	q	l	l	c	g	y
d	l	c	i	n	e	m	a	j	l	h	d	n	r	t
p	o	l	e	s	v	m	i	i	i	i	v	p	e	h
e	r	d	f	g	j	y	r	g	b	c	t	o	e	e
t	i	w	p	r	b	c	d	a	r	p	s	s	n	a
r	s	s	t	p	o	o	r	l	a	c	j	t	g	t
o	t	g	z	o	o	u	e	l	r	t	f	o	r	r
l	s	y	a	j	k	r	s	e	y	n	r	f	o	e
s	m	m	o	b	s	t	s	r	n	c	p	f	c	l
t	u	h	e	n	h	z	e	y	o	m	f	i	e	n
a	p	r	i	s	o	n	r	q	s	s	n	c	r	a
t	g	i	d	t	p	j	s	d	s	g	d	e	s	z
i	q	t	b	n	d	i	a	p	y	w	c	w	z	g
o	l	t	r	a	i	n	s	t	a	t	i	o	n	t
n	w	p	x	s	r	k	p	h	a	r	m	a	c	y

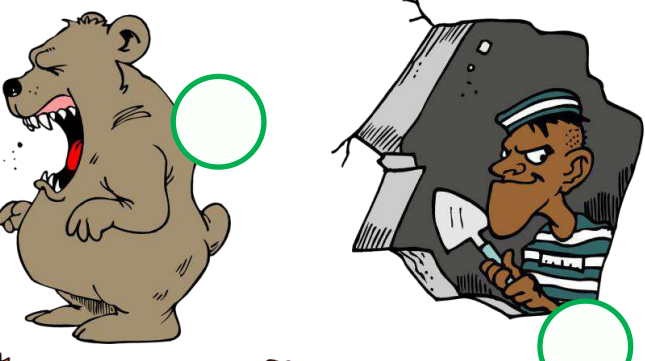
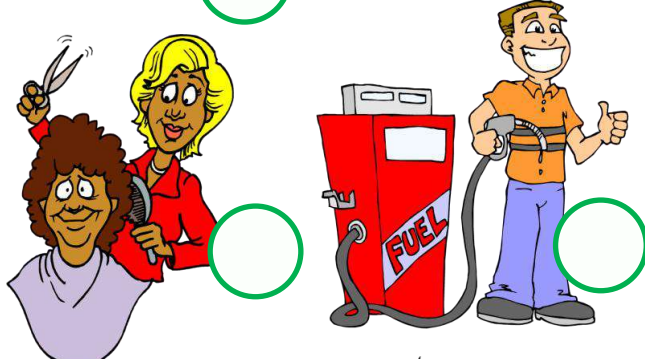

1. petrol station
2. bookshop
3. court
4. gallery
5. prison
6. greengrocer's
7. hairdresser's
8. cinema
9. florist's
10. library
11. train station
12. post office
13. zoo
14. pharmacy
15. gym
16. theatre

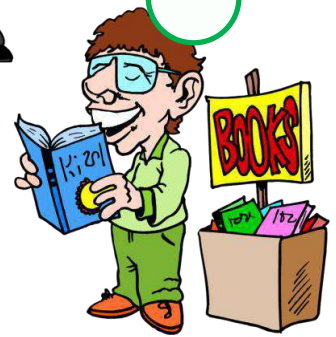

PLACES IN A CITY CROSSWORD PUZZLE !

Look at the numbers on the pictures and write the places in a city vocabulary in the crossword puzzle

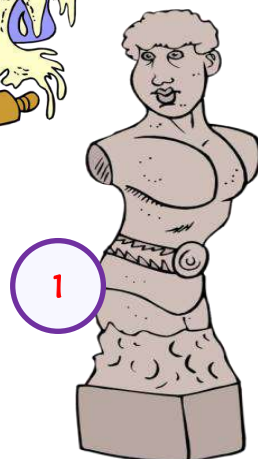
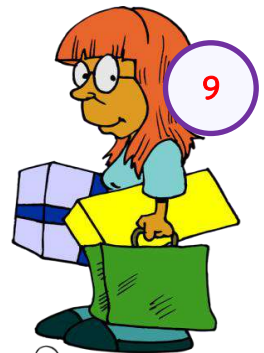
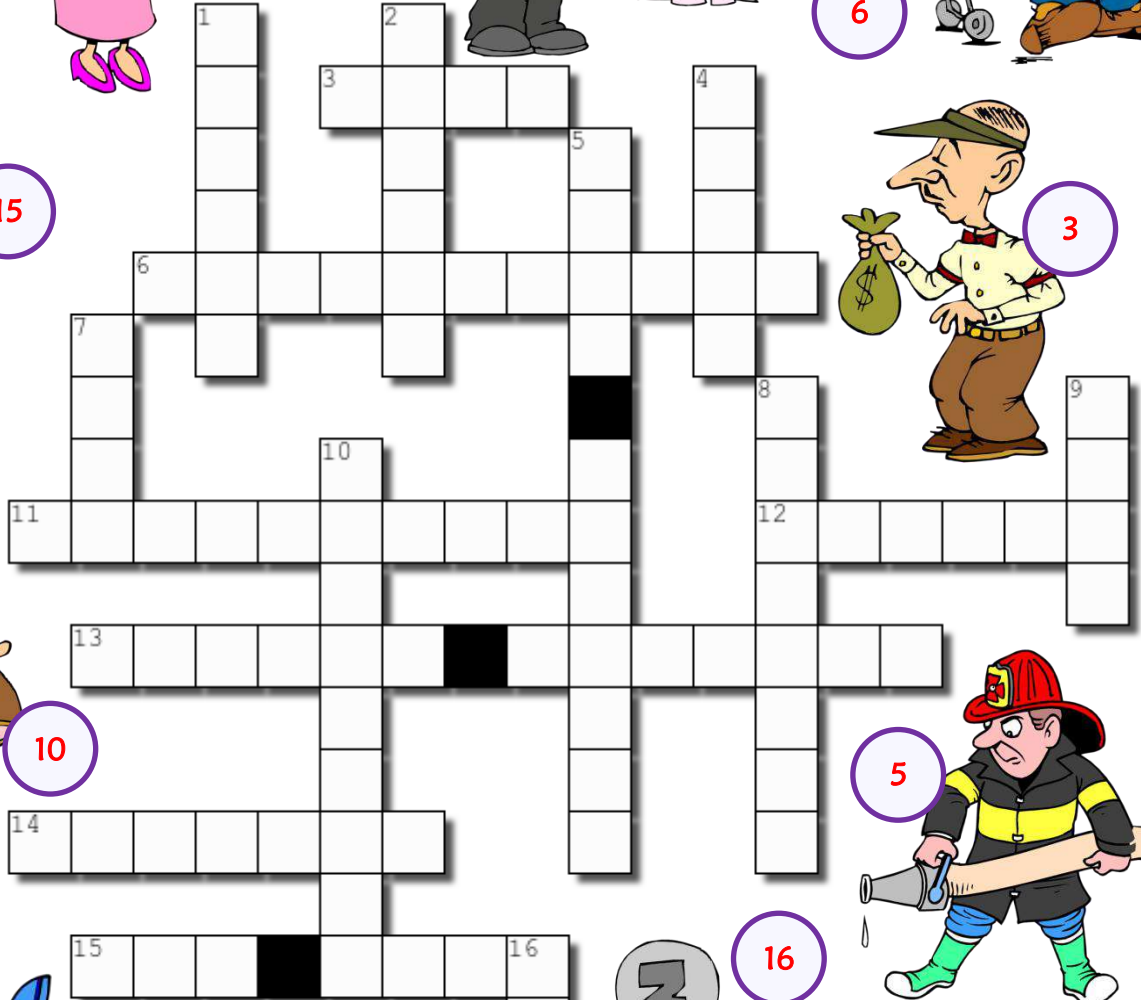

ANSWER KEY

Across

- 3. bank
- 6. supermarket
- 11. restaurant
- 12. school
- 13. police station
- 14. airport
- 15. bus stop

Down

- 1. museum
- 2. bakery
- 4. hotel
- 5. fire station
- 7. cafe
- 8. hospital
- 9. mall
- 10. butcher's
- 16. park

ANSWER KEY

Across

5. gallery

7. court

8. train station

9. post office

11. bookshop

12. library

13. hairdresser's

14. greengrocer's

16. cinema

Down

1. pharmacy

2. zoo

3. prison

4. petrol station

6. florist's

10. theatre

15. gym

PLACES IN A CITY MISSING LETTERS IN WORDS !

Write the missing letters in the boxes to complete the places in a city vocabulary



b_nk



__rport

m_s__m



h_sp_t_l



s_p_rm_rk_t

m_ll

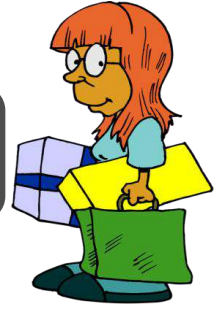

f_r_ st_t__n



h_t_l

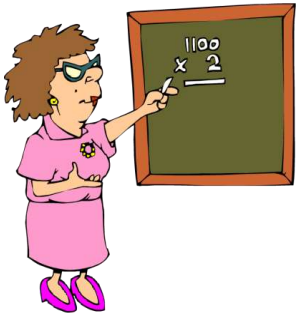

sch__l

b_s st_p



p_l_c_ st_t__n



c_f_



r_st__r_nt

b_tch_r's



b_k_ry



p_rk

PLACES IN A CITY MISSING LETTERS IN WORDS 2

Write the missing letters in the boxes to complete the places in a city vocabulary



p_tr_l st_t__n

z__



pr_s_n



g_ll_ry



c__rt

gr__ngr_c_r's



h__rdr_ss_r's



c_n_m_



fl_r_st's

l_br_ry

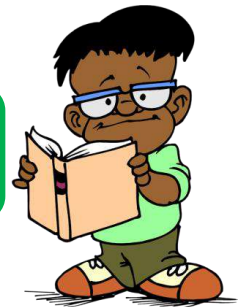

ph_rm_cy



p_st __ff_c_



g_m

tr__n st_t__n



b__ksh_p



th__tr_

PLACES IN A CITY MISSING LETTERS IN WORDS | ANSWER KEY

Write the missing letters in the boxes to complete the places in a city vocabulary



bank



airport

museum



hospital



supermarket

mall

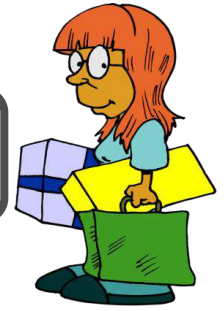

fire station



hotel

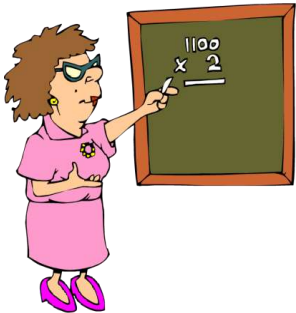

school

bus stop



police station



cafe



restaurant

butcher's



bakery



park

PLACES IN A CITY MISSING LETTERS IN WORDS 2 ANSWER KEY

Write the missing letters in the boxes to complete the places in a city vocabulary



petrol station

zoo



prison



gallery



court

greengrocer's



hairdresser's



cinema



florist's

library

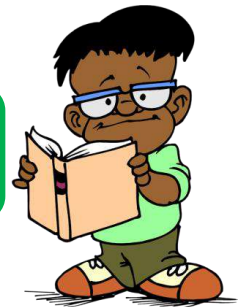

pharmacy



post office



gym

train station



bookshop



theatre



PLACES IN A CITY UNSCRAMBLE THE WORDS !

Unscramble the places in a city vocabulary and number the pictures

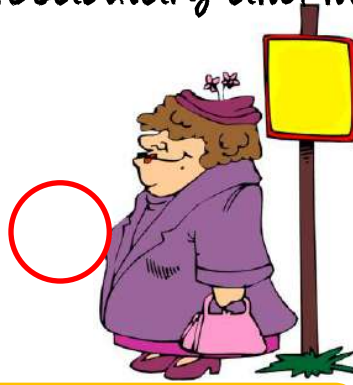
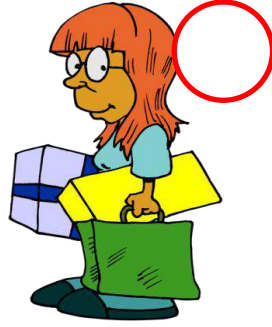
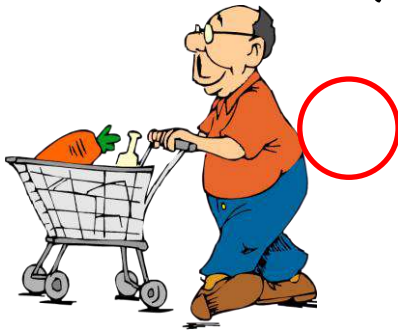

1. kbna _____

2. raprtio _____

3. summue _____

4. slatipho _____

5. rapkeemstru _____

6. lshoco _____

7. erfi otstnia _____

8. lehto _____

9. amll _____

10. cefa _____

11. usb ptso _____

12. oipelc aoitnst _____

13. uatnrterasa _____

14. ctuebrh's _____

15. eaybkr _____

16. aprk _____

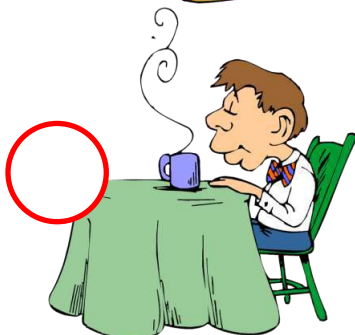
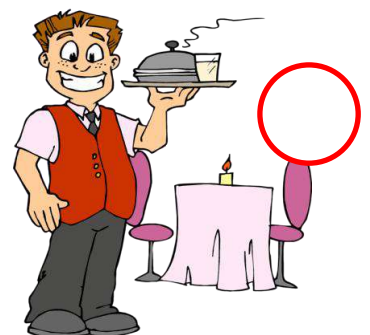
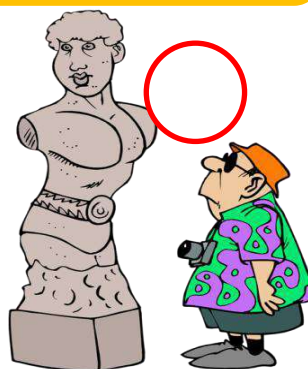
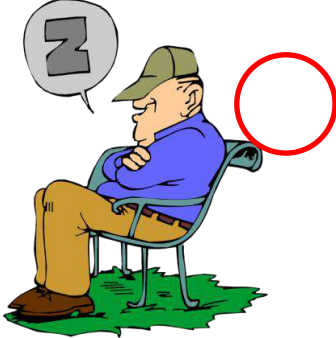
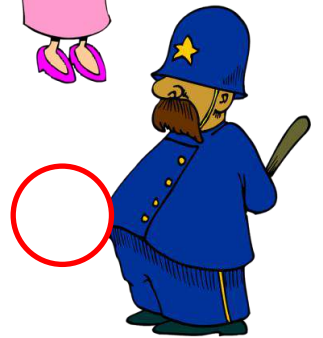
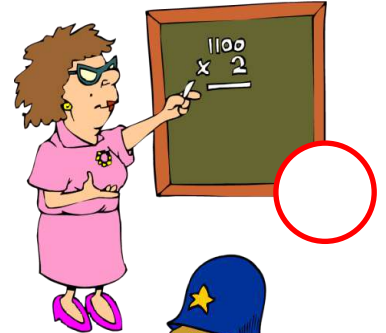
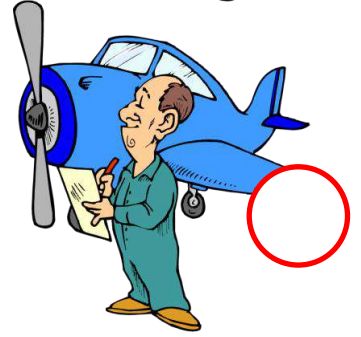

PLACES IN A CITY UNSCRAMBLE THE WORDS 2

Unscramble the places in a city vocabulary and number the pictures

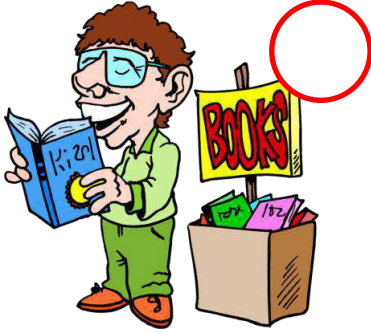
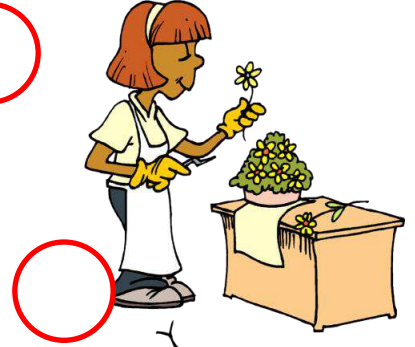
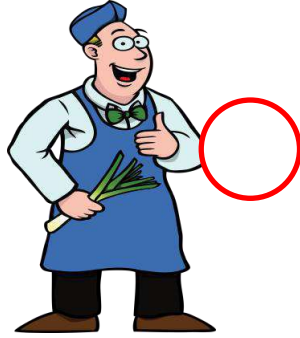
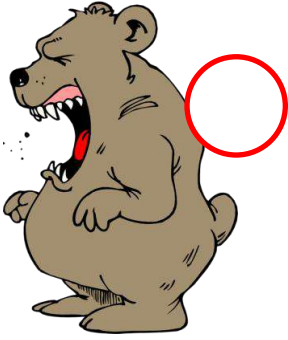

1. oerltp ttoiasn _____

2. hokosopb _____

3. orutc _____

4. eallyrg _____

5. nioprs _____

6. errgogreenc's _____

7. raedirsrhe's _____

8. nciema _____

9. forltsi's _____

10. lyrraib _____

11. aintr aonitts _____

12. ptso coffei _____

13. ozo _____

14. cahyrapm _____

15. ygm _____

16. thertea _____

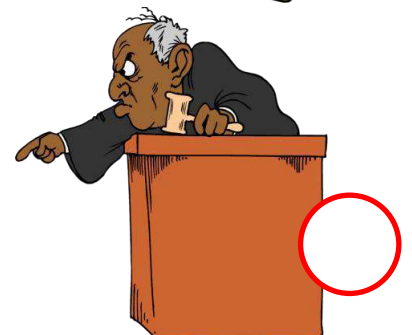
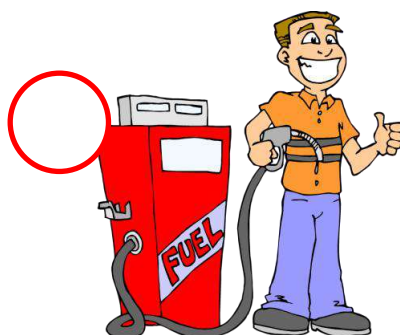
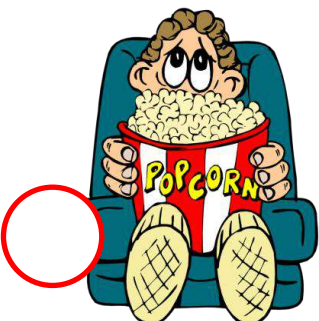
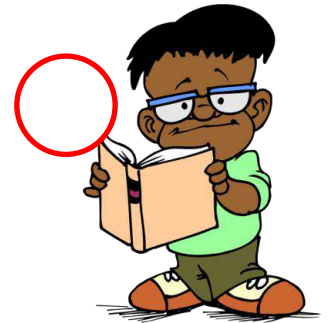
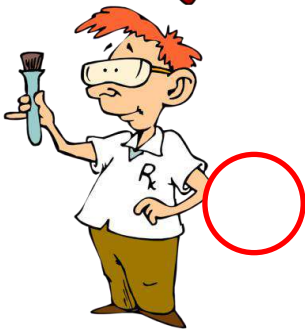
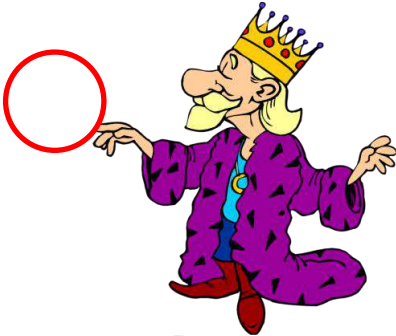

PLACES IN A CITY UNSCRAMBLE THE WORDS ! ANSWER KEY

Unscramble the places in a city vocabulary and number the pictures

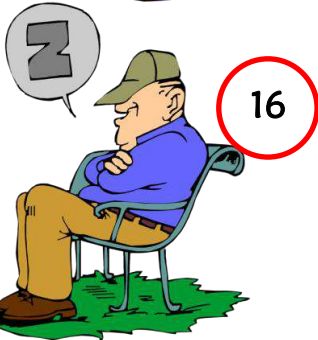
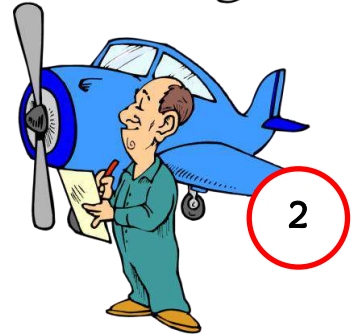
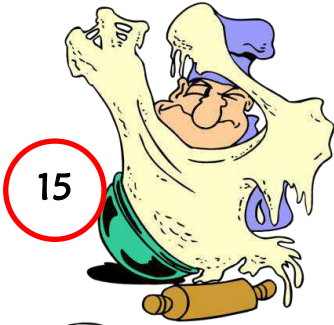
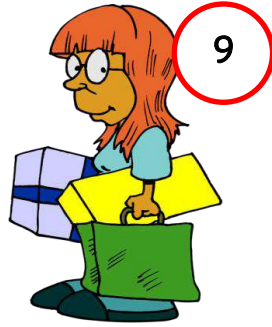
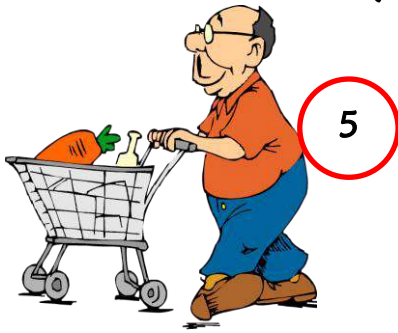

- | | |
|--------------------|----------------|
| 1. kbna | bank |
| 2. raprtio | airport |
| 3. summue | museum |
| 4. slatipho | hospital |
| 5. rapkeemstru | supermarket |
| 6. lshoco | school |
| 7. erfi otstnia | fire station |
| 8. lehto | hotel |
| 9. amll | mall |
| 10. cefa | cafe |
| 11. usb ptso | bus stop |
| 12. oipelc aoitnst | police station |
| 13. uatnrtsa | restaurant |
| 14. ctuebrh's | butcher's |
| 15. eaybkr | bakery |
| 16. aprk | park |

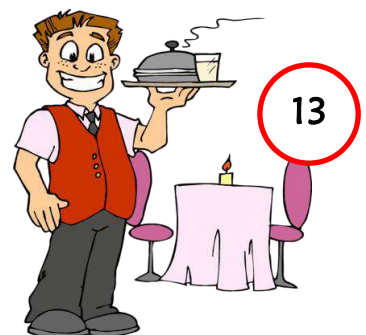
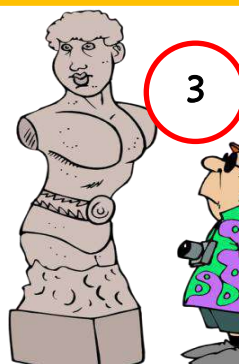
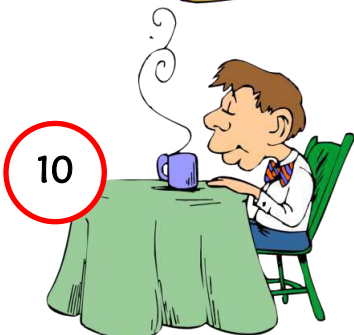
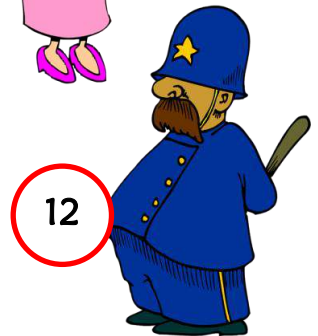
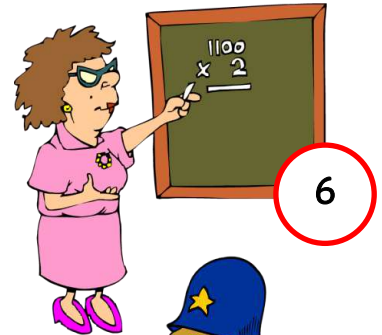

PLACES IN A CITY UNSCRAMBLE THE WORDS 2 ANSWER KEY

Unscramble the places in a city vocabulary and number the pictures

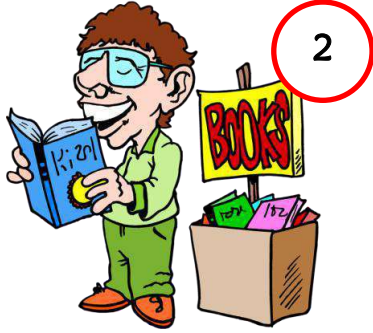
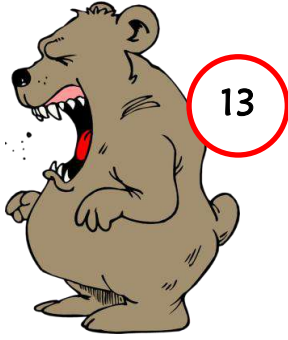

- | | |
|-------------------|----------------|
| 1. oerltp ttoiasn | petrol station |
| 2. hokosopb | bookshop |
| 3. orutc | court |
| 4. eallyrg | gallery |
| 5. nioprs | prison |
| 6. errgogreenc's | greengrocer's |
| 7. raedirsrhe's | hairdresser's |
| 8. nciema | cinema |
| 9. forltsi's | florist's |
| 10. lyrraib | library |
| 11. aintr aonitts | train station |
| 12. ptso coffei | post office |
| 13. ozo | zoo |
| 14. cahyrapm | pharmacy |
| 15. ygm | gym |
| 16. thertea | theatre |

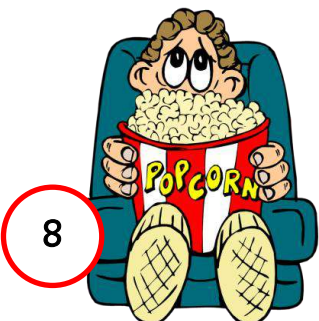
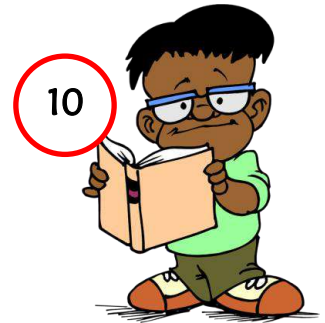

PLACES IN A CITY MULTIPLE CHOICE TEST !

Look at the pictures, choose and circle the correct option.



- a) school
- b) cafe
- c) bank
- d) park



- a) hotel
- b) airport
- c) police station
- d) restaurant



- a) mall
- b) supermarket
- c) butcher's
- d) museum

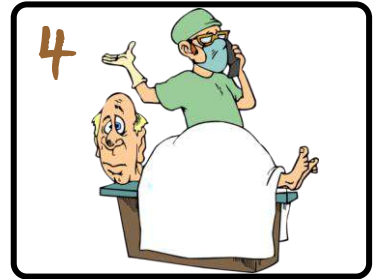

- a) bus stop
- b) hospital
- c) bakery
- d) fire station



- a) bus stop
- b) museum
- c) bakery
- d) supermarket

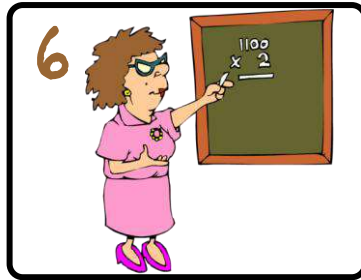

- a) mall
- b) restaurant
- c) school
- d) bank



- a) hospital
- b) fire station
- c) police station
- d) butcher's



- a) airport
- b) hotel
- c) park
- d) cafe

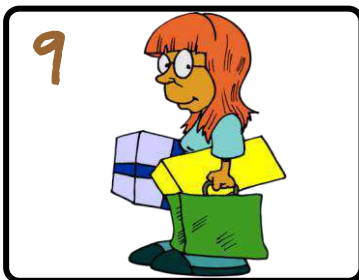

- a) fire station
- b) mall
- c) hospital
- d) butcher's



- a) exercise
- b) bakery
- c) cafe
- d) hotel



- a) park
- b) airport
- c) bus stop
- d) school



- a) police station
- b) supermarket
- c) restaurant
- d) museum

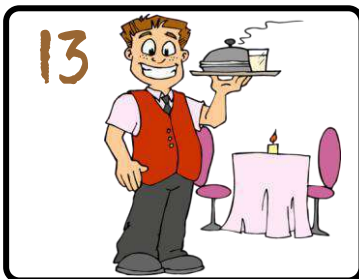

- a) airport
- b) restaurant
- c) fire station
- d) bus stop



- a) butcher's
- b) school
- c) bank
- d) police station

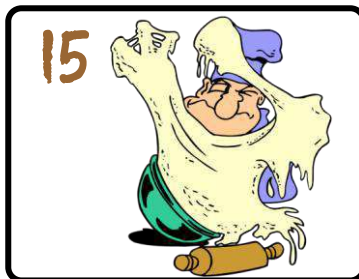

- a) bakery
- b) mall
- c) supermarket
- d) hospital

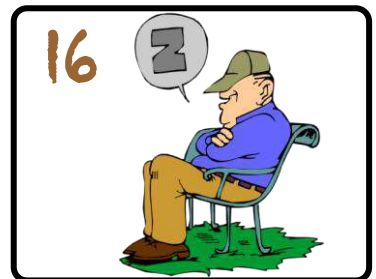

- a) hotel
- b) cafe
- c) museum
- d) park

PLACES IN A CITY MULTIPLE CHOICE TEST 2

Look at the pictures, choose and circle the correct option.



- a) hairdresser's
- b) petrol station
- c) pharmacy
- d) post office

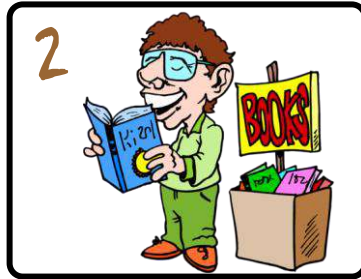

- a) train station
- b) cinema
- c) theatre
- d) bookshop



- a) prison
- b) zoo
- c) florist's
- d) court

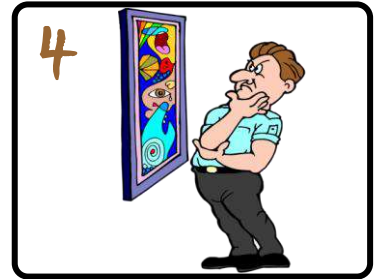

- a) gallery
- b) greengrocer's
- c) library
- d) gym



- a) train station
- b) prison
- c) court
- d) gym



- a) zoo
- b) florist's
- c) greengrocer's
- d) petrol station



- a) theatre
- b) hairdresser's
- c) bookshop
- d) library

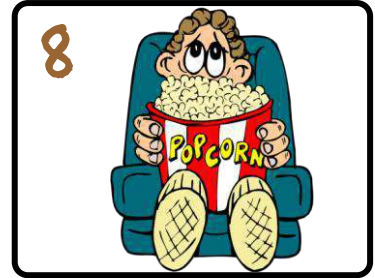

- a) post office
- b) pharmacy
- c) cinema
- d) gallery



- a) florist's
- b) gallery
- c) hairdresser's
- d) zoo

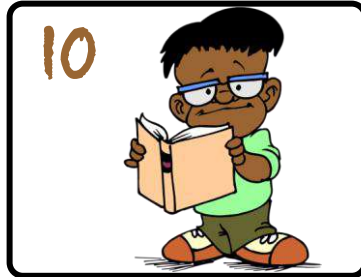

- a) gym
- b) court
- c) cinema
- d) library



- a) prison
- b) petrol station
- c) train station
- d) pharmacy



- a) greengrocer's
- b) post office
- c) theatre
- d) bookshop



- a) zoo
- b) bookshop
- c) train station
- d) cinema

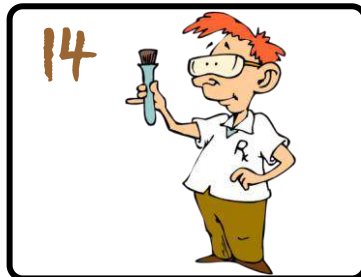

- a) post office
- b) prison
- c) pharmacy
- d) gallery



- a) library
- b) gym
- c) greengrocer's
- d) court



- a) hairdresser's
- b) theatre
- c) florist's
- d) petrol station

PLACES IN A CITY MULTIPLE CHOICE TESTS ANSWER KEY

TEST 1

- 1) c
- 2) b
- 3) d
- 4) b
- 5) d
- 6) c
- 7) b
- 8) b
- 9) b
- 10) c
- 11) c
- 12) a
- 13) b
- 14) a
- 15) a
- 16) d

TEST 2

- 1) b
- 2) d
- 3) d
- 4) a
- 5) b
- 6) c
- 7) b
- 8) c
- 9) a
- 10) d
- 11) c
- 12) b
- 13) a
- 14) c
- 15) b
- 16) b



bank



airport

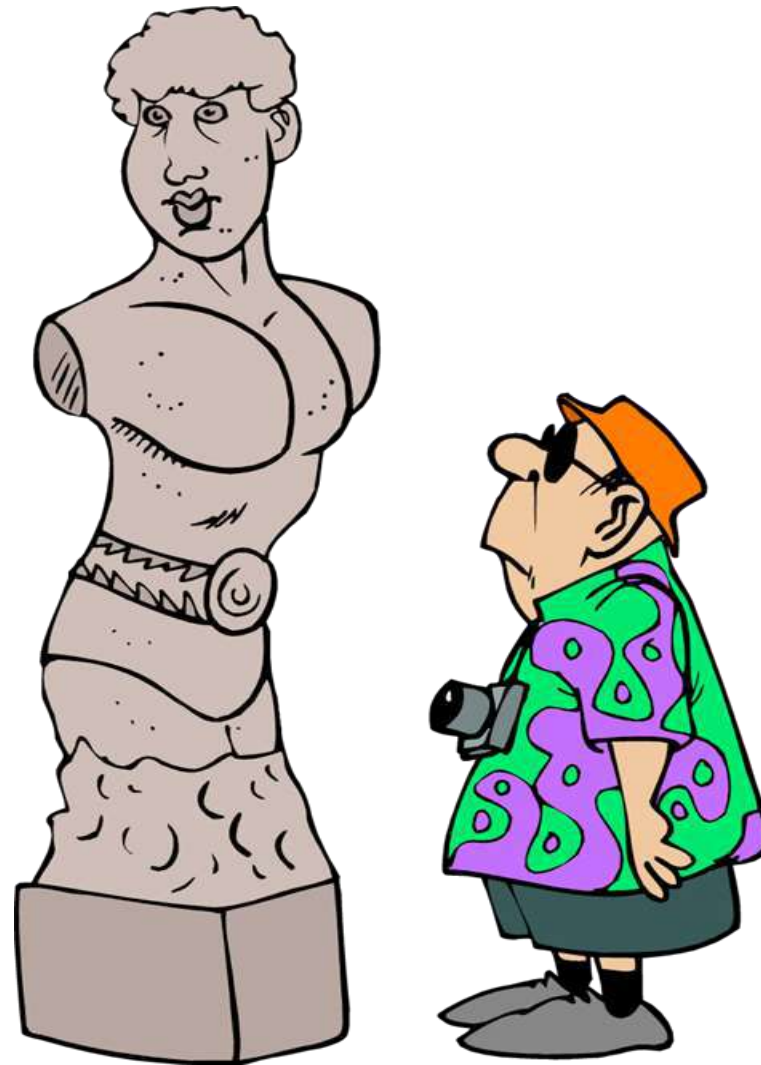

museum



hospital



supermarket

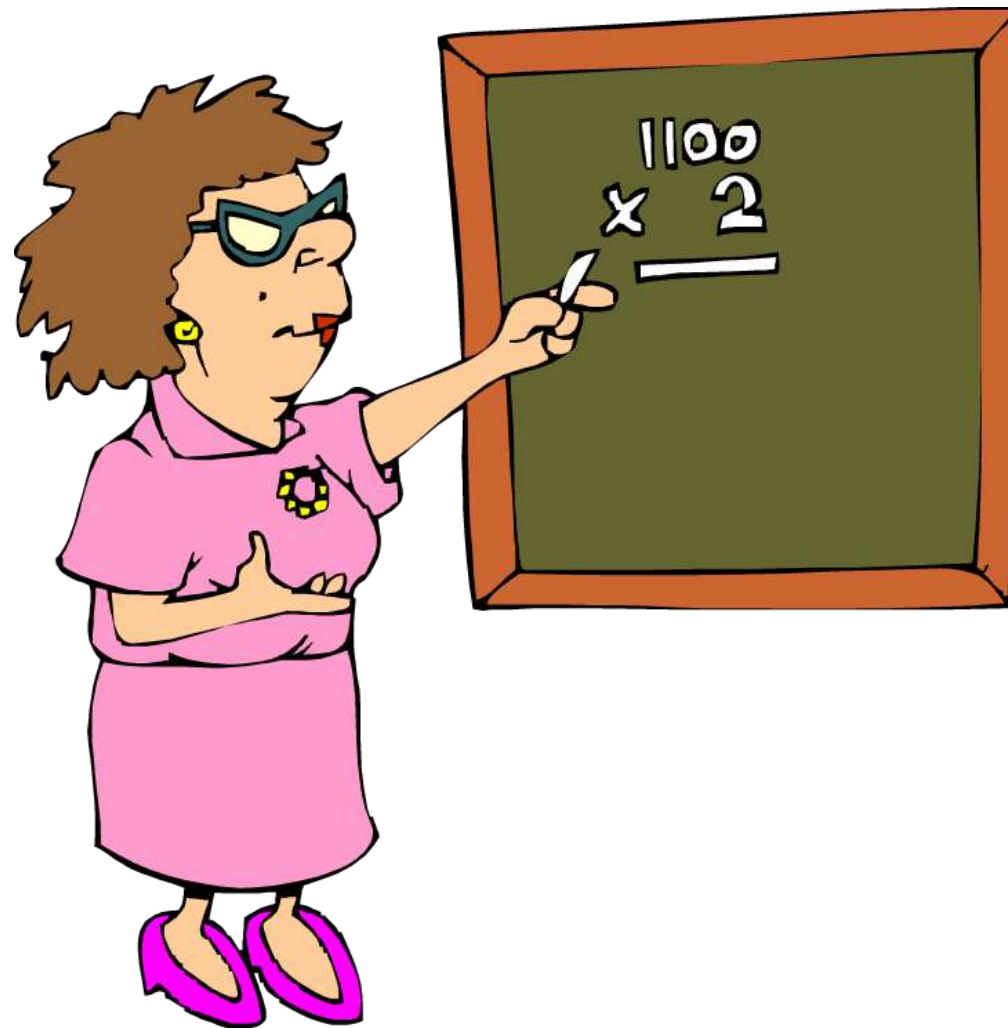

school



fire station



hotel

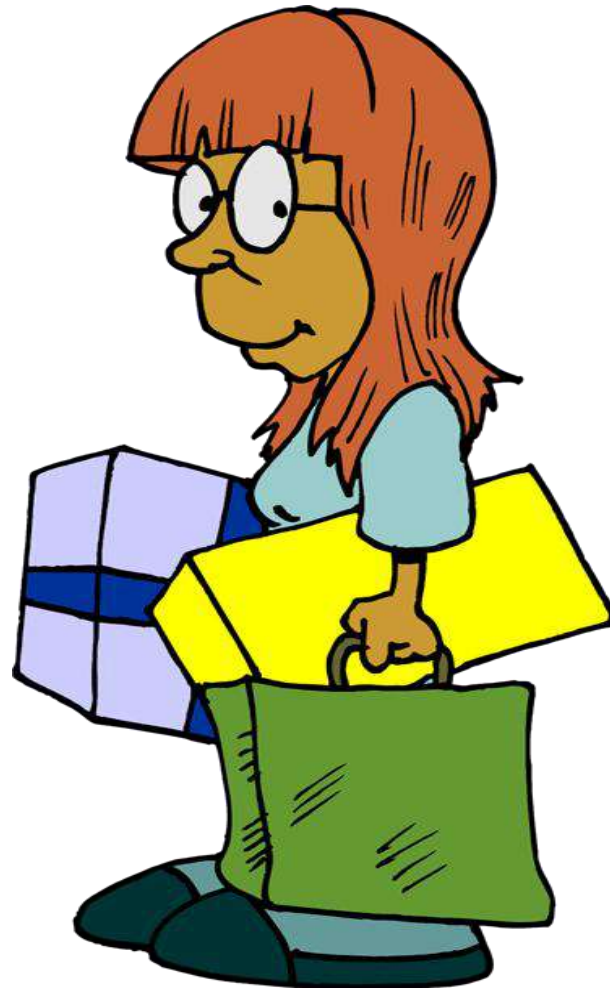

mall



cafe



bus stop



police station



restaurant



butcher's



bakery



park

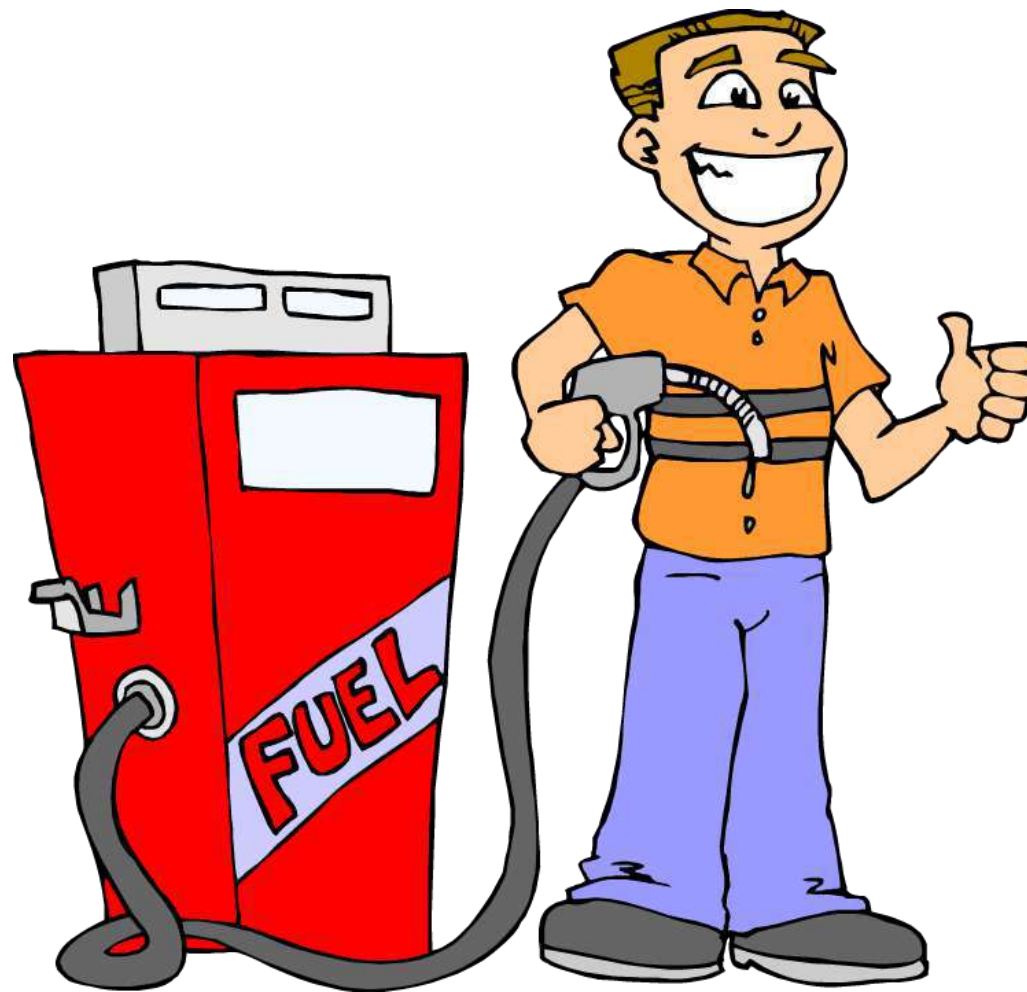

petrol station

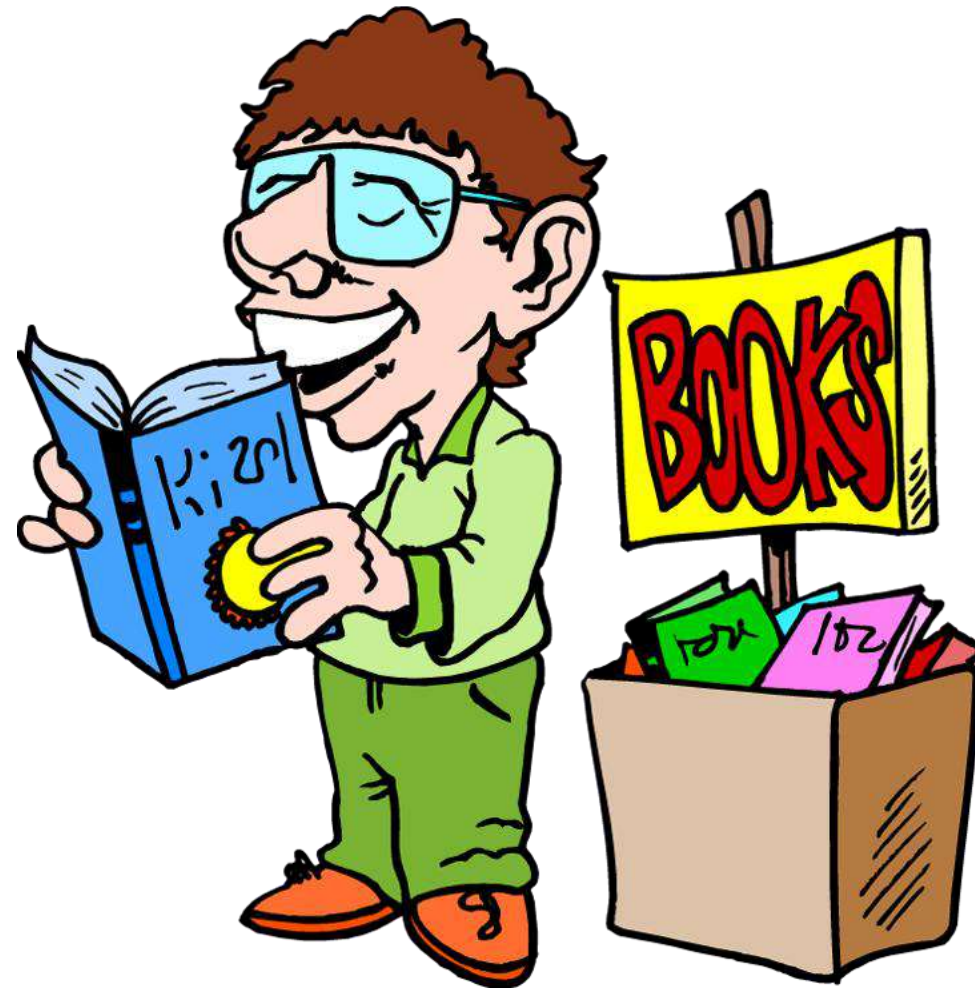

bookshop



court



gallery



prison



greengrocer's



hairdresser's



cinema



florist's

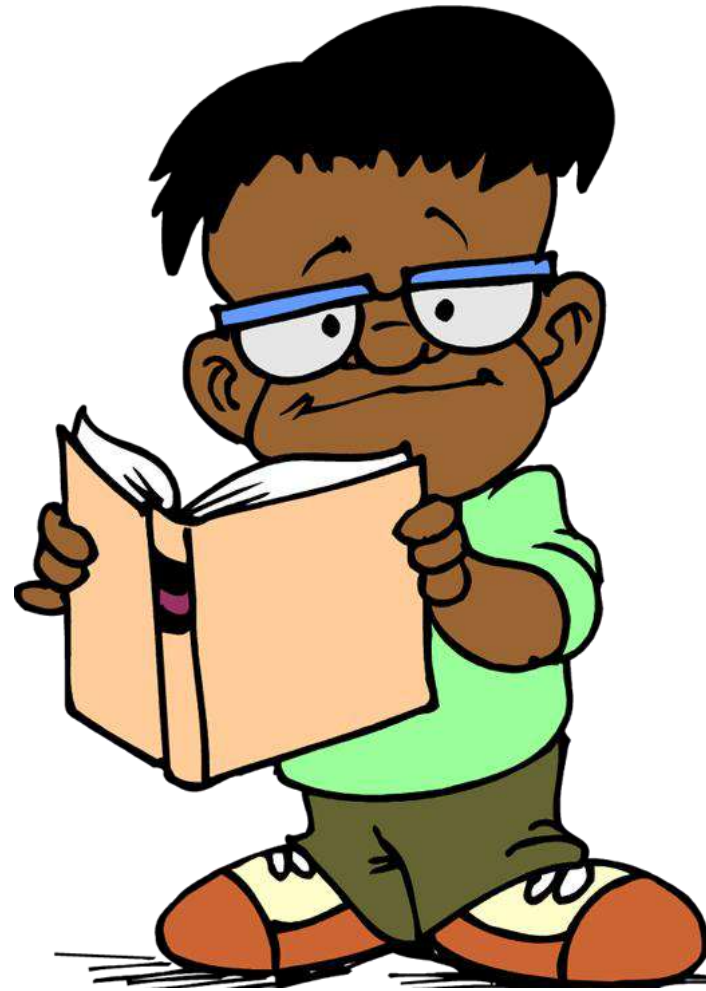

library



train station



post office



ZOO

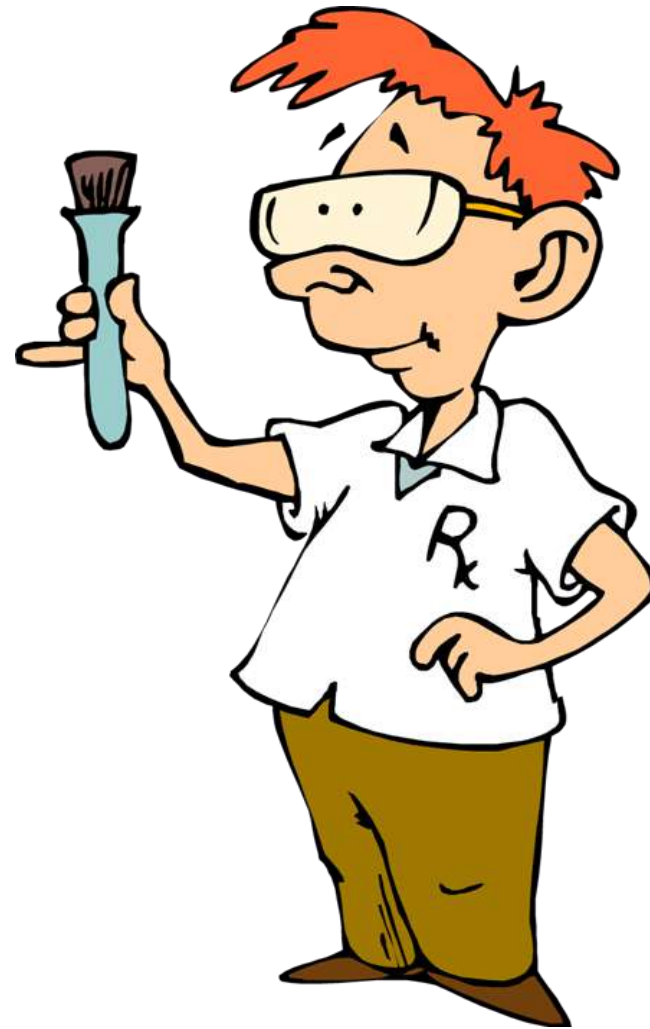

pharmacy



gym



theatre





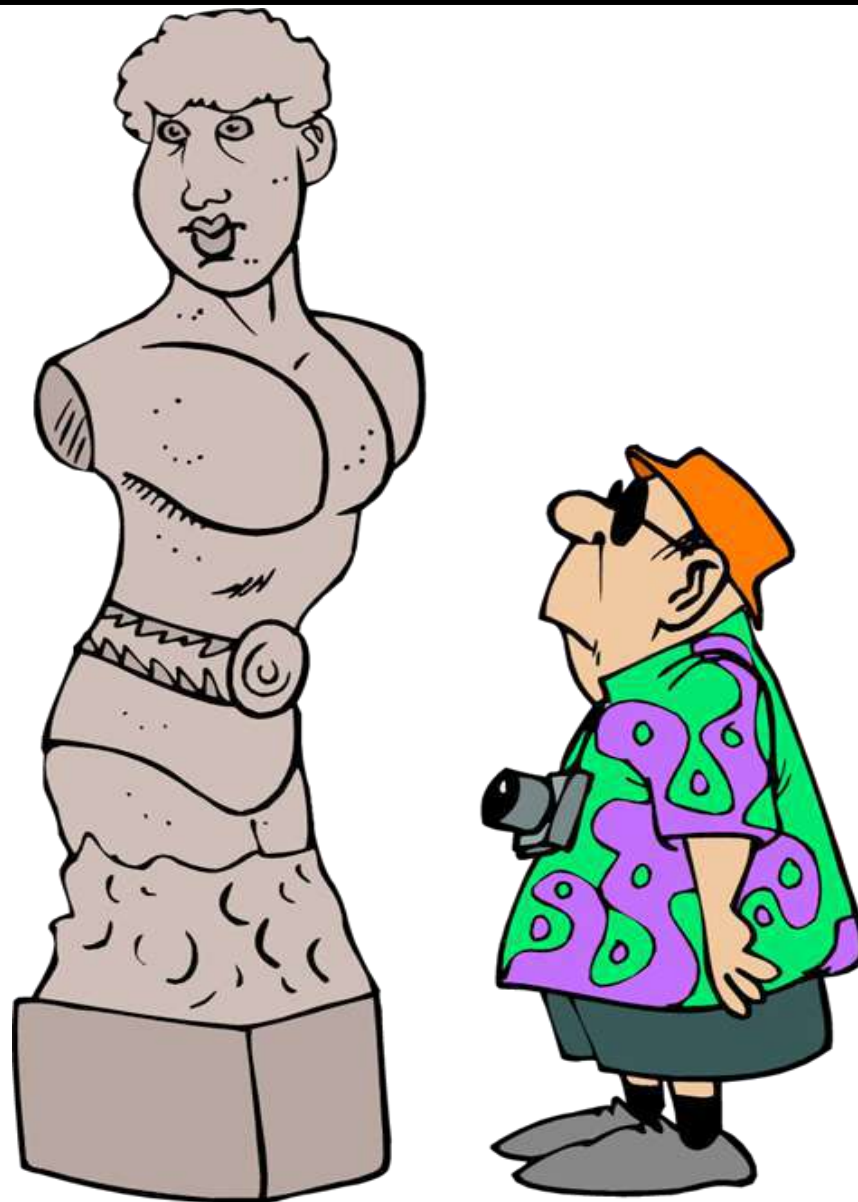





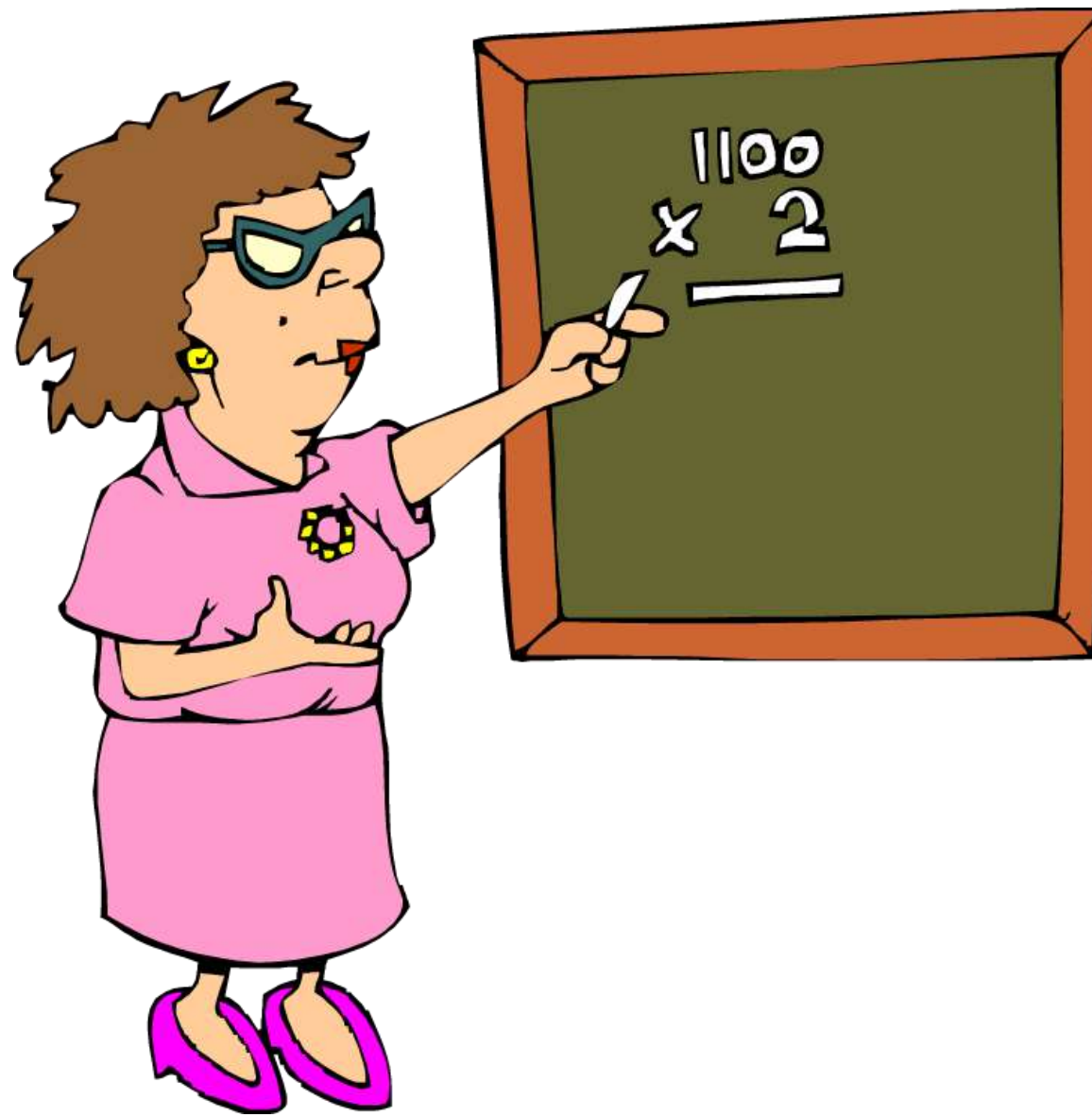





















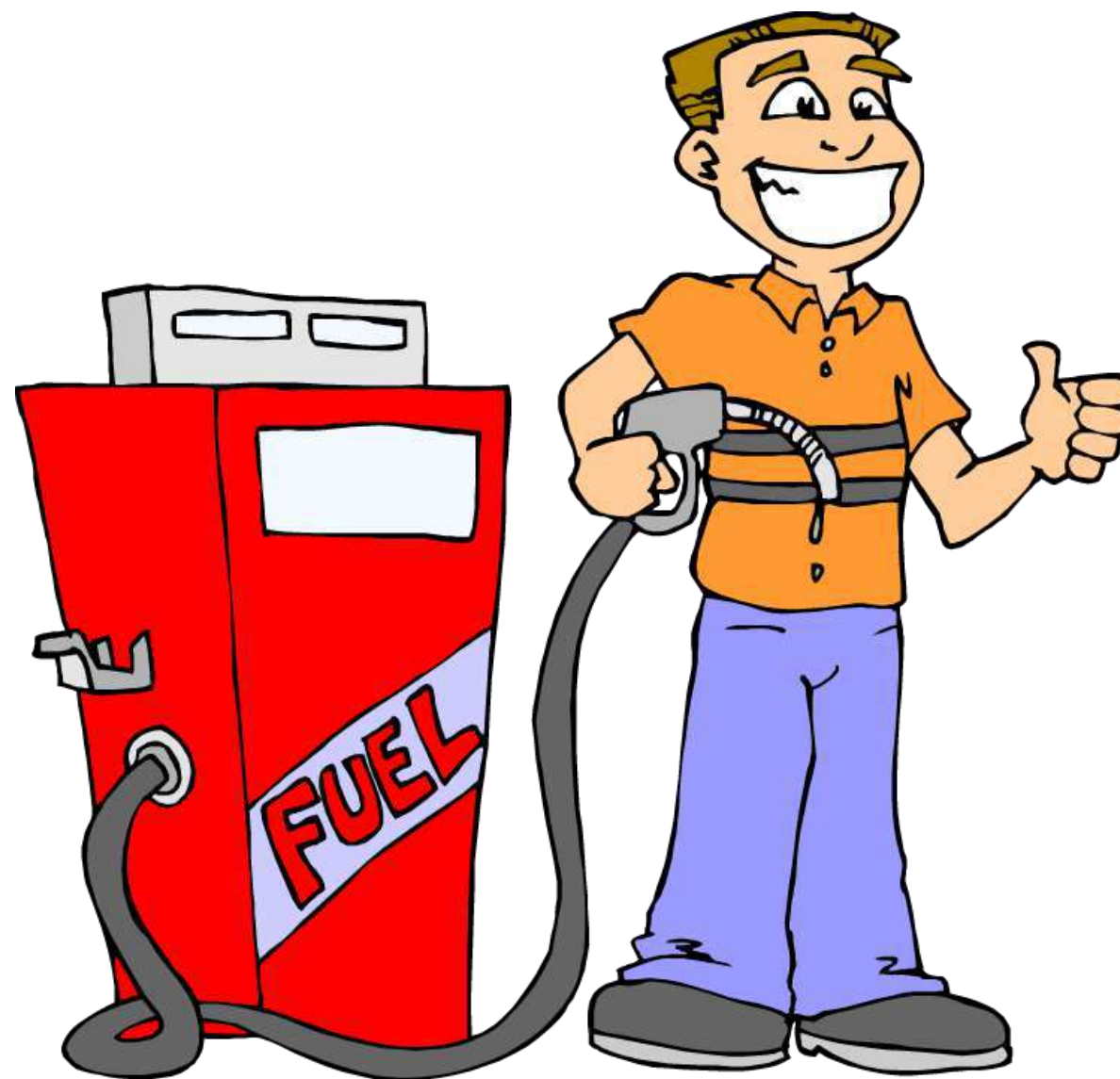

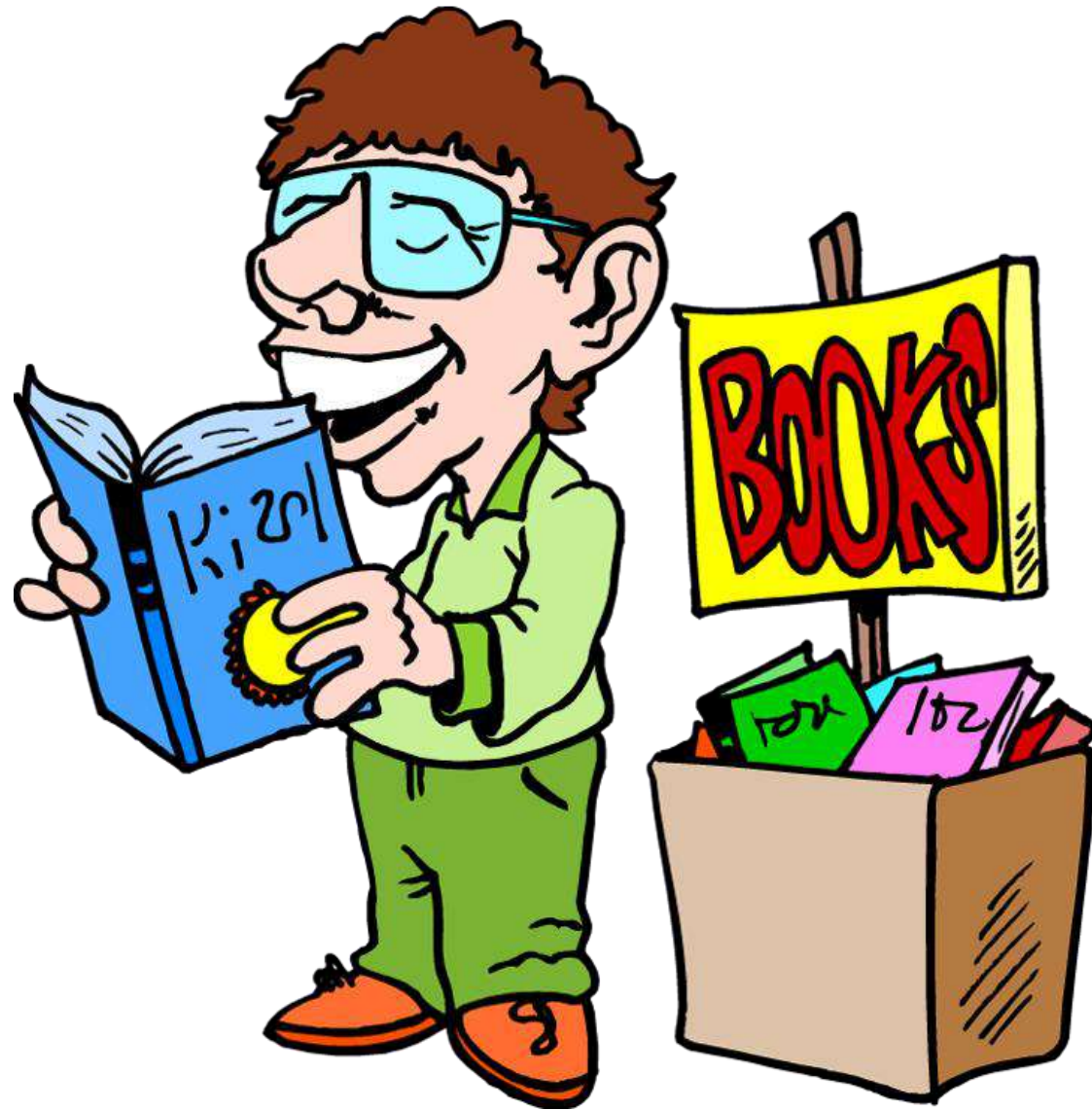











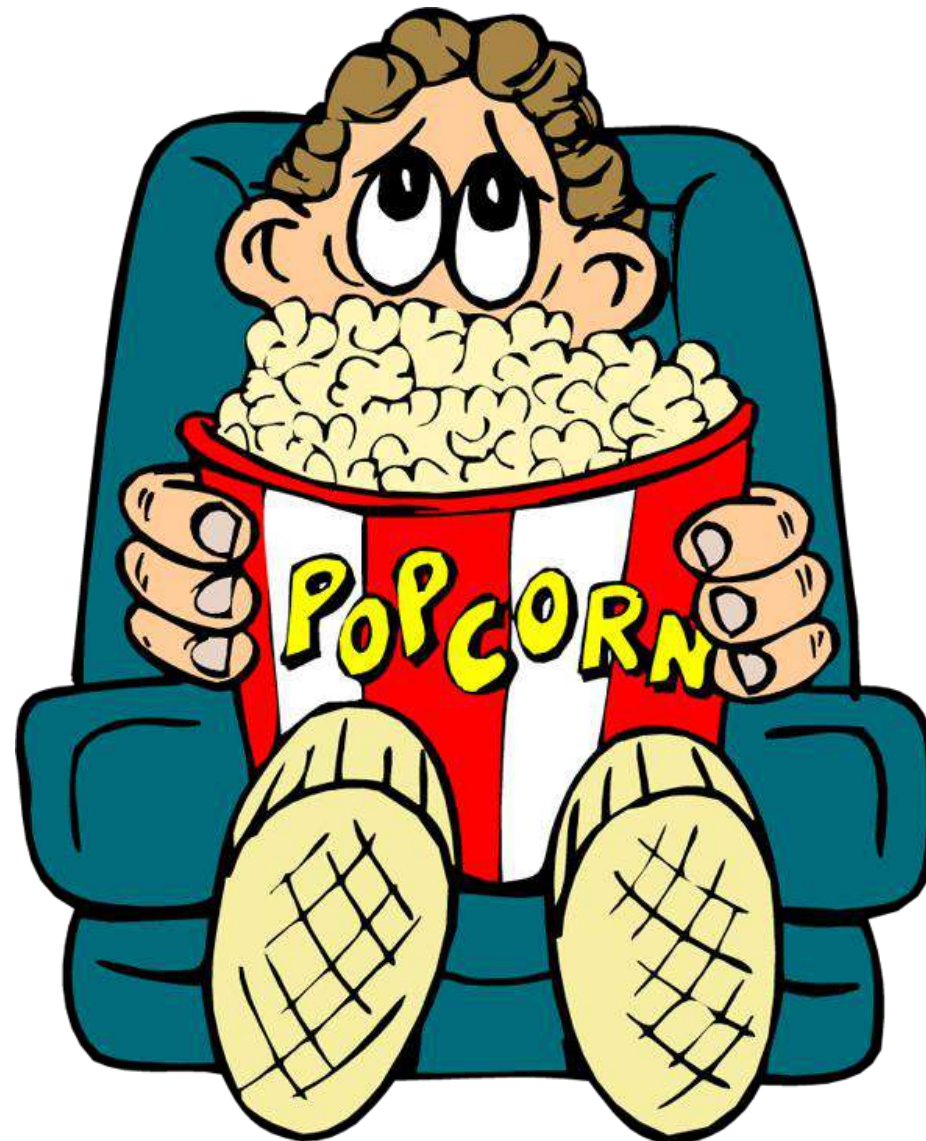



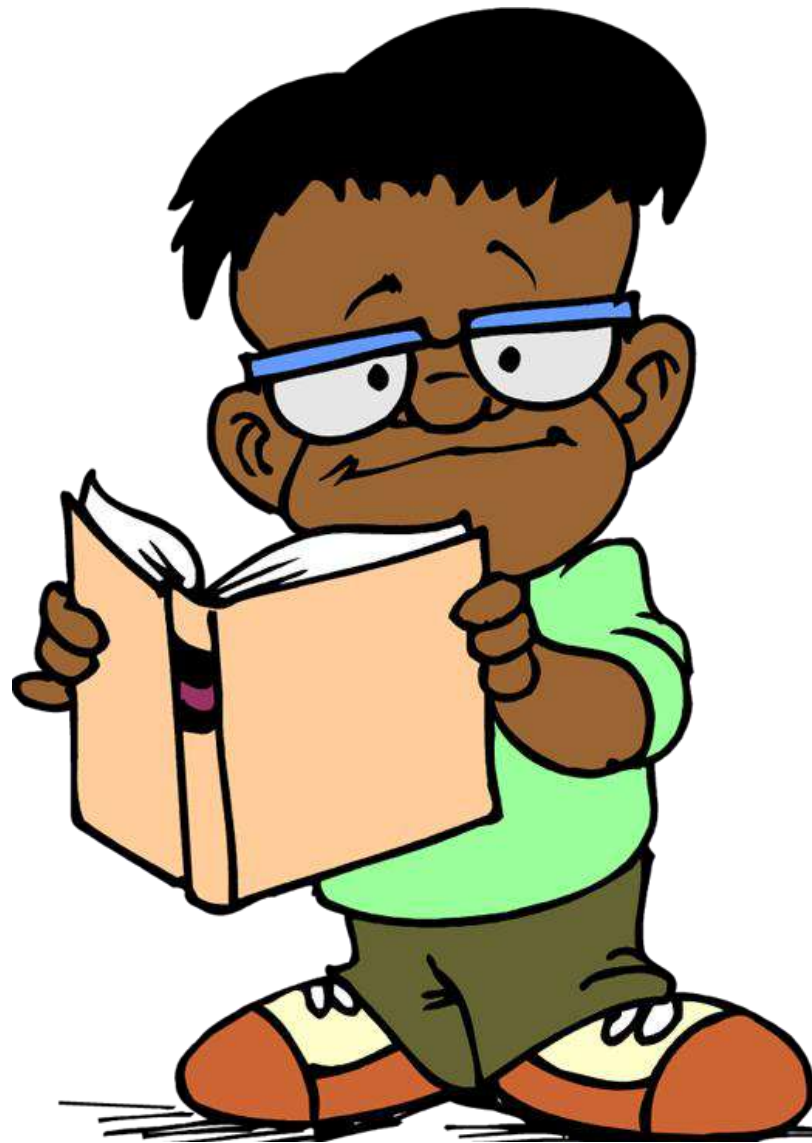







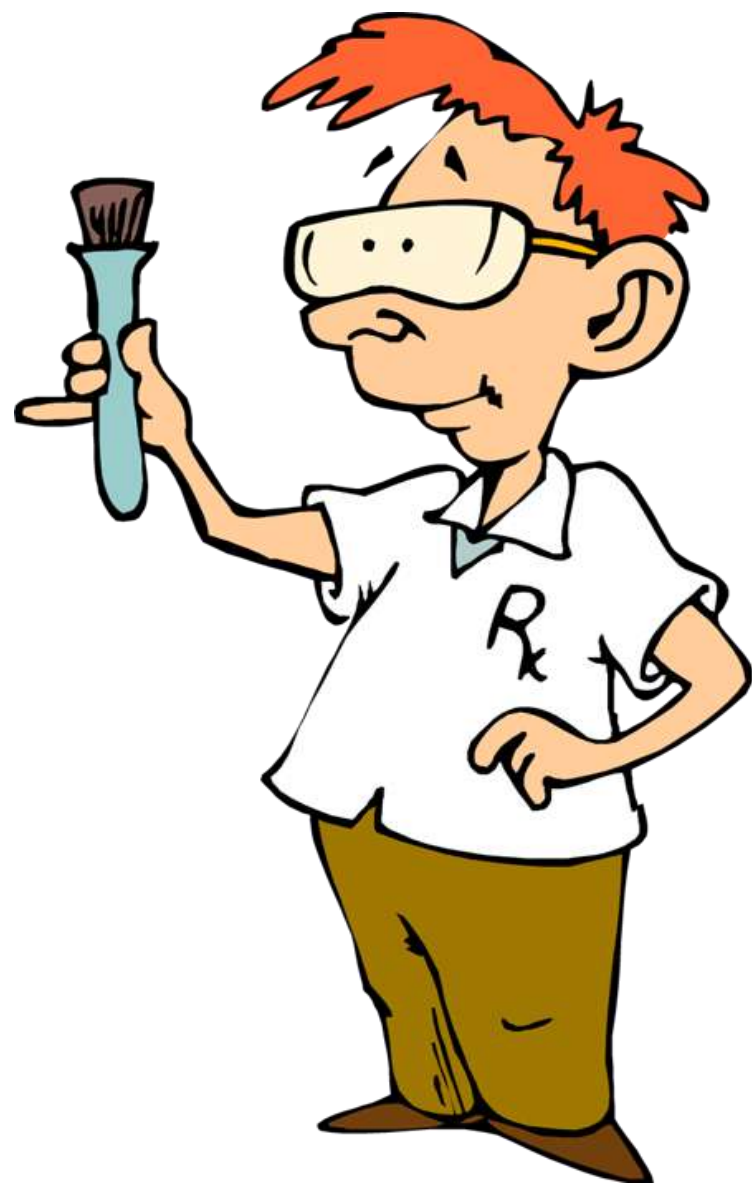







bank

Copyright © 13/10/2019 englishsheets.com. All rights reserved.

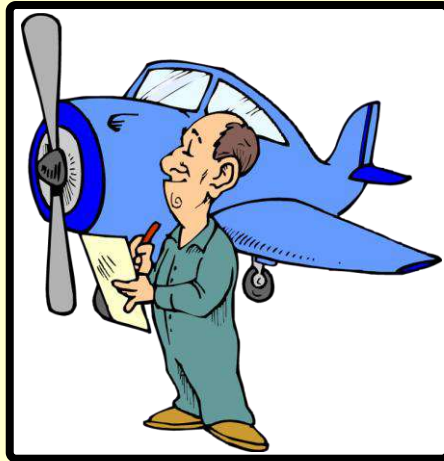

airport

Copyright © 13/10/2019 englishsheets.com. All rights reserved.

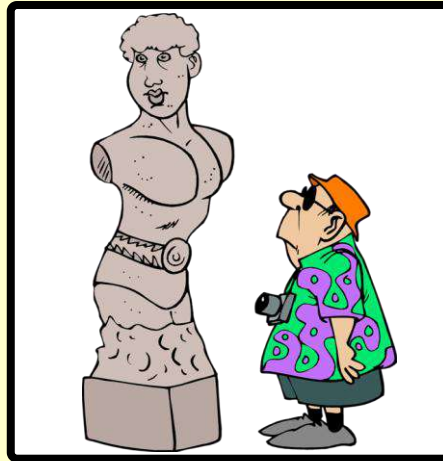

museum

Copyright © 13/10/2019 englishsheets.com. All rights reserved.

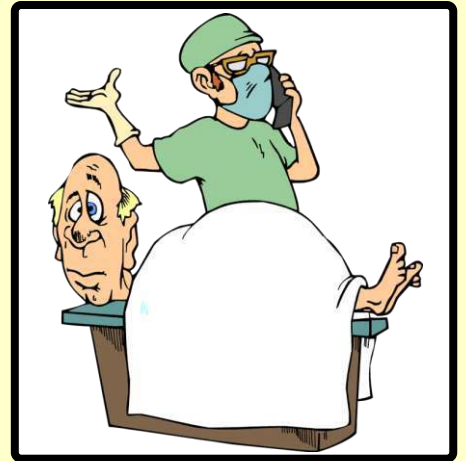

hospital

Copyright © 13/10/2019 englishsheets.com. All rights reserved.



supermarket

Copyright © 13/10/2019 englishsheets.com. All rights reserved.

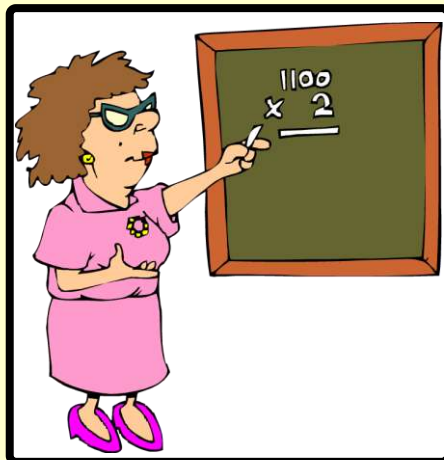

school

Copyright © 13/10/2019 englishsheets.com. All rights reserved.



fire station

Copyright © 13/10/2019 englishsheets.com. All rights reserved.



hotel

Copyright © 13/10/2019 englishsheets.com. All rights reserved.



mall

Copyright © 13/10/2019 englishsheets.com. All rights reserved.



cafe

Copyright © 13/10/2019 englishsheets.com. All rights reserved.



bus stop

Copyright © 13/10/2019 englishsheets.com. All rights reserved.



police station

Copyright © 13/10/2019 englishsheets.com. All rights reserved.



restaurant

Copyright © 13/10/2019 englishsheets.com. All rights reserved.



butcher's

Copyright © 13/10/2019 englishsheets.com. All rights reserved.

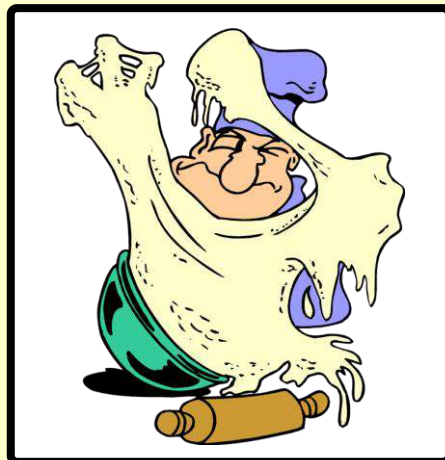

bakery

Copyright © 13/10/2019 englishsheets.com. All rights reserved.



park

Copyright © 13/10/2019 englishsheets.com. All rights reserved.

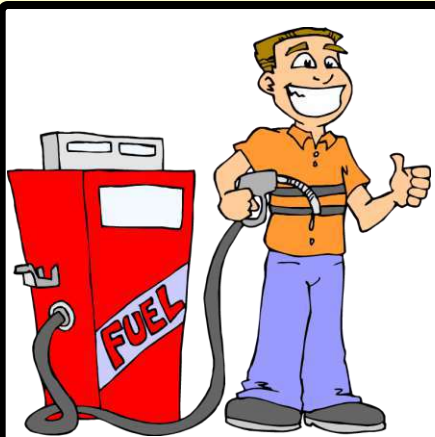

petrol station

Copyright © 13/10/2019 englishsheets.com. All rights reserved.

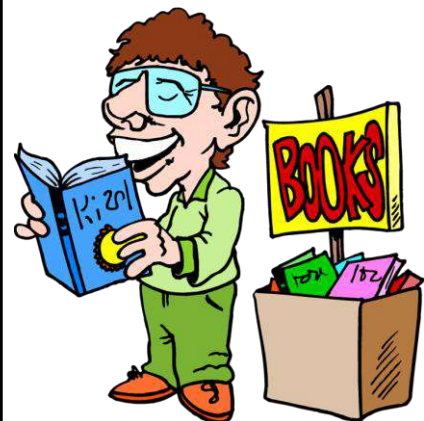

bookshop

Copyright © 13/10/2019 englishsheets.com. All rights reserved.



court

Copyright © 13/10/2019 englishsheets.com. All rights reserved.



gallery

Copyright © 13/10/2019 englishsheets.com. All rights reserved.



prison

Copyright © 13/10/2019 englishsheets.com. All rights reserved.



greengrocer's

Copyright © 13/10/2019 englishsheets.com. All rights reserved.



hairdresser's

Copyright © 13/10/2019 englishsheets.com. All rights reserved.

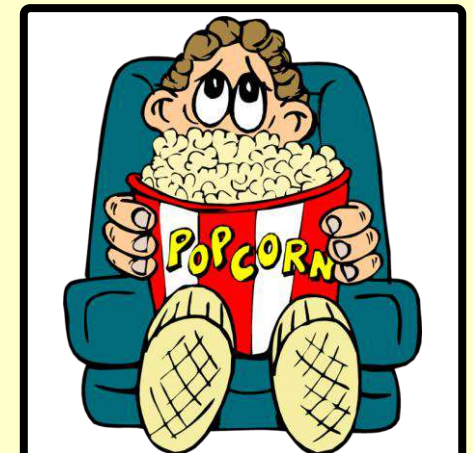

cinema

Copyright © 13/10/2019 englishsheets.com. All rights reserved.



florist's

Copyright © 13/10/2019 englishsheets.com. All rights reserved.

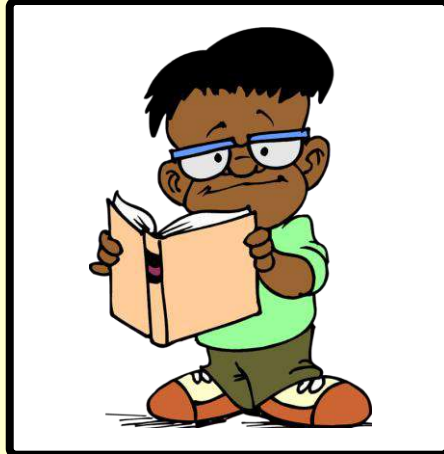

library

Copyright © 13/10/2019 englishsheets.com. All rights reserved.



train station

Copyright © 13/10/2019 englishsheets.com. All rights reserved.



post office

Copyright © 13/10/2019 englishsheets.com. All rights reserved.



zoo

Copyright © 13/10/2019 englishsheets.com. All rights reserved.

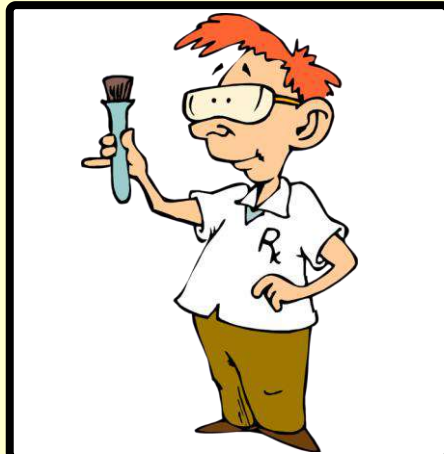

pharmacy

Copyright © 13/10/2019 englishsheets.com. All rights reserved.



gym

Copyright © 13/10/2019 englishsheets.com. All rights reserved.



theatre

Copyright © 13/10/2019 englishsheets.com. All rights reserved.

PLACES IN A CITY FIDGET SPINNER GAME



- Cut a small arrow from paper or craft foam and stick it onto the fidget spinner as your pointer.
- Place the fidget spinner in the middle of the vocabulary circle.
- Spin it and say the word quickly!

PLACES IN A CITY FIDGET SPINNER GAME

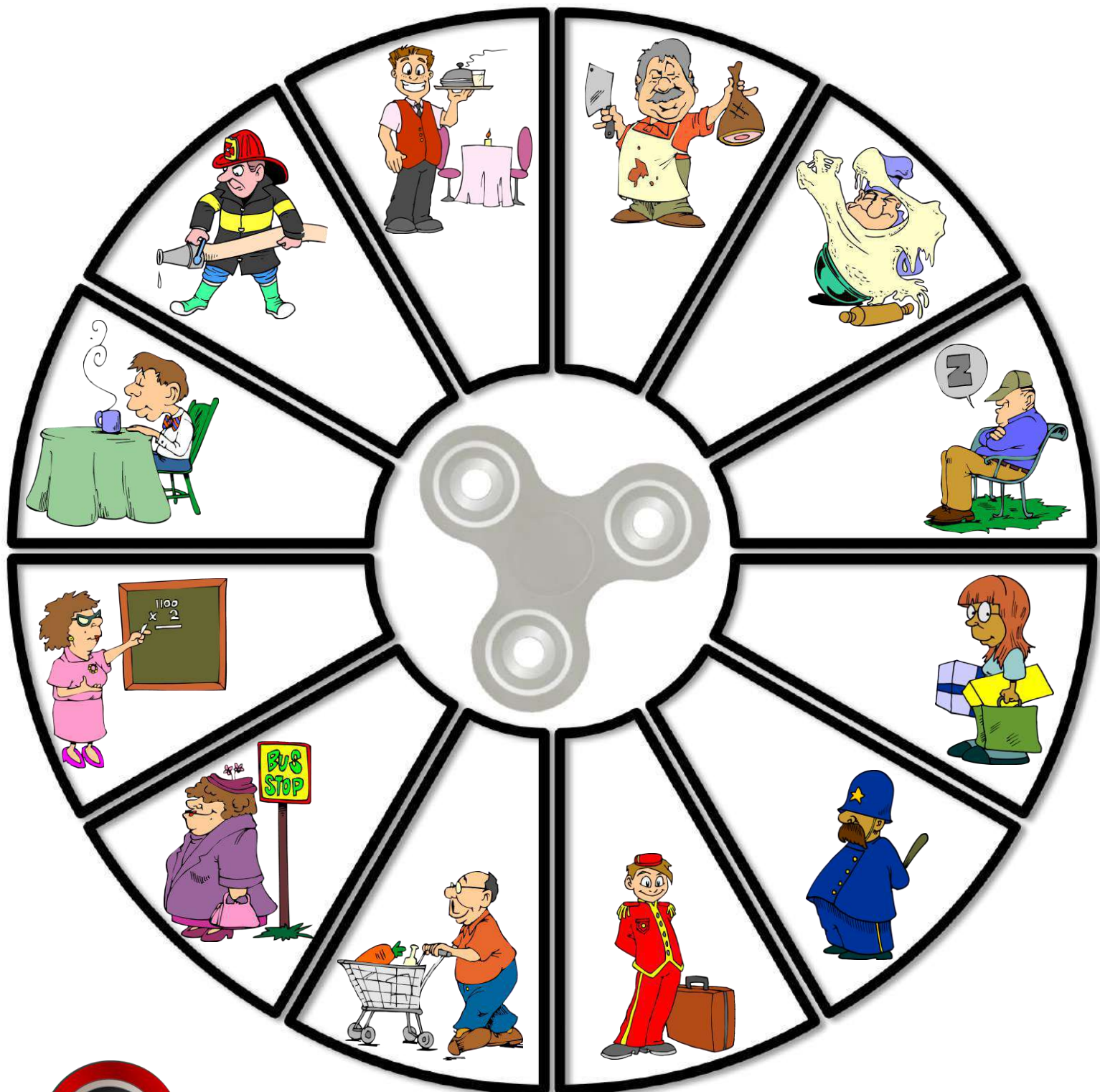

- Cut a small arrow from paper or craft foam and stick it onto the fidget spinner as your pointer.
- Place the fidget spinner in the middle of the vocabulary circle.
- Spin it and say the word quickly!

PLACES IN A CITY FIDGET SPINNER GAME



- Cut a small arrow from paper or craft foam and stick it onto the fidget spinner as your pointer.
- Place the fidget spinner in the middle of the vocabulary circle.
- Spin it and say the word quickly!

PLACES IN A CITY FIDGET SPINNER GAME



- Cut a small arrow from paper or craft foam and stick it onto the fidget spinner as your pointer.
- Place the fidget spinner in the middle of the vocabulary circle.
- Spin it and say the word quickly!



bank



airport



museum



hospital



supermarket



school



fire station



hotel



mall



cafe



bus stop

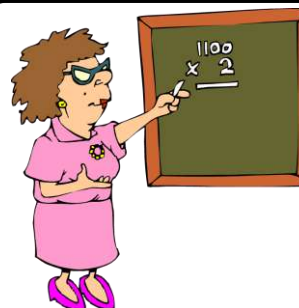

police station



restaurant



butcher's



bakery



park



petrol station



bookshop



court



gallery

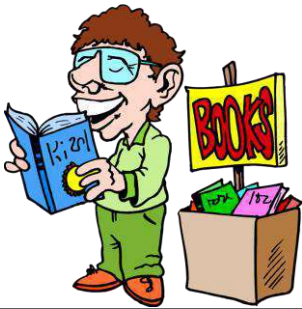

prison



greengrocer's



hairdresser's



cinema



florist's



library

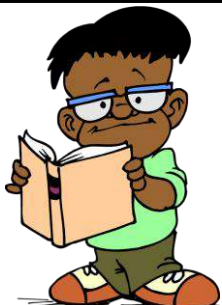

train station



post office



zoo



pharmacy



gym



theatre

PLACES IN A HOUSE PICTURE DICTIONARY



living room



kitchen



bedroom

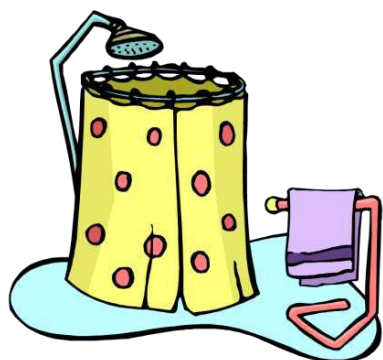

bathroom

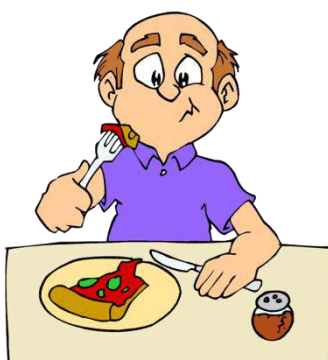

dining room



study



laundry



toilet



garden



garage



swimming pool



attic

PLACES IN A HOUSE PICTURE DICTIONARY



living room



kitchen



bedroom

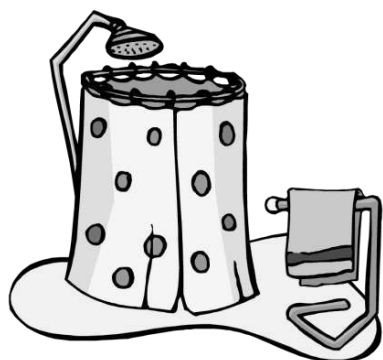

bathroom

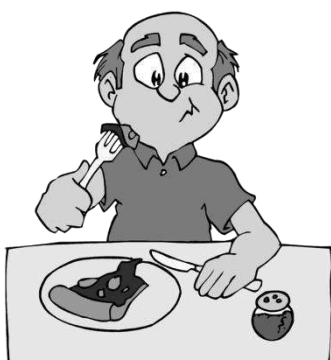

dining room



study



laundry



toilet



garden



garage

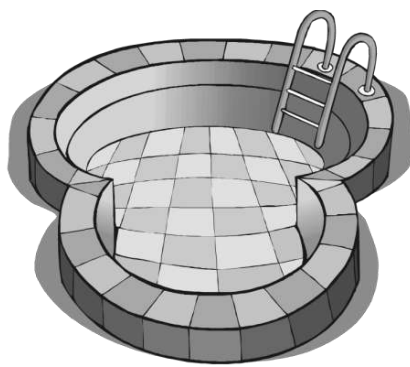

swimming pool



attic

PLACES IN A HOUSE VOCABULARY MATCHING WORKSHEET

Choose the correct words from the list below and write them under the correct pictures

- living room
- kitchen
- bedroom
- bathroom

- dining room
- study
- laundry
- toilet

- garden
- garage
- swimming pool
- attic







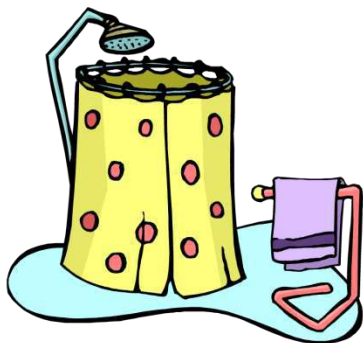









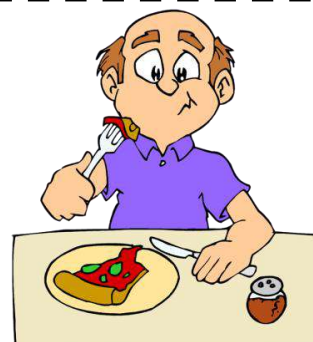







PLACES IN A HOUSE VOCABULARY MATCHING WORKSHEET ANSWER KEY

Choose the correct words from the list below and write them under the correct pictures

- living room
- kitchen
- bedroom
- bathroom

- dining room
- study
- laundry
- toilet

- garden
- garage
- swimming pool
- attic



garden



study

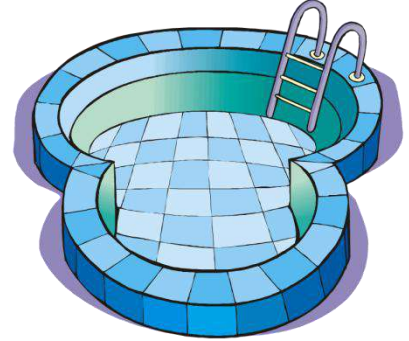

swimming pool

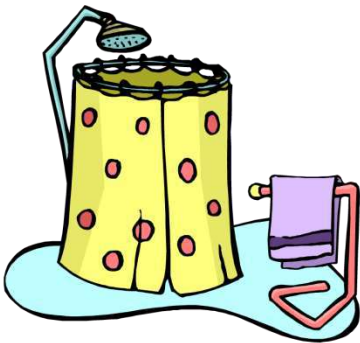

bathroom



toilet



bedroom



kitchen



attic

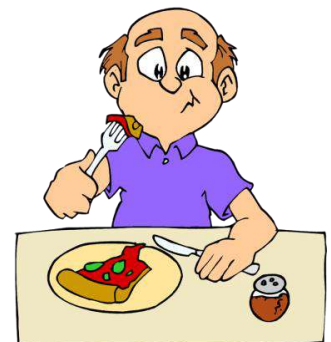

dining room



garage

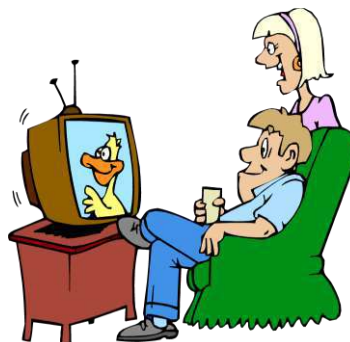

living room



laundry

PLACES IN A HOUSE VOCABULARY WORD SEARCH PUZZLE

Find and circle the words in the word search puzzle and number the pictures

p	d	o	b	e	d	r	o	o	m	v	h	v	b	c	c	d	k	l	a
x	o	z	o	m	t	e	a	a	c	g	u	k	a	p	i	i	q	s	r
s	w	i	m	m	i	n	g	p	o	o	l	r	t	c	v	n	m	t	b
j	k	i	t	c	h	e	n	n	l	f	g	z	h	u	o	i	q	u	s
d	f	q	j	l	f	g	s	i	a	a	a	q	r	v	s	n	h	d	b
v	y	r	s	i	r	l	i	p	u	x	r	x	o	m	g	g	n	y	k
m	v	f	y	v	v	s	k	w	n	r	d	j	o	a	v	r	g	b	j
p	z	n	u	i	k	u	f	l	d	c	e	o	m	g	u	o	z	d	x
g	a	a	k	n	b	f	j	n	r	l	n	v	g	a	w	o	y	n	j
t	n	b	m	g	y	k	s	e	y	h	t	f	j	r	m	m	w	y	i
o	x	m	d	r	a	t	t	i	c	u	b	d	p	a	u	b	i	a	l
i	i	i	q	o	j	u	f	z	o	t	i	f	m	g	b	q	o	w	r
l	p	s	e	o	j	b	e	f	m	i	h	c	j	e	t	i	e	v	t
e	v	g	r	m	f	g	x	f	k	b	s	m	k	y	y	s	r	o	u
t	b	b	j	v	s	z	b	u	e	r	n	m	j	s	u	r	v	s	o

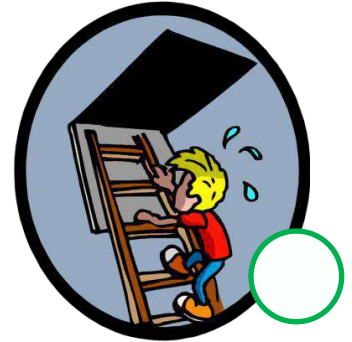
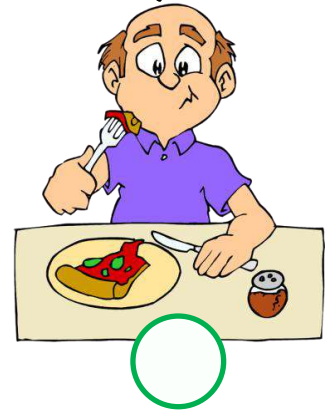

1. living room
2. kitchen
3. bedroom
4. bathroom
5. dining room
6. study
7. laundry
8. toilet
9. garden
10. garage
11. swimming pool
12. attic

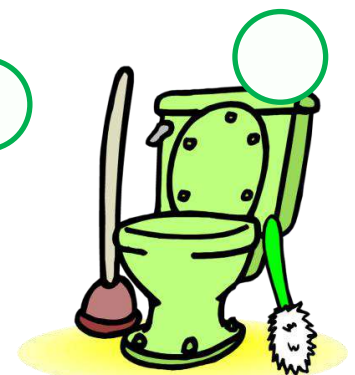
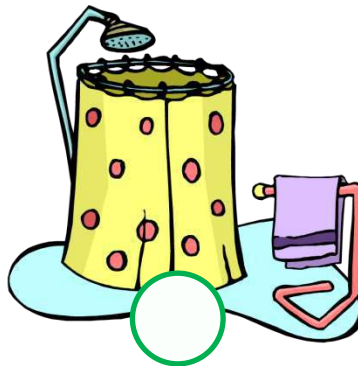
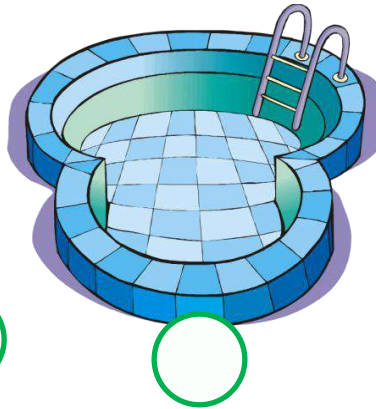

PLACES IN A HOUSE VOCABULARY WORD SEARCH PUZZLE ANSWER KEY

Find and circle the words in the word search puzzle and number the pictures

p	d	o	b	e	d	r	o	o	m	v	h	v	b	c	c	d	k	l	a
x	o	z	o	m	t	e	a	a	c	g	u	k	a	p	i	i	q	s	r
s	w	i	m	m	i	n	g	p	o	o	l	r	t	c	v	n	m	t	b
j	k	i	t	c	h	e	n	n	l	f	g	z	h	u	o	i	q	u	s
d	f	q	j	l	f	g	s	i	a	a	a	q	r	v	s	n	h	d	b
v	y	r	s	i	r	l	i	p	u	x	r	x	o	m	g	g	n	y	k
m	v	f	y	v	v	s	k	w	n	r	d	j	o	a	v	r	g	b	j
p	z	n	u	i	k	u	f	l	d	c	e	o	m	g	u	o	z	d	x
g	a	a	k	n	b	f	j	n	r	l	n	v	g	a	w	o	y	n	j
t	n	b	m	g	y	k	s	e	y	h	t	f	j	r	m	m	w	y	i
o	x	m	d	r	a	t	t	i	c	u	b	d	p	a	u	b	i	a	l
i	i	i	q	o	j	u	f	z	o	t	i	f	m	g	b	q	o	w	r
l	p	s	e	o	j	b	e	f	m	i	h	c	j	e	t	i	e	v	t
e	v	g	r	m	f	g	x	f	k	b	s	m	k	y	y	s	r	o	u
t	b	b	j	v	s	z	b	u	e	r	n	m	j	s	u	r	v	s	o

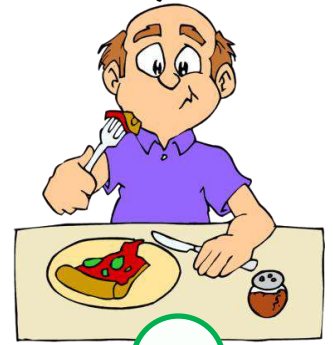

5



12

1. living room
2. kitchen
3. bedroom
4. bathroom
5. dining room
6. study
7. laundry
8. toilet
9. garden
10. garage
11. swimming pool
12. attic

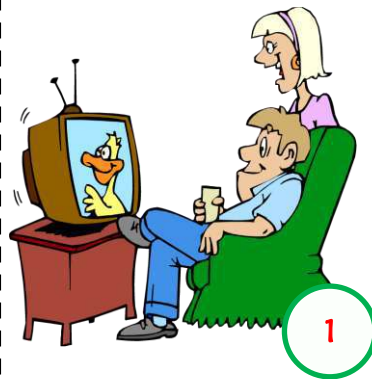

1

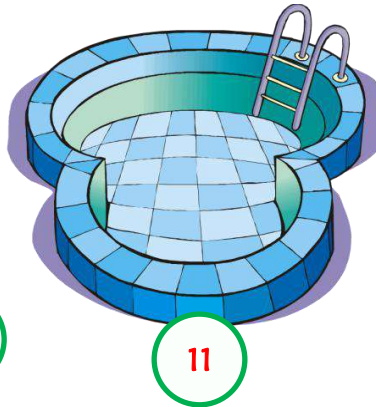

11



9



2



3



6



10

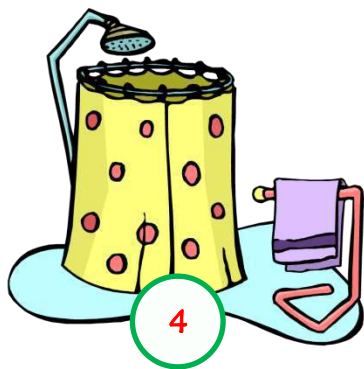

4



7

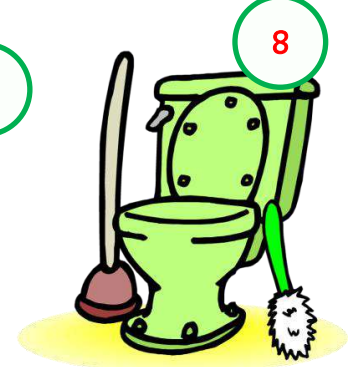

8

PLACES IN A HOUSE CROSSWORD PUZZLE

Look at the numbers on the pictures and write the places in a house vocabulary in the crossword puzzle

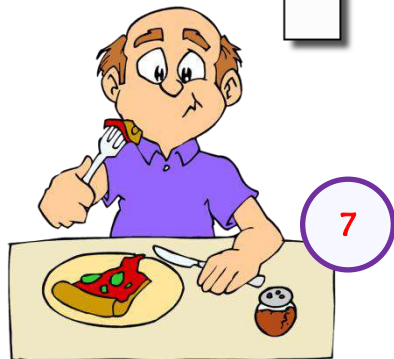
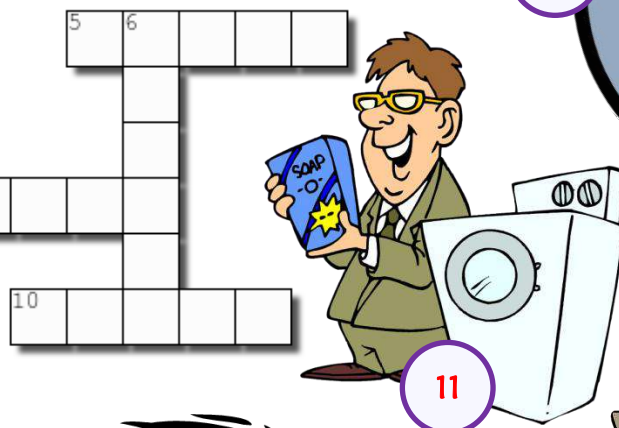
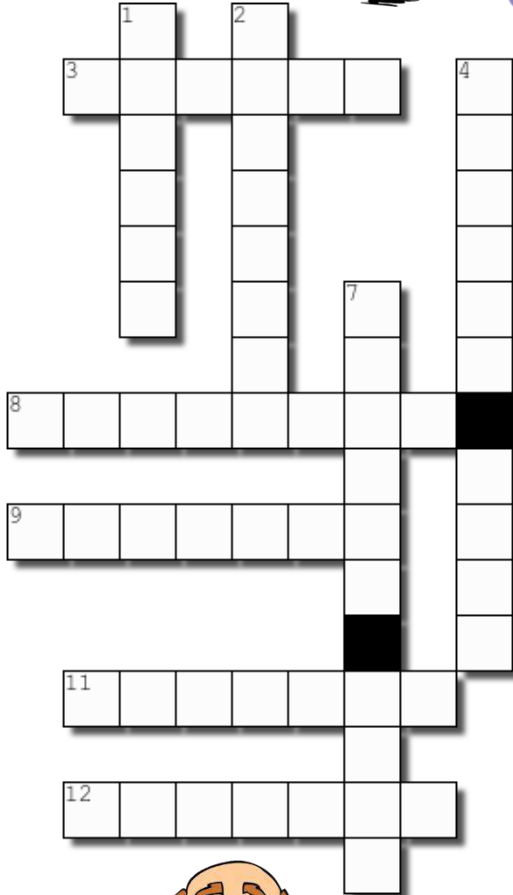
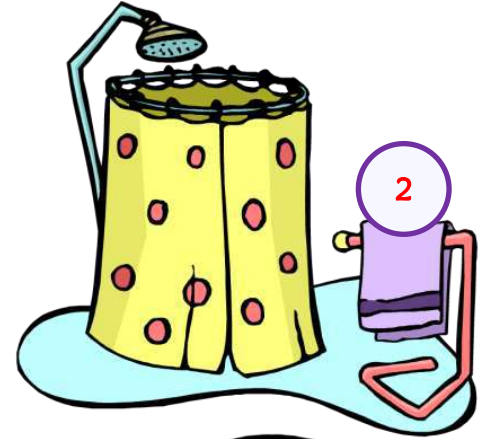
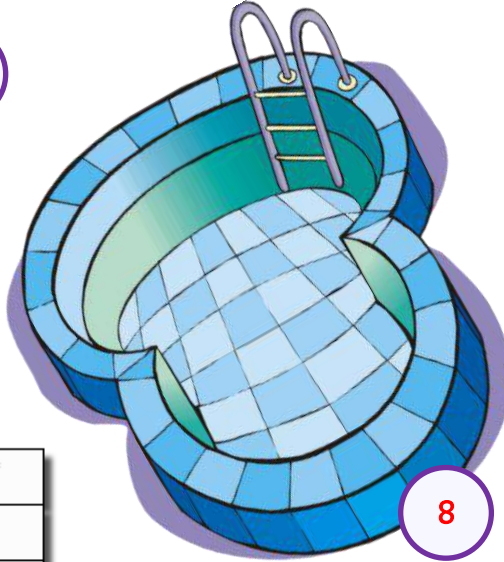

ANSWER KEY

Across

3. garage

5. study

8. swimming pool

9. kitchen

10. attic

11. laundry

12. bedroom

Down

1. garden

2. bathroom

4. living room

6. toilet

7. dining room

PLACES IN A HOUSE MISSING LETTERS IN WORDS

Write the missing letters in the boxes to complete the places in a house vocabulary

l_v_ng r__m



k_tch_n



b_thr__m

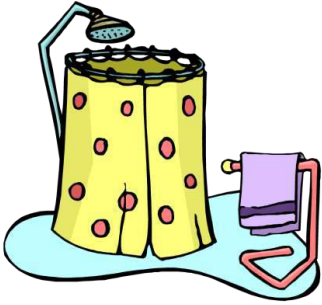

b_dr__m



d_n_ng r__m

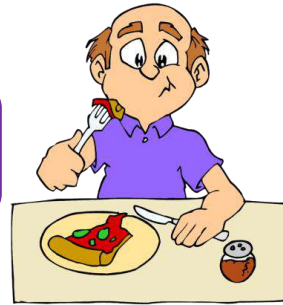

st_dy



l__ndry



t__l_t



g_rdn



g_r_g_



sw_mm_ng p__l

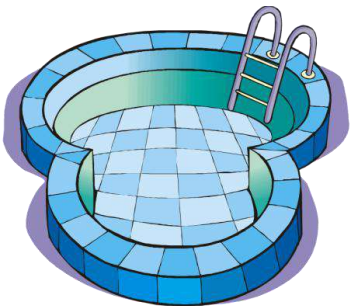

_tt_c



PLACES IN A HOUSE MISSING LETTERS IN WORDS ANSWER KEY

Write the missing letters in the boxes to complete the places in a house vocabulary

living room



kichen



bathroom

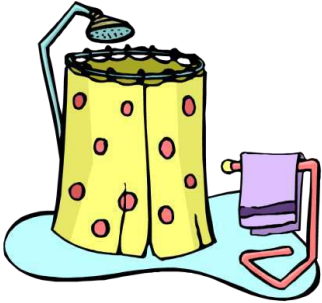

bedroom



dining room

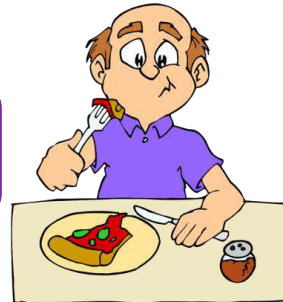

study



laundry



toilet



garden



garage



swimming pool

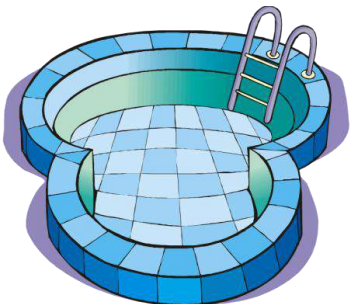

attic



PLACES IN A HOUSE UNSCRAMBLE THE WORDS

Unscramble the places in a house vocabulary and number the pictures

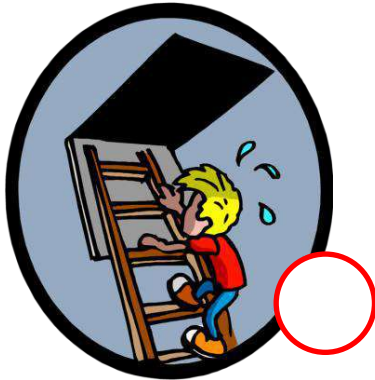
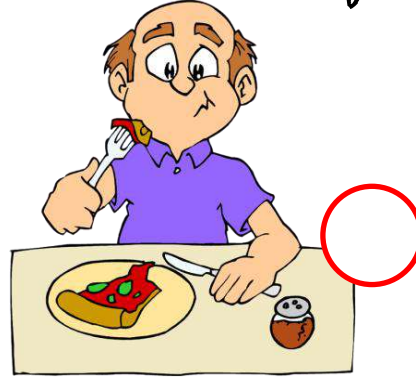
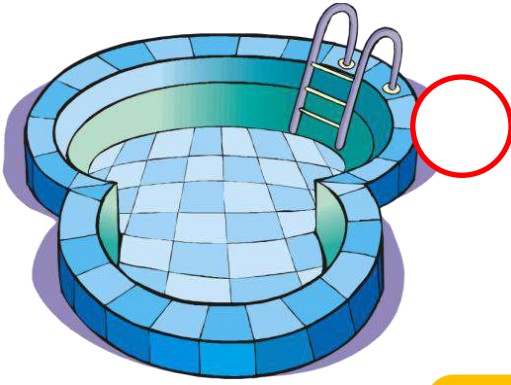

1. ignliv moor _____

2. ckehtin _____

3. moeodrb _____

4. omoathbr _____

5. gindin moro _____

6. tuyds _____

7. aurnydl _____

8. oteilt _____

9. raegdn _____

10. aregga _____

11. smngwiim oolp _____

12. atcti _____

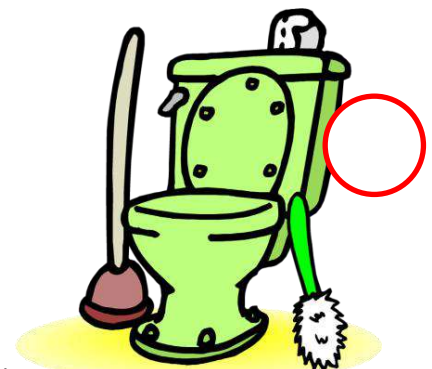
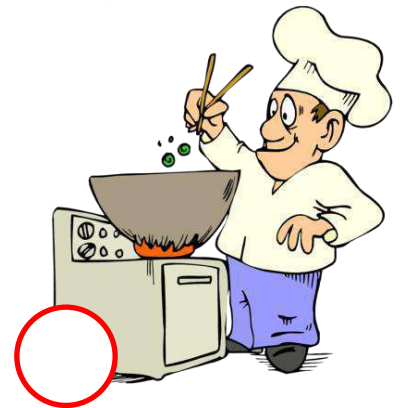
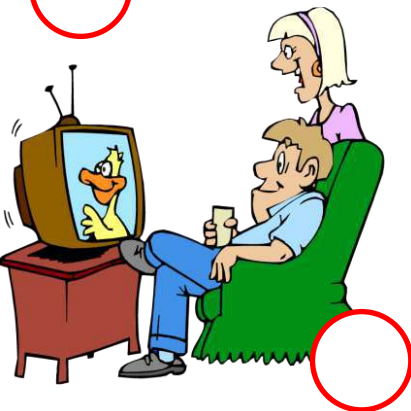
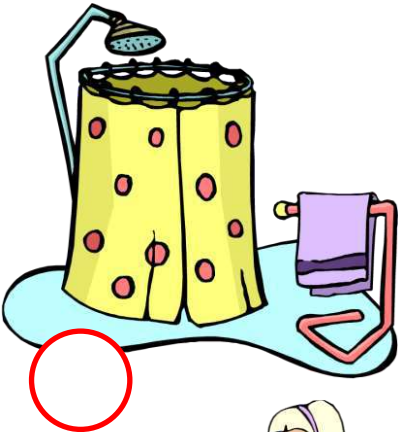

PLACES IN A HOUSE UNSCRAMBLE THE WORDS ANSWER KEY

Unscramble the places in a house vocabulary and number the pictures

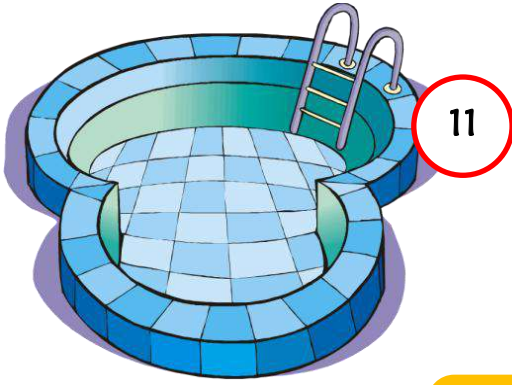

11

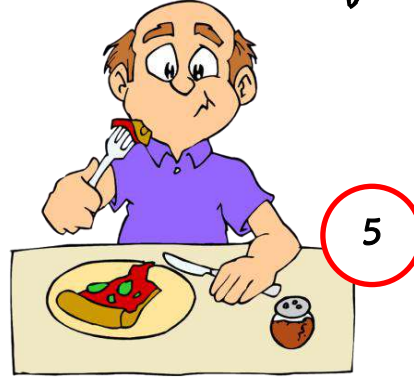

5



9



12

1. ignliv moor **living room**

2. ckehtin **kitchen**

3. moeodrb **bedroom**

4. omoathbr **bathroom**

5. gindin moro **dining room**

6. tuyds **study**

7. aurnydl **laundry**

8. oteilt **toilet**

9. raegdn **garden**

10. aregga **garage**

11. smngwiim oolp **swimming pool**

12. atcti **attic**



6

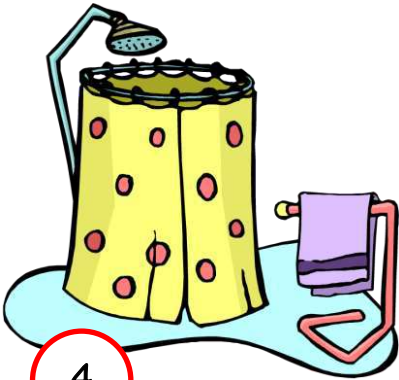

4



7



1



2



10



3



8

PLACES IN A HOUSE MULTIPLE CHOICE TEST

Look at the pictures, choose and circle the correct option.

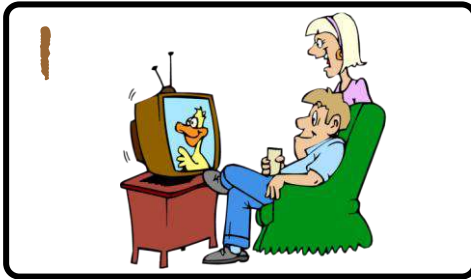

- a) bedroom
- b) bathroom
- c) dining room
- d) living room



- a) laundry
- b) study
- c) kitchen
- d) attic



- a) living room
- b) dining room
- c) bedroom
- d) bathroom

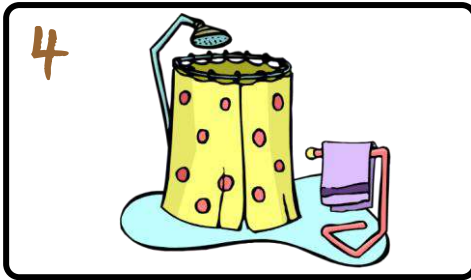

- a) bathroom
- b) bedroom
- c) living room
- d) dining room

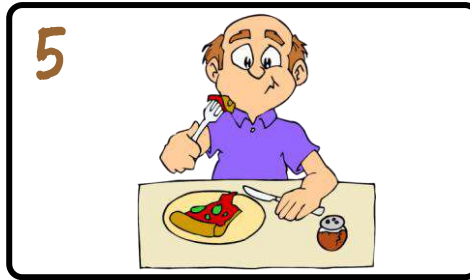

- a) living room
- b) dining room
- c) bathroom
- d) bedroom



- a) study
- b) swimming pool
- c) laundry
- d) garage



- a) garden
- b) laundry
- c) study
- d) attic



- a) attic
- b) garage
- c) swimming pool
- d) toilet



- a) laundry
- b) study
- c) garden
- d) garage



- a) garage
- b) garden
- c) toilet
- d) study

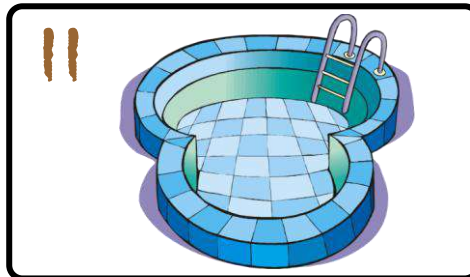

- a) laundry
- b) toilet
- c) garden
- d) swimming pool

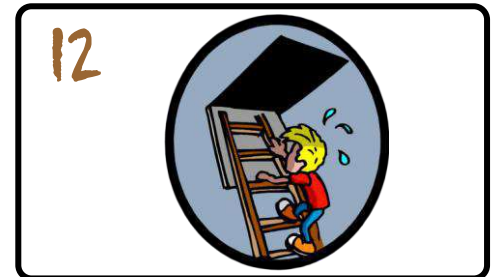

- a) toilet
- b) attic
- c) laundry
- d) study

PLACES IN A HOUSE MULTIPLE CHOICE TEST ANSWER KEY

TEST 1

- 1) d
- 2) c
- 3) c
- 4) a
- 5) b
- 6) a
- 7) b
- 8) d
- 9) c
- 10) a
- 11) d
- 12) b



living room



kitchen



bedroom

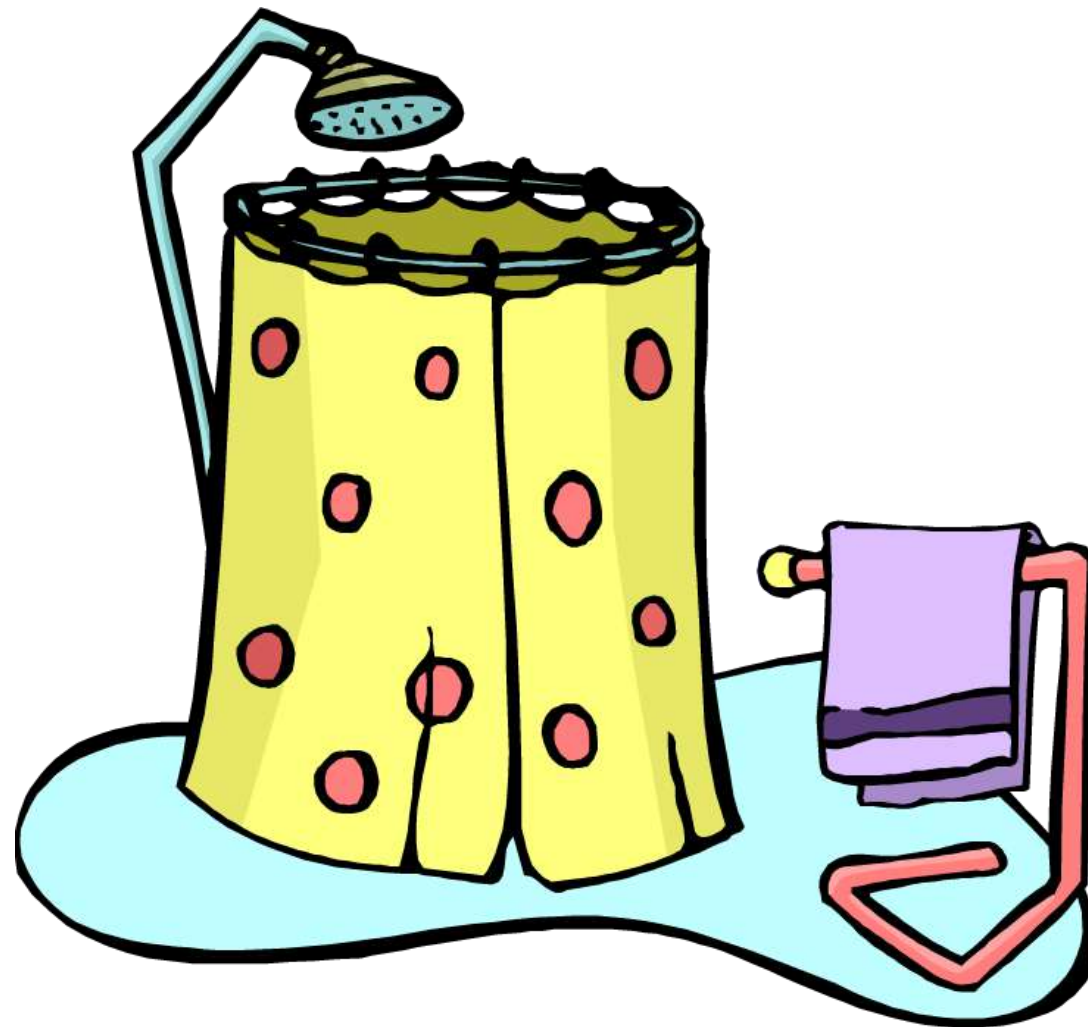

bathroom

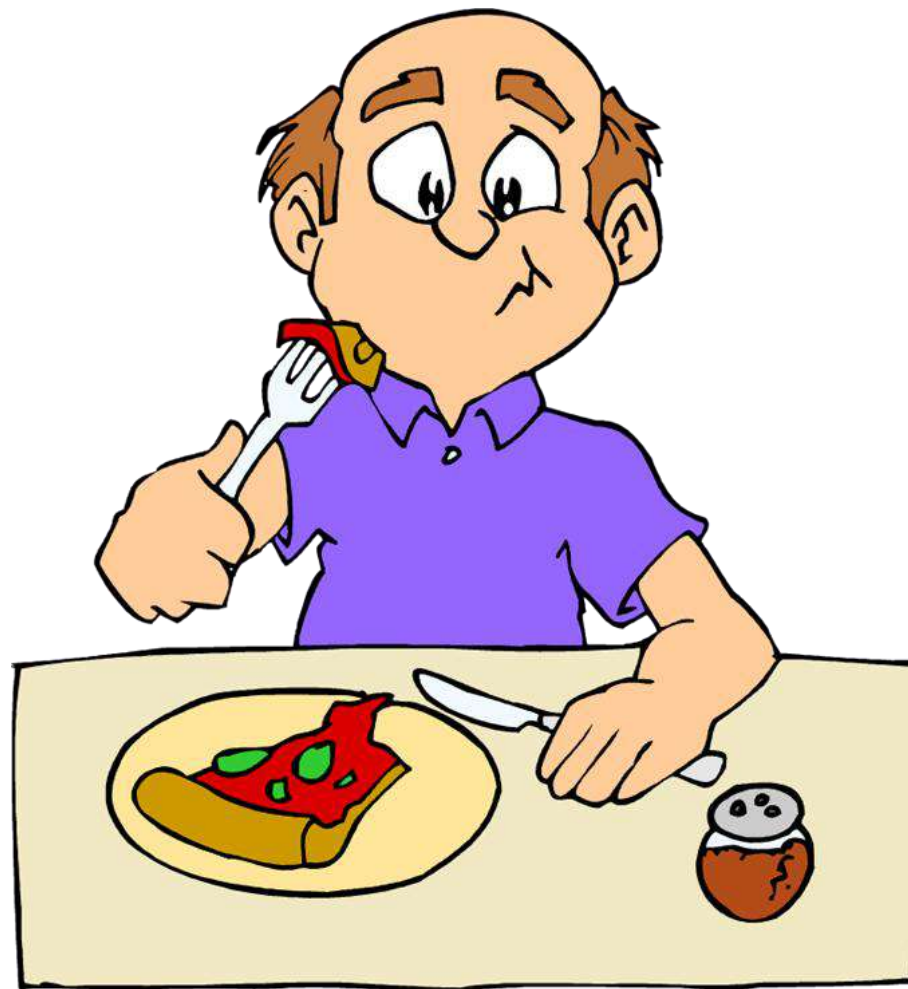

dining room



study



laundry



toilet



garden



garage

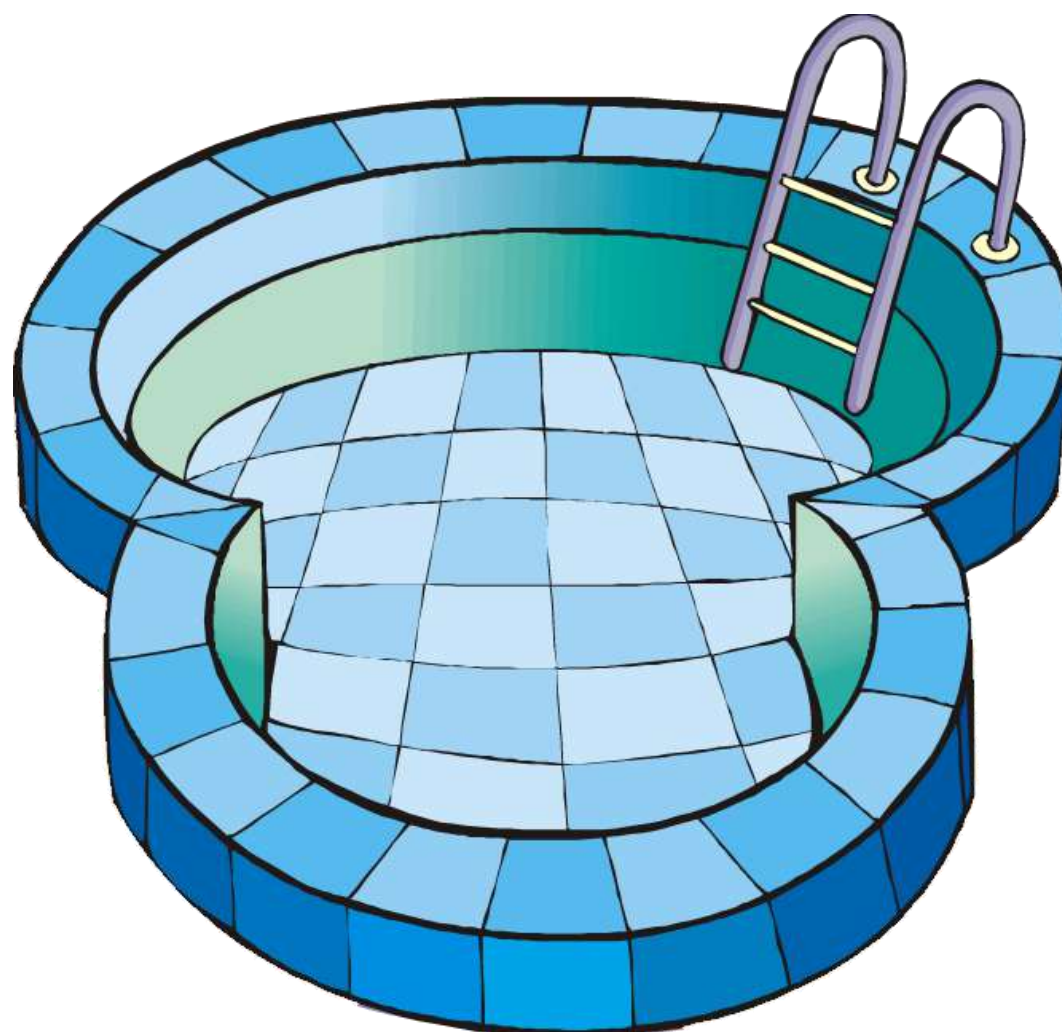

swimming pool



attic







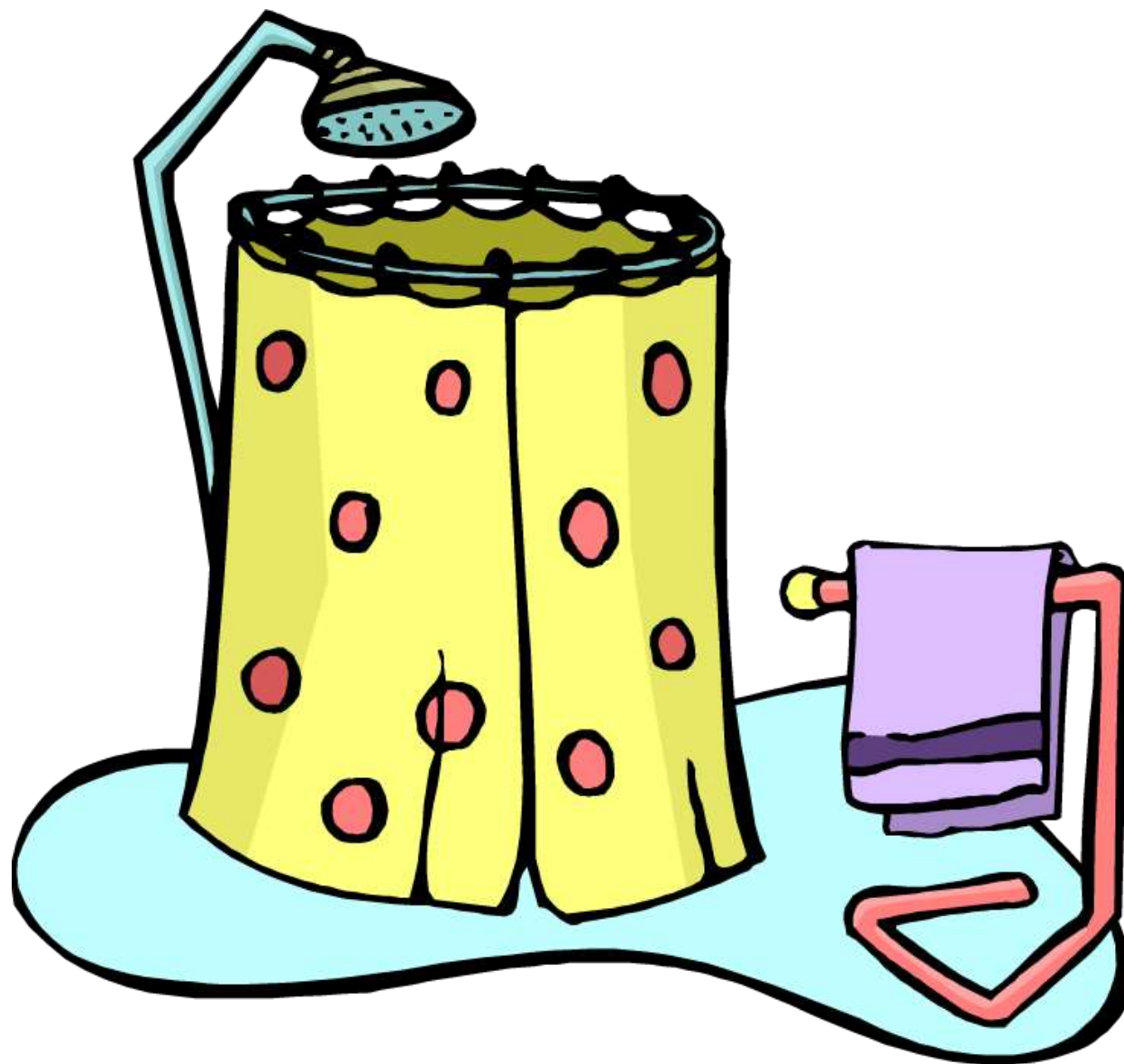

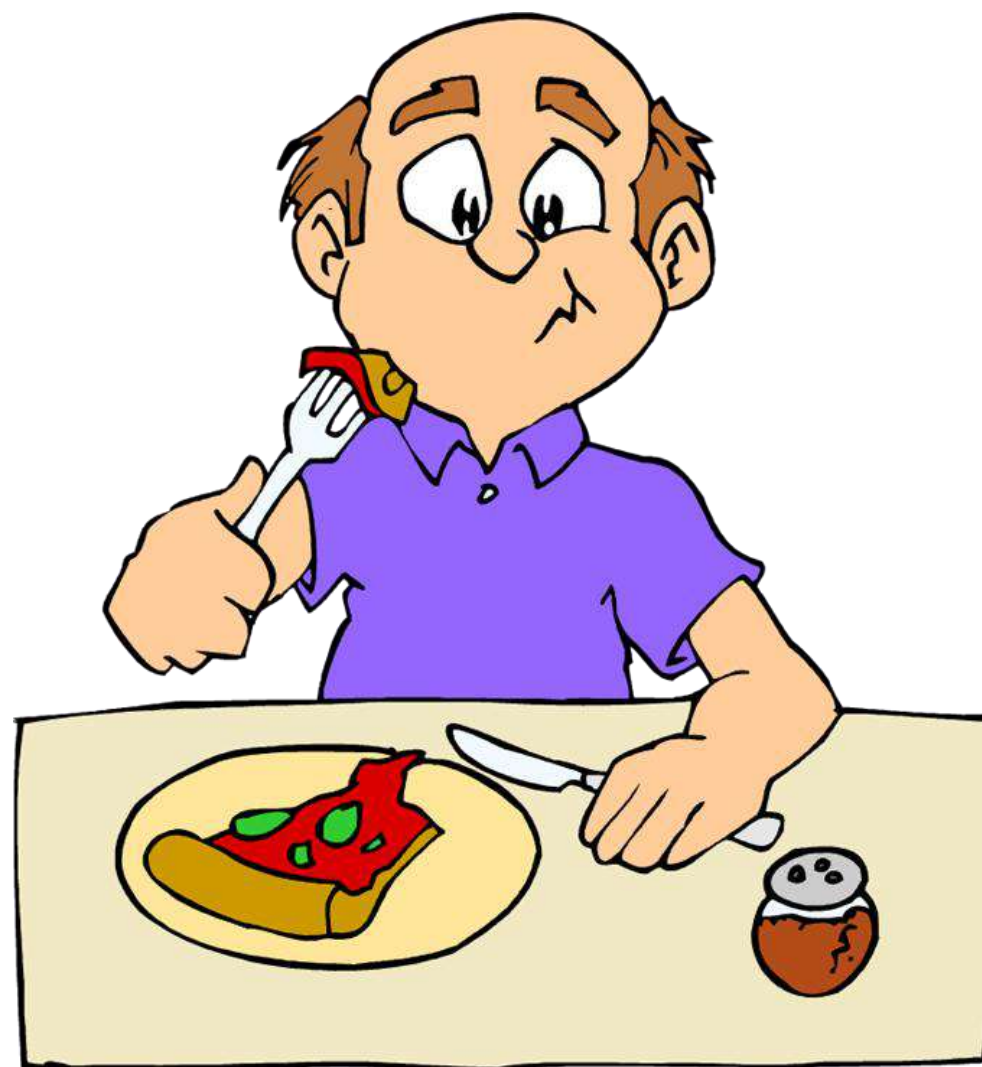











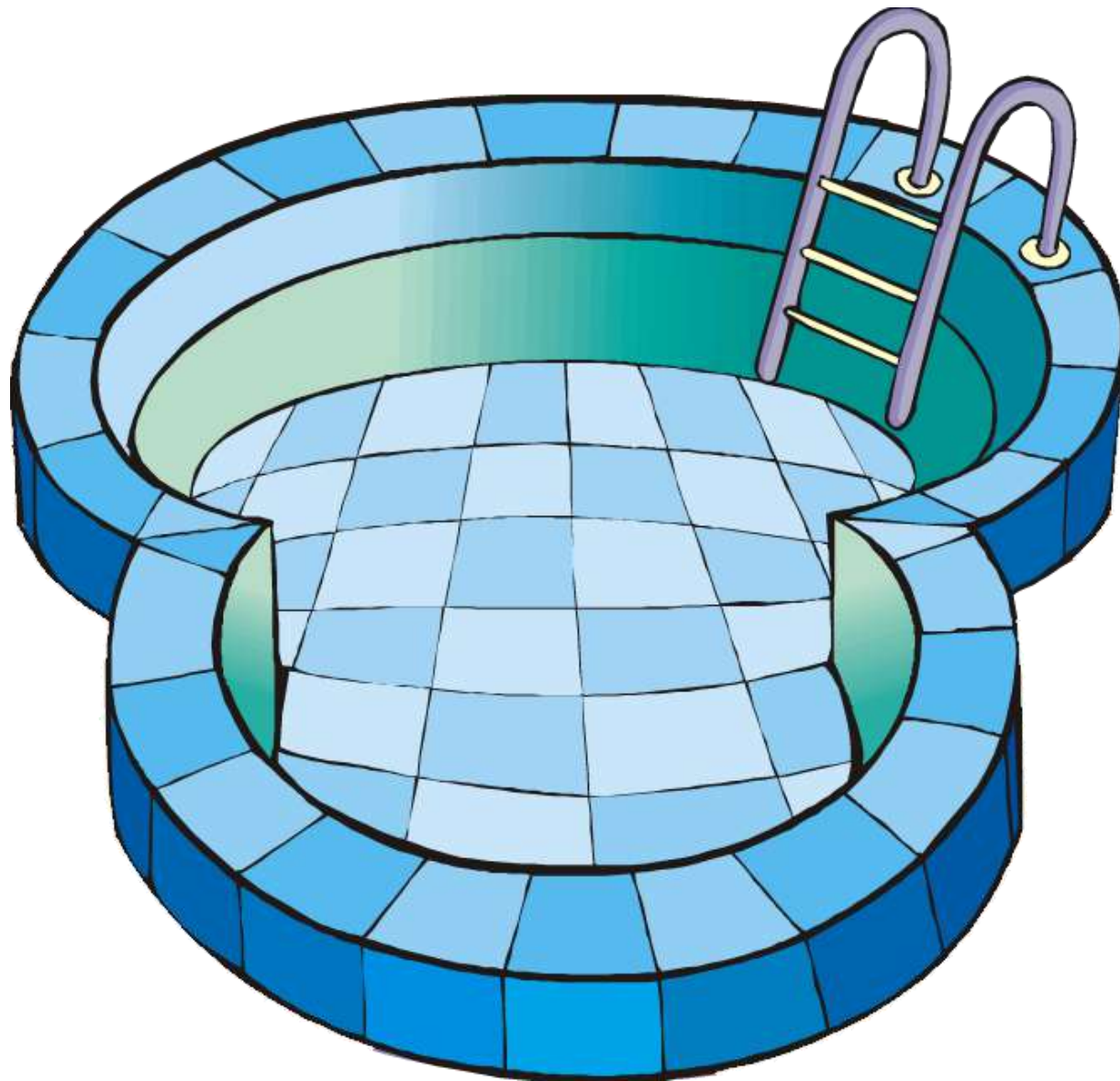



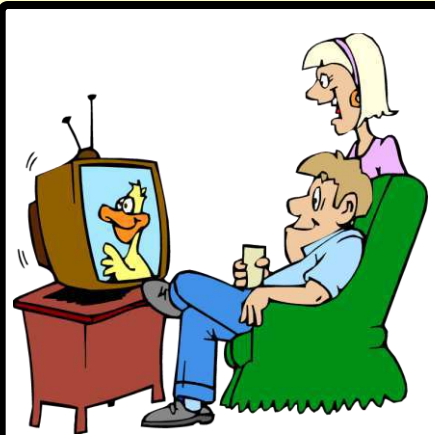

living room

Copyright © 13/10/2019 englishsheets.com. All rights reserved.



kitchen

Copyright © 13/10/2019 englishsheets.com. All rights reserved.



bedroom

Copyright © 13/10/2019 englishsheets.com. All rights reserved.

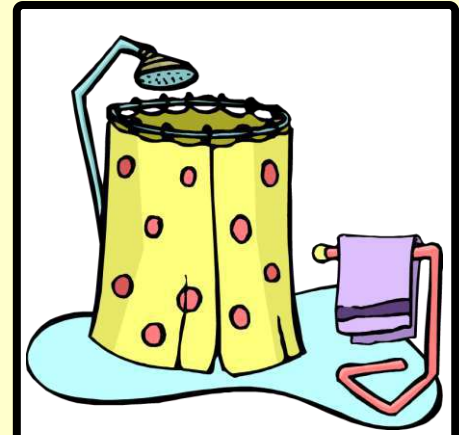

bathroom

Copyright © 13/10/2019 englishsheets.com. All rights reserved.

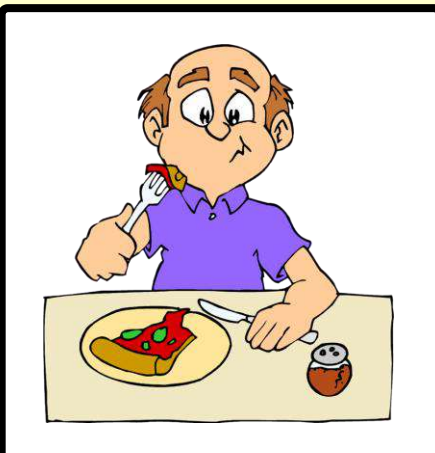

dining room

Copyright © 13/10/2019 englishsheets.com. All rights reserved.



study

Copyright © 13/10/2019 englishsheets.com. All rights reserved.



laundry

Copyright © 13/10/2019 englishsheets.com. All rights reserved.

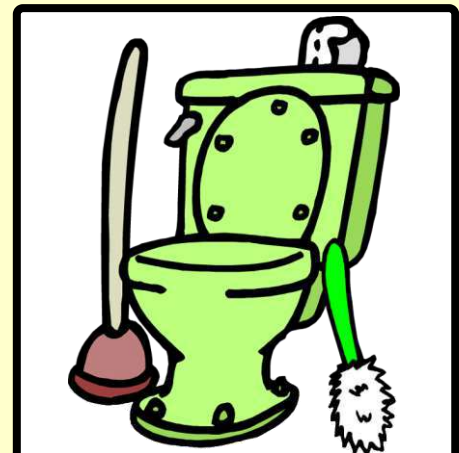

toilet

Copyright © 13/10/2019 englishsheets.com. All rights reserved.

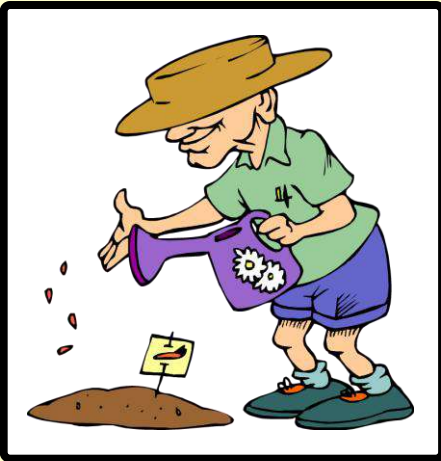

garden

Copyright © 13/10/2019 englishsheets.com. All rights reserved.

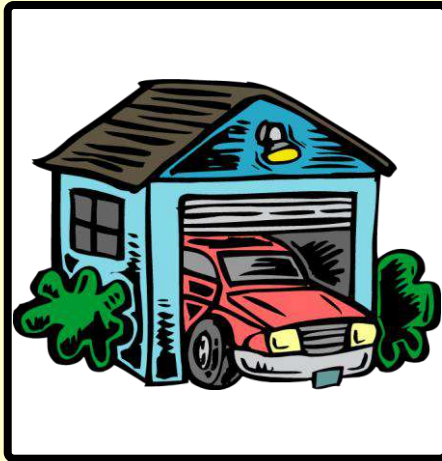

garage

Copyright © 13/10/2019 englishsheets.com. All rights reserved.

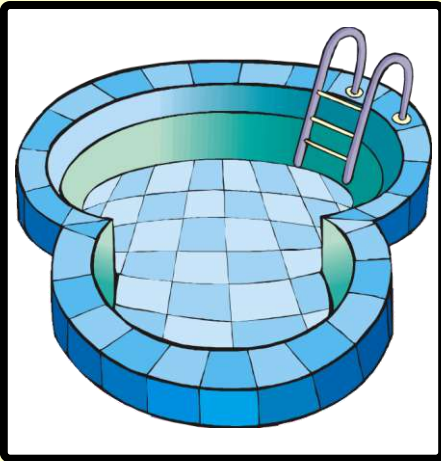

swimming pool

Copyright © 13/10/2019 englishsheets.com. All rights reserved.



attic

Copyright © 13/10/2019 englishsheets.com. All rights reserved.

PLACES IN A HOUSE FIDGET SPINNER GAME

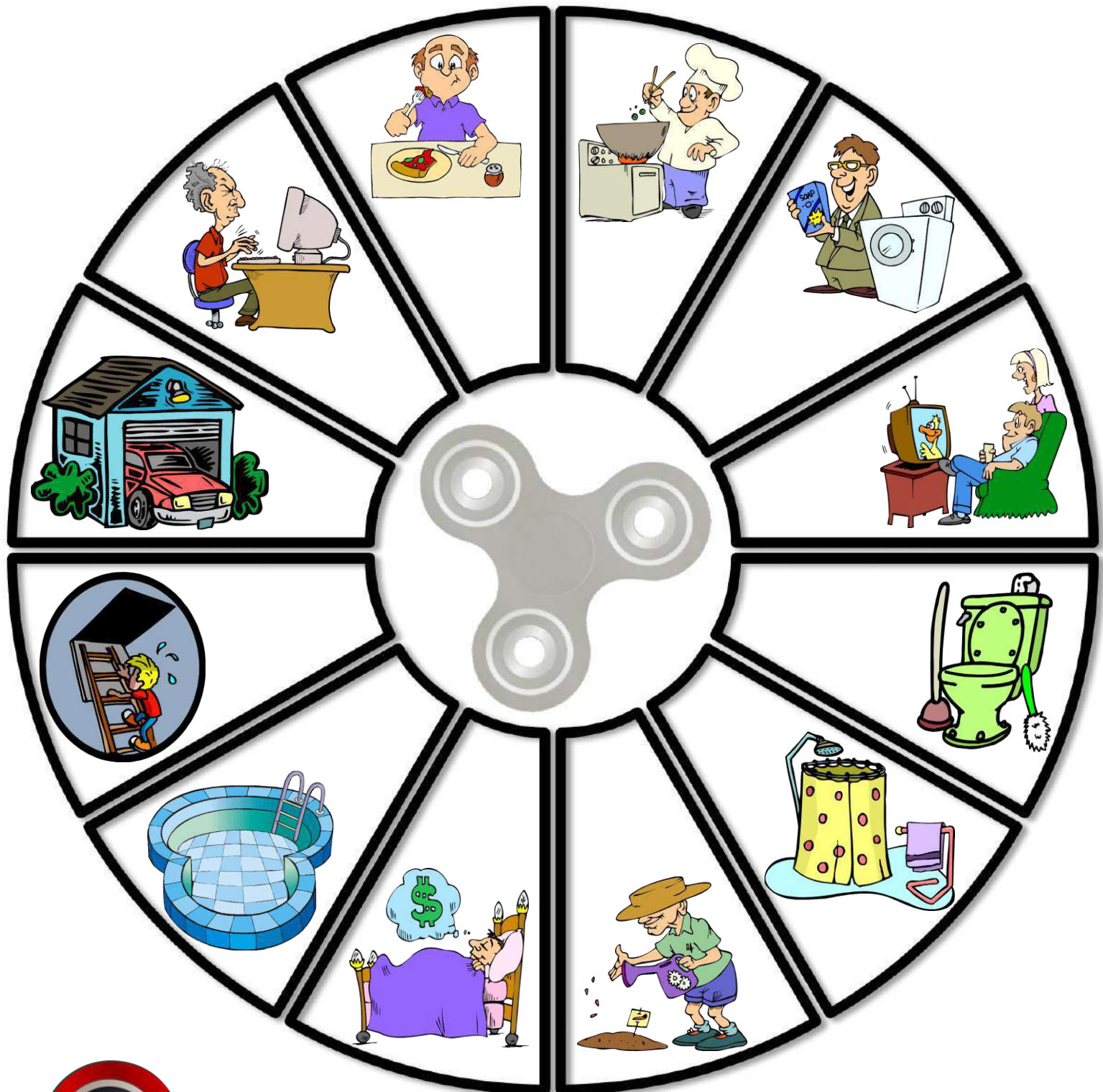

- Cut a small arrow from paper or craft foam and stick it onto the fidget spinner as your pointer.
- Place the fidget spinner in the middle of the vocabulary circle.
- Spin it and say the word quickly!



living room

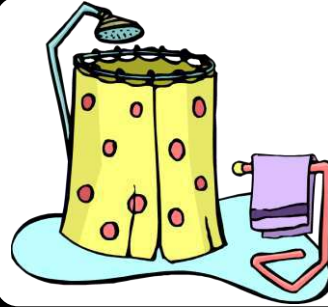

kitchen



bedroom



bathroom



dining room



study

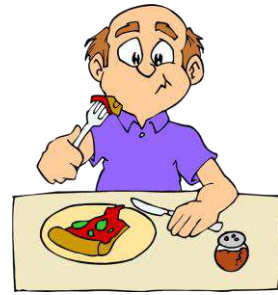

laundry



toilet

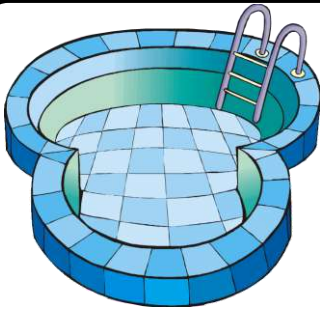

garden



garage



swimming
pool



attic

THE BREMEN TOWN MUSICIANS

Once upon a time there was a donkey, who lived on a farm with his master. One day he got fed up with working on the farm and decided to leave his master. He set off for the nearby town of Bremen.

On his way the donkey met a dog, who had also left his home and master. "Will you come with me to Bremen?" asked the donkey. "Let's become musicians in the town orchestra. You can play the drums and I will play the cello." The dog agreed and they continued on their way together.

A bit further on they met a cat and invited him to go with them to Bremen and join the town orchestra as a violinist. The cat meowed in agreement and the three animals hurried on to Bremen.

As they were passing by a castle, the three saw a cockerel, crossing as loudly as he could, so they asked him why he was singing so loudly. "They are going to cook me and eat me tomorrow," he said, "so I'm saying goodbye to life." But the donkey said, "Don't be silly! Come with us! You have a lovely voice and you could become a singer in the Bremen orchestra. That is all we are going."

The cockerel, who really didn't want to be cooked, jumped on the donkey's back and the four continued on their way.

The sun had started to go down and the four friends were looking for shelter for the night. They came across a house which was being burgled. The donkey looked through the window and saw a table, which had been generously laid with food and drinks. Since the four friends were very hungry, they decided to drive the burglars away.

The dog climbed on the donkey's back, the cat stood on the dog's head and the rooster perched on the cat's back. They started their concert on three: "Heee-haw!" brayed the donkey, "Woof-woof!" barked the dog, "Meooooowww!" said the cat and "Cock-a-doodle-doo!" crowed the cockerel.

At all the noise the burglars started shouting in fear, "Help! Ghosts are coming to get us!" The men ran out of the door as fast as they could. They wanted to leave the house that very second, thinking that the house was haunted by millions of terrifying ghosts.

The four friends made sure that the burglars had run a long way away and then went into the house. They sat down for dinner, ate, drank and were merry. Full from the delicious meal, they looked for a place to sleep and turned off the lights. The dog curled up behind the door, the cat snuggled in by the fireplace, the rooster perched on the back of a chair and the donkey settled in on one of the kitchen nooks. They soon fell fast asleep.

Meanwhile, the burglars gathered and the ringleader decided to send one of them to check whether the ghosts were still in the house as it was dark. The man who was sent approached the house quietly, shaking with fear. He reached the door and stood to listen. Since there was no noise, he went into the kitchen. He wanted to light a fire. So, thinking



the cat's glowing eyes were burning coals, he held a candle next to them, hoping it would catch light. The cat jumped on his face and started scratching him. In panic, he stepped back, stepping on the dog, who bit the man's leg fiercely. The man couldn't see anything and began to run around in the dark in a blind panic. He was kicked by the donkey. Then the cockerel crowed and started flying around.

The burglar ran to the ringleader and said "It's not just ghosts! Now there are witches in the house! Some of them scratch, others bite, others kick... It would be better for us if we moved somewhere else." When the rest of the burglars heard him, they left the place as fast as they could. So the house was left to the four good friends, who gave up their decision to become musicians and instead lived in the house for the rest of their days.

THE BREMEN TOWN MUSICIANS

COMPREHENSION QUESTIONS

1. Why did the donkey decide to leave his master?
2. Where did the donkey want to go?
3. Who did he meet on his way?
4. Why was the cockerel singing so loudly?
5. Who were in the house that four friends came across?
6. What did they do to drive those people away?
7. What did the four animals do after they went into the house?
8. Why did the ringleader send one of them to the house?
9. Did they really go to Bremen in the end?

WRITE TRUE OR FALSE

1. _____ The donkey met three animals on his way to Bremen.
2. _____ The cockerel didn't want to be killed so he decided to join the group.
3. _____ The cat could be a good singer as he had a lovely voice.
4. _____ The ringleader send one of his men to scare away the animals.
5. _____ There were actually ghosts in the house, but the animals were not afraid.



CIRCLE THE CORRECT CHOICE

1. The donkey got fed up with working on the and decided to leave his master.
mill / farm / hill
2. The could become a singer in the Bremen orchestra.
cockerel / cat / donkey
3. There was a table, which had been laid with and drinks.
guns / money / food
4. The men the door when they heard the animals' concert.
closed / ran out of / opened
5. They thought that there were millions of terrifying in the house.
ghosts / elves / magicians
6. The jumped on the man's face and started scratching him.
dog / cockerel / cat

ANSWER KEY

Comprehension Questions

1. Because he got fed up with working on the farm.
2. He wanted to go to Bremen.
3. He met a dog, a cat and a cockerel on his way.
4. Because they were going to cook and eat him.
5. The burglars were in the house that four friends came across.
6. They gave a concert and sang so loudly to drive those people away.
7. They sat down for dinner, ate, drank and slept.
8. The ringleader sent him to check whether the ghosts were still in the house.

Write True or False

1. True
2. True
3. False
4. False
5. False

Circle the Correct Choice

1. farm
2. cockerel
3. food
4. ran out of
5. ghosts
6. cat

THE BREMEN TOWN MUSICIANS

Read the texts in the boxes and number them from 1 to 8 to sequence the fairy tale



The sun had started to go down and the four friends were looking for a shelter for the night. They came across a house which was being burgled. The donkey looked through the window and saw a table, generously laid with food and drinks. Since the four friends were very hungry, they decided to drive the burglars away.



Once upon a time there was a donkey who lived on a farm with his master. One day he got fed up with working and decided to leave and go to Bremen to join the town orchestra. On his way, he met a dog, who also left his home. The donkey asked him to go to Bremen with him so that they could become musicians in the town orchestra.

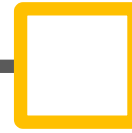

The donkey settled in on one of the kitchen nooks and they all fell fast asleep. Meanwhile, the burglars gathered and the ringleader decided to send one of them to check whether the ghosts had left. The man who was sent approached the house quietly and listened the door. Since there was no noise, he went into the kitchen. It was too dark to see.



He added that he could play the cello and the dog could play the drums. When the dog agreed, they continued their way. A bit further on, they met a cat and invited him to go with them to Bremen and join the town orchestra as a violinist. The cat accepted and the three animals hurried on to Bremen. On their way they came across a castle.



The four friends made sure that the burglars had run a long way away and then went into the house. They sat down for dinner, ate, drank and were merry. Full from the delicious meal, they looked for a place to sleep and turned off the lights. The dog curled up behind the door, the cat snuggled in by the fireplace and the cockerel perched on a chair.



The dog climbed on the donkey's back, the cat stood on the dog's head and the rooster perched on the cat's back. They started their concert and sang as loudly as they could. At all the noise the burglars started shouting in fear. They thought that ghosts were coming to get them so they ran out of the door as fast as they could.



While trying to light a candle, he disturbed the cat. All the animals woke up and attacked him. The burglar ran to the ringleader and told him that there were also witches in the house. The burglars left the place for good. The four friends changed their decisions to become musicians and lived in the house happily for the rest of their lives.

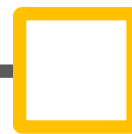

There they saw a cockerel, who was singing so loudly. His master was going to cook and eat him and he was saying goodbye to life. The donkey wanted him to come as he had a lovely voice and he could become a singer in the town orchestra. As he didn't want to be cooked, he jumped on the donkey's back and the four continued walking.

THE BREMEN TOWN MUSICIANS

Read the texts in the boxes and number them from 1 to 8 to sequence the fairy tale

4

The sun had started to go down and the four friends were looking for a shelter for the night. They came across a house which was being burgled. The donkey looked through the window and saw a table, generously laid with food and drinks. Since the four friends were very hungry, they decided to drive the burglars away.

1

Once upon a time there was a donkey who lived on a farm with his master. One day he got fed up with working and decided to leave and go to Bremen to join the town orchestra. On his way, he met a dog, who also left his home. The donkey asked him to go to Bremen with him so that they could become musicians in the town orchestra.

7

The donkey settled in on one of the kitchen nooks and they all fell fast asleep. Meanwhile, the burglars gathered and the ringleader decided to send one of them to check whether the ghosts had left. The man who was sent approached the house quietly and listened the door. Since there was no noise, he went into the kitchen. It was too dark to see.

2

He added that he could play the cello and the dog could play the drums. When the dog agreed, they continued their way. A bit further on, they met a cat and invited him to go with them to Bremen and join the town orchestra as a violinist. The cat accepted and the three animals hurried on to Bremen. On their way they came across a castle.

6

The four friends made sure that the burglars had run a long way away and then went into the house. They sat down for dinner, ate, drank and were merry. Full from the delicious meal, they looked for a place to sleep and turned of the lights. The dog curled up behind the door, the cat snuggled in by the fireplace and the cockerel perched on a chair.

5

The dog climbed on the donkey's back, the cat stood on the dog's head and the rooster perched on the cat's back. They started their concert and sang as loudly as they could. At all the noise the burglars started shouting in fear. They thought that ghosts were coming to get them so they ran out of the door as fast as they could.

8

While trying to light a candle, he disturbed the cat. All the animals woke up and attacked him. The burglar ran to the ringleader and told him that there were also witches in the house. The burglars left the place for good. The four friends changed their decisions to become musicians and lived in the house happily for the rest of their lives.

3

There they saw a cockerel, who was singing so loudly. His master was going to cook and eat him and he was saying goodbye to life. The donkey wanted him to come as he had a lovely voice and he could become a singer in the town orchestra. As he didn't want to be cooked, he jumped on the donkey's back and the four continued walking.

ANSWER KEY

